

DS9308

Imaging Scanner



Product Reference Guide



ZEBRA

Copyright

ZEBRA and the stylized Zebra head are trademarks of Zebra Technologies Corporation, registered in many jurisdictions worldwide. All other trademarks are the property of their respective owners.
©2022 Zebra Technologies Corporation and/or its affiliates. All rights reserved.

COPYRIGHTS & TRADEMARKS: For complete copyright and trademark information, go to zebra.com/copyright.

PATENT: For complete patent information, go to ip.zebra.com.

WARRANTY: For complete warranty information, go to zebra.com/warranty.

END USER LICENSE AGREEMENT: For complete EULA information, go to zebra.com/eula.

For Australia Only

For Australia Only. This warranty is given by Zebra Technologies Asia Pacific Pte. Ltd., 182 Cecil Street, #08-01 Frasers Tower, Singapore 069547. Our goods come with guarantees that cannot be excluded under the Australia Consumer Law. You are entitled to a replacement or refund for a major failure and compensation for any other reasonably foreseeable loss or damage. You are also entitled to have the goods repaired or replaced if the goods fail to be of acceptable quality and the failure does not amount to a major failure.

Zebra Technologies Corporation Australia's limited warranty above is in addition to any rights and remedies you may have under the Australian Consumer Law. If you have any queries, please call Zebra Technologies Corporation at +65 6858 0722. You may also visit our website: zebra.com for the most updated warranty terms.

Terms of Use

- Proprietary Statement

This manual contains proprietary information of Zebra Technologies Corporation and its subsidiaries ("Zebra Technologies"). It is intended solely for the information and use of parties operating and maintaining the equipment described herein. Such proprietary information may not be used, reproduced, or disclosed to any other parties for any other purpose without the express, written permission of Zebra Technologies.

- Product Improvements

Continuous improvement of products is a policy of Zebra Technologies. All specifications and designs are subject to change without notice.

- Liability Disclaimer

Zebra Technologies takes steps to ensure that its published Engineering specifications and manuals are correct; however, errors do occur. Zebra Technologies reserves the right to correct any such errors and disclaims liability resulting therefrom.

- Limitation of Liability

In no event shall Zebra Technologies or anyone else involved in the creation, production, or delivery of the accompanying product (including hardware and software) be liable for any damages whatsoever (including, without limitation, consequential damages including loss of business profits, business interruption, or loss of business information) arising out of the use of, the results of use of, or inability to use such product, even if Zebra Technologies has been advised of the possibility of such damages. Some jurisdictions do not allow the exclusion or limitation of incidental or consequential damages, so the above limitation or exclusion may not apply to you.

Revision History

Changes to the original guide are listed below:

Change	Date	Description
-01 Rev A	09/2019	Initial release.
-02 Rev A	12/2019	Updated defaults for Parity and ASCII Format in Terminal Specific RS-232 Table; Replaced High Illumination barcode; Added USB CDC Host Variant.
-03EN Rev A	6/2020	<ul style="list-style-type: none">- Updated Data Formatting: ADF, MDF, Preferred Symbol- Updated Electronic Article Surveillance (EAS)- Updated 123Scan Requirements- Updated Zebra copyright statement- Added USB Certification in Table 6.
-04EN Rev A	4/2021	<ul style="list-style-type: none">- Added Special Tones, Data Parsing, Custom Tones- Updated Digimarc chapter- Removed Provide Documentation Feedback.
-05EN Rev A	3/2023	<ul style="list-style-type: none">- Added Weblink QR to Symbologies- Added Note to Decoding Illumination

Table of Contents

Copyright	2
For Australia Only	2
Terms of Use	2
Revision History	3
Table of Contents	4
List of Figures	20
List of Tables	21
About This Guide	
Introduction	23
Configurations	23
Accessories	24
Chapter Descriptions	25
Notational Conventions	26
Related Documents and Software	27
Service Information	27
Getting Started	
Introduction	28
Interfaces	29
Unpacking	29
Features	30
Setting Up the Scanner	31
Inserting the Interface Cable	31
Removing the Interface Cable	32
Connecting Power (if required)	33
Configuring the Scanner	33
Mounting the Scanner	33
Multi-Mount Bracket	33
Installing Multi-Mount With Adhesive Pad	33

Table of Contents

Installing Multi-Mount With Screws on Table	34
Installing Multi-Mount with Screws on Wall	35
Locking Table Mount	36
Installing Locking Table Mount	36
Removing DS9308 from Locking Table Mount	38
123Scan and Software Tools	
Introduction	39
123Scan	39
Communication with 123Scan	40
123Scan Requirements	40
123Scan Information	40
Scanner SDK, Other Software Tools, and Videos	41
Data Capture	
Introduction	42
Beeper and LED Indicators	42
Scanning	45
Hands-free Scanning	45
Hand-held Scanning	45
Aiming	46
Decode Ranges	47
Electronic Article Surveillance (EAS)	47
Installing	47
Checkpoint EAS Model Compatibility	47
Considerations	47
Checkpoint Contact Information	48
Maintenance, Troubleshooting, and Technical Specifications	
Introduction	49
Maintenance	49
Known Harmful Ingredients	49
Approved Cleaners for the Scanner	49
Cleaning the Scanner	50
Troubleshooting	51
Report Product Information	54
Report Software Version	54
Report Serial Number	54
Report Manufacturing Information	54
Technical Specifications	55
Scanner Signal Descriptions	58
User Preferences & Miscellaneous Options	
Introduction	59
Setting Parameters	59
Scanning Sequence Examples	59
Errors While Scanning	60

Table of Contents

User Preferences/Miscellaneous Options Parameter Defaults	60
Standard User Preferences	62
Default Parameters	62
Write to Custom Defaults	62
Parameter Barcode Scanning	63
Beep After Good Decode	63
Beep Volume	64
Beep Tone	65
Standard Beep Tones	65
Special Tones	66
Beep Duration	67
Volume Adjustment Trigger Timeout	68
Suppress Power Up Beeps	69
Direct Decode Indicator	70
Low Power Mode	71
Time Delay to Low Power Mode	72
Trigger Mode	74
Hand-held Decode Aiming Pattern	75
Presentation (Hands-free) Decode Aiming Pattern	76
Momentary Trigger Mode Timeout	77
Picklist Mode	78
Continuous Barcode Read	79
Unique Barcode Reporting	79
Decode Session Timeout	80
Timeout Between Decodes, Same Symbol	80
Timeout Between Decodes, Different Symbols	81
Triggered Timeout, Same Symbol	81
Mobile Phone/Display Mode	82
PDF Prioritization	83
PDF Prioritization Timeout	84
Decoding Illumination	84
Illumination Brightness	85
Motion Tolerance (Hand-held Trigger Modes Only)	86
Product ID (PID) Type	86
Product ID (PID) Value	87
ECLevel	87
Miscellaneous Scanner Parameters	88
Enter Key	88
Tab Key	88
Transmit Code ID Character	89
Prefix/Suffix Values	90
Scan Data Transmission Format	91
FN1 Substitution Values	93
Transmit "No Read" Message	94
Unsolicited Heartbeat Interval	95
securPharm Decoding	96
securPharm Output Formatting	97
Sample GS1 Format	97
Sample IFA Format	98
securPharm Output Formatting Barcodes	99

Imager Preferences

Introduction 100

Setting Parameters 100

 Scanning Sequence Examples 101

 Errors While Scanning 101

Image Capture Preferences Parameter Defaults 101

Image Capture Preferences 103

 Operational Modes 103

 Decode Mode 103

 Snapshot Mode 103

Image Capture Illumination 104

Image Capture Autoexposure 104

Fixed Exposure 105

Analog and Digital Gain 106

 Analog Gain 106

 Digital Gain 106

Gain/Exposure Priority for Snapshot Mode 107

Snapshot Mode Timeout 108

Snapshot Aiming Pattern 109

Silence Operational Mode Changes 109

Image Cropping 110

Crop to Pixel Addresses 110

Image Size (Number of Pixels) 112

Image Brightness (Target White) 113

JPEG Image Options 113

JPEG Quality Value 114

JPEG Size Value 114

Image Enhancement 115

Image File Format Selector 116

Image Rotation 117

Bits Per Pixel 118

Signature Capture 119

 Output File Format 119

Signature Capture File Format Selector 120

Signature Capture Bits Per Pixel 121

Signature Capture Width 122

Signature Capture Height 122

Signature Capture JPEG Quality 122

Symbologies

Introduction 124

Setting Parameters 124

 Scanning Sequence Examples 125

 Errors While Scanning 125

Symbology Parameter Defaults 125

Enable/Disable All Code Types 132

UPC/EAN/JAN 132

 UPC-A 132

 UPC-E 133

 UPC-E1 133

Table of Contents

EAN-8/JAN-8	134
EAN-13/JAN-13	134
Bookland EAN	135
Bookland ISBN Format	136
ISSN EAN	137
Decode UPC/EAN/JAN Supplementals	138
User-Programmable Supplementals	141
UPC/EAN/JAN Supplemental Redundancy	141
UPC/EAN/JAN Supplemental AIM ID Format	142
Transmit UPC-A Check Digit	143
Transmit UPC-E Check Digit	143
Transmit UPC-E1 Check Digit	144
UPC-A Preamble	145
UPC-E Preamble	146
UPC-E1 Preamble	147
Convert UPC-E to UPC-A	148
Convert UPC-E1 to UPC-A	148
EAN/JAN Zero Extend	149
UCC Coupon Extended Code	149
Coupon Report	150
UPC Reduced Quiet Zone	151
Code 128	151
Set Lengths for Code 128	152
GS1-128 (formerly UCC/EAN-128)	153
ISBT 128	154
ISBT Concatenation	154
Check ISBT Table	155
ISBT Concatenation Redundancy	156
Code 128 <FNC4>	156
Code 128 Security Level	157
Code 128 Reduced Quiet Zone	158
Code 39	158
Trioptic Code 39	159
Convert Code 39 to Code 32	159
Code 32 Prefix	160
Set Lengths for Code 39	160
Code 39 Check Digit Verification	162
Transmit Code 39 Check Digit	162
Code 39 Full ASCII Conversion	163
Code 39 Security Level	164
Code 39 Reduced Quiet Zone	165
Code 93	165
Set Lengths for Code 93	166
Code 11	168
Set Lengths for Code 11	168
Code 11 Check Digit Verification	170
Transmit Code 11 Check Digits	171
Interleaved 2 of 5 (ITF)	171
Set Lengths for Interleaved 2 of 5	172
I 2 of 5 Check Digit Verification	173
Transmit I 2 of 5 Check Digit	174

Table of Contents

Convert I 2 of 5 to EAN-13	174
Febraban	175
I 2 of 5 Security Level	176
I 2 of 5 Reduced Quiet Zone	177
Discrete 2 of 5 (DTF)	177
Set Lengths for Discrete 2 of 5	178
Codabar (NW - 7)	180
Set Lengths for Codabar	180
CLSI Editing	182
NOTIS Editing	182
Codabar Security Level	183
Codabar Upper or Lower Case Start/Stop Characters	184
Codabar Mod 16 Check Digit Verification	184
Transmit Codabar Check Digit	185
MSI	185
Set Lengths for MSI	186
MSI Check Digits	188
Transmit MSI Check Digit(s)	188
MSI Check Digit Algorithm	190
MSI Reduced Quiet Zone	190
Chinese 2 of 5	191
Matrix 2 of 5	191
Set Lengths for Matrix 2 of 5	192
Matrix 2 of 5 Check Digit	194
Transmit Matrix 2 of 5 Check Digit	194
Korean 3 of 5	195
Inverse 1D	195
GS1 DataBar	197
GS1 DataBar Omnidirectional (formerly GS1 DataBar-14), GS1 DataBar Truncated, GS1 DataBar Stacked, GS1 DataBar Stacked Omnidirectional	197
GS1 DataBar Limited	198
GS1 DataBar Expanded, GS1 DataBar Expanded Stacked	198
Convert GS1 DataBar to UPC/EAN/JAN	199
GS1 DataBar Security Level	200
GS1 DataBar Limited Margin Check	201
Symbology-Specific Security Features	202
Redundancy Level	202
Security Level	204
1D Quiet Zone Level	205
Intercharacter Gap Size	206
Composite	206
Composite CC-C	206
Composite CC-A/B	207
Composite TLC-39	207
Composite Inverse	207
UPC Composite Mode	209
Composite Beep Mode	210
GS1-128 Emulation Mode for UCC/EAN Composite Codes	210
2D Symbologies	211
PDF417	211
MicroPDF417	211

Table of Contents

Code 128 Emulation	212
Data Matrix	213
GS1 Data Matrix	213
Data Matrix Inverse	214
Decode Data Matrix Mirror Images	215
Maxicode	216
QR Code	216
Weblink QR	217
GS1 QR	218
MicroQR	218
Linked QR Mode	219
Aztec	220
Aztec Inverse	220
Han Xin	221
Han Xin Inverse	221
Grid Matrix	222
Grid Matrix Inverse	222
Grid Matrix Mirror	223
DotCode	224
DotCode Inverse	225
DotCode Mirrored	226
DotCode Prioritize	227
Macro PDF Features	227
Flush Macro Buffer	228
Abort Macro PDF Entry	228
Postal Codes	228
US Postnet	228
US Planet	229
Transmit US Postal Check Digit	229
UK Postal	230
Transmit UK Postal Check Digit	230
Japan Postal	231
Australia Post	231
Australia Post Format	232
Netherlands KIX Code	233
USPS 4CB/One Code/Intelligent Mail	233
UPU FICS Postal	234
Mailmark	234
USB Interface	
Introduction	235
Setting Parameters	235
Scanning Sequence Examples	235
Errors While Scanning	235
Connecting a USB Interface	236
USB Parameter Defaults	237
USB Host Parameters	239
USB Device Type	239
Symbol Native API (SNAPI) Status Handshaking	241
USB Keystroke Delay	241

Table of Contents

USB Caps Lock Override	242
Barcodes with Unknown Characters	242
USB Convert Unknown to Code 39	243
USB Fast HID	243
USB Polling Interval	244
Keypad Emulation	246
Quick Keypad Emulation	246
Keypad Emulation with Leading Zero	247
USB Keyboard FN1 Substitution	247
Function Key Mapping	248
Simulated Caps Lock	248
Convert Case	249
USB Static CDC	250
CDC Beep on <BEL>	250
TGCS (IBM) USB Beep Directive	251
TGCS (IBM) USB Barcode Configuration Directive	251
TGCS (IBM) USB Specification Version	251
USB CDC Host Variant	252
Parameter Scanning Lockout	252
Parameter Default	252
Transmitting Data Formatting	253
ASCII Character Sets	255
SSI Interface	
Introduction	256
Communication	256
SSI Commands	257
SSI Transactions	258
General Data Transactions	258
ACK/NAK Handshaking	258
Decoded Data Transmission	259
ACK/NAK Enabled and Packeted Data	259
ACK/NAK Enabled and Unpacketed ASCII Data	259
ACK/NAK Disabled and Packeted DECODE_DATA	260
ACK/NAK Disabled and Unpacketed ASCII Data	260
Communication Summary	260
RTS/CTS Lines	260
ACK/NAK Option	260
Number of Data Bits	260
Serial Response Timeout	261
Retries	261
Baud Rate, Stop Bits, Parity, Response Timeout, ACK/NAK Handshaking	261
Errors	261
SSI Communication Notes	261
Using Time Delay to Low Power Mode with SSI	262
Encapsulation of RSM Commands/Responses over SSI	263
Command Structure	263
Response Structure	263
Example Transaction	264
Command from Host to Query Packet Size Supported by Device	264

Response from Device with Packet Size Information	264
Command from Host to Retrieve Diagnostic Information	264
Response from Device with Diagnostic Information	264
Setting Parameters	265
Scanning Sequence Examples	265
Errors While Scanning	265
Simple Serial Interface Parameter Defaults	266
SSI Host Parameters	267
Select SSI Host	267
Baud Rate	267
Parity	269
Check Parity	270
Stop Bits	270
Software Handshaking	271
Host RTS Line State	272
Decode Data Packet Format	273
Host Serial Response Timeout	274
Host Character Timeout	275
Multipacket Option	276
Interpacket Delay	277
Event Reporting	278
Decode Event	278
Boot Up Event	279
Parameter Event	280
RS-232 Interface	
Introduction	281
Setting Parameters	281
Scanning Sequence Examples	282
Errors While Scanning	282
Connecting an RS-232 Interface	282
RS-232 Parameter Defaults	283
RS-232 Host Parameters	284
RS-232 Host Types	286
Baud Rate	288
Parity	289
Stop Bits	289
Data Bits	290
Check Receive Errors	290
Hardware Handshaking	291
Software Handshaking	293
Host Serial Response Timeout	295
RTS Line State	296
Beep on <BEL>	296
Intercharacter Delay	297
Nixdorf Beep/LED Options	298
Barcodes with Unknown Characters	298
ASCII Character Sets	299

IBM Interface

Introduction 300

Setting Parameters 300

 Scanning Sequence Examples 300

 Errors While Scanning 300

Connecting an IBM 468X/469X Host 301

IBM Parameter Defaults 302

IBM Host Parameters 303

 Port Address 303

 Convert Unknown to Code 39 304

 RS-485 Beep Directive 304

 RS-485 Barcode Configuration Directive 305

 IBM-485 Specification Version 305

Keyboard Wedge Interface

Introduction 306

Setting Parameters 306

 Scanning Sequence Examples 306

 Errors While Scanning 306

Connecting a Keyboard Wedge Interface 307

Keyboard Wedge Parameter Defaults 308

Keyboard Wedge Host Parameters 309

 Keyboard Wedge Host Types 309

 Barcodes with Unknown Characters 309

 Keystroke Delay 310

 Intra-keystroke Delay 310

 Alternate Numeric Keypad Emulation 311

 Quick Keypad Emulation 311

 Simulated Caps Lock 312

 Caps Lock Override 313

 Convert Case 313

 Function Key Mapping 314

 FN1 Substitution 314

 Send Make and Break 315

Keyboard Map 315

ASCII Character Sets 316

OCR Programming

Introduction 317

Setting Parameters 317

 Scanning Sequence Examples 318

 Errors While Scanning 318

OCR Parameter Defaults 318

OCR Programming Parameters 319

 OCR-A 319

 OCR-A Variant 320

 OCR-B 321

 OCR-B Variant 322

 MICR E13B 326

Table of Contents

US Currency Serial Number	327
OCR Orientation	327
OCR Lines	329
OCR Minimum Characters	329
OCR Maximum Characters	330
OCR Subset	330
OCR Quiet Zone	331
OCR Template	331
Required Digit (9)	332
Required Alpha (A)	332
Require and Suppress (0)	332
Optional Alphanumeric (1)	332
Optional Alpha (2)	333
Alpha or Digit (3)	333
Any Including Space & Reject (4)	333
Any except Space & Reject (5)	334
Optional Digit (7)	334
Digit or Fill (8)	334
Alpha or Fill (F)	335
Optional Space ()	335
Optional Small Special (.)	335
Other Template Operators	335
Repeat Previous (R)	339
Multiple Templates	340
Template Examples	340
OCR Check Digit Modulus	341
OCR Check Digit Multiplier	341
OCR Check Digit Validation	342
None	342
Product Add Left to Right	343
Digit Add Left to Right	344
Digit Add Right to Left	345
Product Add Right to Left Simple Remainder	345
Digit Add Right To Left Simple Remainder	346
Health Industry - HIBCC43	347
Inverse OCR	348
OCR Redundancy	349
Intelligent Document Capture (Hand-held Mode Only)	
Introduction	350
The IDC Process	350
Barcode Acceptance Test	351
Capture Region Determination	351
IDC Operating Mode = Anchored	351
IDC Operating Mode = Free-Form or Linked	352
Image Post Processing	352
Data Transmission	352
PC Application and Programming Support	352
Setting Parameters	353
Scanning Sequence Examples	353

Table of Contents

Errors While Scanning	353
Image Document Capture Parameter Defaults	354
IDC Operating Mode	355
IDC Symbology	356
IDC X Coordinate	357
IDC Y Coordinate	357
IDC Width	358
IDC Height	358
IDC Aspect	359
IDC File Format Selector	359
IDC Bits Per Pixel	360
IDC JPEG Quality	360
IDC Find Box Outline	361
IDC Minimum Text Length	361
IDC Maximum Text Length	362
IDC Captured Image Brighten	362
IDC Captured Image Sharpen	363
IDC Border Type	364
IDC Delay Time	365
IDC Zoom Limit	365
IDC Maximum Rotation	366
Quick Start	367
Sample IDC Setup	367
IDC Demonstrations	368
Anchored Mode Demo	368
Free-Form Mode Demo	368
Linked Mode Demo	368
Other Suggestions	369
Quick Start Form	369
Digimarc	
Introduction	370
Digimarc Symbology Selection	370
Picklist	370
Digimarc Digital Watermarks	371
Data Formatting: ADF, MDF, Preferred Symbol	
Introduction	372
Advanced Data Formatting (ADF)	372
Multicode Data Formatting (Hand-held Mode Only)	372
MDF in Hands-Free Mode	373
MDF Best Practices	374
Preferred Symbol	375
Data Parsing (UDI Scan+, Label Parse+ and Blood Bag Parse+)	375
Scan a UDI Label using UDI Scan+	375
Scan a GS1 Label using Label Parse+	376
Scan a Blood Bag Label using Blood Bag Parse+	376

Driver’s License Set Up (DS9308-DL)

Introduction 377

Driver’s License Parsing 378

Parsing Driver’s License Data Fields (Embedded Driver’s License Parsing) 379

 Embedded Driver’s License Parsing Criteria - Code Type 379

 Driver’s License Parse Field Barcodes 380

 AAMVA Parse Field Barcodes 382

 Parser Version ID Barcode 391

 391

User Preferences 392

 Set Default Parameter 392

 Output Gender as M or F 392

 Date Format 393

 No Separator 394

 Send Keystroke (Control Characters and Keyboard Characters) 395

 Control Characters 395

 Keyboard Characters 399

Parsing Rule Example 413

 Embedded Driver’s License Parsing ADF Example 417

Introduction 419

Custom Tone

 Downloading a Custom Tone via 123Scan 420

 Downloading a Custom Tone via Scanner SDK Sample Application 423

Parameter Defaults

Numeric Barcodes

 Cancel 441

 Numeric Barcodes 441

Alphanumeric Barcodes

 Cancel 443

 Alphanumeric Barcodes 443

ASCII Character Sets

 Introduction 460

Programming Reference

 Symbol Code Identifiers 471

 AIM Code Identifiers 472

Communication Protocol Functionality

 Functionality Supported via Communication (Cable) Interface 478

Country Codes	
Introduction	480
USB and Keyboard Wedge Country Keyboard Types (Country Codes)	481
Country Code Pages	
Introduction	496
Country Code Page Defaults	496
Country Code Page Barcodes	500
CJK Decode Control	
Introduction	510
CJK Control Parameters	510
Unicode Output Control	510
CJK Output Method to Windows Host	511
Non-CJK UTF Barcode Output	513
Country Keyboard Type Missing Characters	513
Unicode/CJK Decode Setup with Windows Host	514
Setting Up the Windows Registry Table for Unicode Universal Output	514
Adding CJK IME on Windows	514
Selecting the Simplified Chinese Input Method on the Host	516
Selecting the Traditional Chinese Input Method on the Host	517
Signature Capture	
Introduction	518
Code Structure	518
Signature Capture Area	518
CapCode Pattern Structure	519
Start / Stop Patterns	519
Dimensions	520
Data Format	520
Additional Capabilities	521
Signature Boxes	521
Non-Parameter Attributes (Attribute Data Dictionary)	
Introduction	522
Attributes	522
Model Number	522
Serial Number	522
Date of Manufacture	523
Date of First Programming	523
Configuration Filename	523
Beeper/LED	524
Parameter Defaults	525
Parameter Buffer	525
Beep on Next Bootup	525
Reboot	525
Host Trigger Session	526

Table of Contents

Firmware Version	526
Device Class	526
Scankit Version	526
Combined Firmware Version	527
RSM Version	527
Top Level Release Name	527
Imagekit Version	527
DL Parser Version	528
DL Parser Activated	528
ScanSpeed Analytics	528
Introduction	529
Histogram Decode Information	529

ScanSpeed Analytics

Image of Slowest Decoded Barcode	533
--	-----

Sample Barcodes

UPC/EAN	535
UPC-A, 100%	535
UPC-A with 2-digit Add-on	535
UPC-A with 5-digit Add-on	536
UPC-E	536
UPC-E with 2-digit Add-on	536
UPC-E with 5-digit Add-on	537
EAN-8	537
EAN-13, 100%	537
EAN-13 with 2-digit Add-on	538
EAN-13 with 5-digit Add-on	538
Code 128	538
GS1-128	539
Code 39	539
Code 93	539
Code 11 with 2 Check Digits	540
Interleaved 2 of 5	540
MSI with 2 Check Digits	540
Chinese 2 of 5	541
Matrix 2 of 5	541
Korean 3 of 5	541
GS1 DataBar	542
GS1 DataBar Omnidirectional (formerly GS1 DataBar-14)	542
GS1 DataBar Truncated	542
GS1 DataBar Stacked	542
GS1 DataBar Stacked Omnidirectional	543
GS1 DataBar Limited	543
GS1 DataBar Expanded	543
GS1 DataBar Expanded Stacked	544
2D Symbolologies	544
PDF417	544
Data Matrix	544

Table of Contents

GS1 Data Matrix	545
Maxicode	545
QR Code	545
GS1 QR	545
MicroQR	546
Aztec	546
Grid Matrix	546
Han Xin	547
Postal Codes	547
US Postnet	547
UK Postal	547
Japan Postal	547
Australian Post	548
OCR	548
OCR-A	548
OCR-B	548
MICR E13B	548
US Currency	549

Index

List of Figures

Figure 1. DS9308 Scanner	28
Figure 2. Parts of the Scanner	30
Figure 3. Inserting the Cable	31
Figure 4. Removing the Cable	32
Figure 5. Mounting with Adhesive Pad	33
Figure 6. Securing Multi-Mount Bracket to Table	34
Figure 7. Inserting Scanner into Multi-Mount on Table	34
Figure 8. Securing Multi-Mount Bracket to Wall	35
Figure 9. Inserting Scanner into Multi-Mount on Wall	35
Figure 10. Installing Locking Table Mount Bracket	36
Figure 11. Inserting Scanner onto Locking Table Mount Bracket	37
Figure 12. Securing Scanner to Locking Mount Bracket	38
Figure 13. Removing Scanner from Locking Mount Bracket	38
Figure 14. Scanning in Hands-free Mode	45
Figure 15. Scanning in Hand-held (Momentary Trigger) Mode	45
Figure 16. Scanning Orientation with Imager Aiming Dot	46
Figure 17. Acceptable and Incorrect Aiming	46
Figure 18. Scanner Cable Pinouts	58
Figure 19. USB Connection	236
Figure 20. RS-232 Connection	282
Figure 21. IBM Connection	301
Figure 22. Keyboard Wedge Connection	307
Figure 23. IBM PS2 Type Keyboard	315
Figure 24. Quick Start Form	369
Figure 25. Scanning Label in a Horizontal Orientation	373
Figure 26. Scanning Label in a Vertical Orientation	374
Figure 27. Figure Match Setting for Output	374
Figure 28. 123Scan Utility	420
Figure 29. USB Parameter Change Window	420
Figure 30. General Parameters Section	421
Figure 31. Enable Custom Scan Tone Window	421
Figure 32. Updated General Parameters Section	422
Figure 33. Load Configuration Window	422
Figure 34. Load Configuration Complete Window	423
Figure 35. Scanner SDK C++ Sample Application	424
Figure 36. Sample Barcode	425
Figure 37. CapCode	518
Figure 38. CapCode Structure	519
Figure 39. Acceptable Signature Boxes	521
Figure 40. 123Scan Statistics Tab - Histogram Data	530

List of Tables

Table 1. DS9308 Scanner Only Configurations	23
Table 2. Scanner Accessories	24
Table 3. Scanner Beeper and LED Indications	42
Table 4. DS9308 Decode Ranges	47
Table 5. Troubleshooting	51
Table 6. Technical Specifications	55
Table 7. DS9308 Scanner Signal Pin-outs	58
Table 8. User Preferences Parameter Defaults	60
Table 9. Image Capture Preferences Parameter Defaults	101
Table 10. Image Size	112
Table 11. Output File Format	119
Table 12. Symbology Parameter Defaults	125
Table 13. USB Interface Parameter Defaults	237
Table 14. USB CDC Host Variant Parameter Values	252
Table 15. Parameter Defaults for Airport Device Types	252
Table 16. SITA Code ID	253
Table 17. ARINC Barcode Identifier	253
Table 18. SSI Commands	257
Table 19. Values for Selecting Time Delay to Low Power	262
Table 20. SSI Interface Default Table	266
Table 21. Event Codes	278
Table 22. RS-232 Interface Parameter Defaults	283
Table 23. Terminal Specific RS-232	284
Table 24. Terminal Specific Code ID Characters	285
Table 25. IBM 468X/469X Interface Parameter Defaults	302
Table 26. Keyboard Wedge Interface Parameter Defaults	308
Table 27. OCR Programming Default Table	318
Table 28. Table of Numeric Value Assignments for Computing HIBC LIC Data Format Check Digit	347
Table 29. Intelligent Document Capture (IDC) Parameter Defaults	354
Table 30. IDC Symbologies	356
Table 31. DL Parsing Parameter Table	377
Table 32. Parameter Defaults	426
Table 33. ASCII Character Set	460
Table 34. ALT Key Character Set	465
Table 35. GUI Key Character Set	466
Table 36. PF Key Character Set	467
Table 37. F Key Character Set	468
Table 38. Numeric Key Character Set	468
Table 39. Extended Key Character Set	469
Table 40. Symbol Code Characters	471
Table 41. Aim Code Characters	472
Table 42. Modifier Characters	473

List of Tables

Table 43. Communication Interface Functionality	478
Table 44. Country Code Page Defaults	496
Table 45. Missing Characters	513
Table 46. Missing Characters	514
Table 47. Start / Stop Pattern Definitions	519
Table 48. User Defined CapCode Parameters	519
Table 49. Data Format.	520
Table 50. Attributes Numbers of Barcode Symbology Statistic Information	530
Table 51. RSM Attributes to Store/Retrieve Image of Slowest Decoded Barcode	533

About This Guide

Introduction

The DS9308 scanner Product Reference Guide provides general instructions for setting up, operating, maintaining, and troubleshooting the DS9308 scanner.

Configurations

This guide includes the DS9308 scanner configurations listed in [Table 1](#).

Table 1 DS9308 Scanner Only Configurations

Configuration	Description
DS9308-SR00004ZZWW	Presentation Area Imager, Standard Range, Corded, Midnight Black
DS9308-SR00004ZCWW	Presentation Area Imager, Standard Range, Corded, Midnight Black, Checkpoint EAS
DS9308-SRD0004ZZWW	Presentation Area Imager, Standard Range, Corded, Midnight Black, Digimarc
DS9308-DL00004ZZNA	Presentation Area Imager, Standard Range, DL Parsing, Corded, Midnight Black
DS9308-DL00004ZCNA	Presentation Area Imager, Standard Range, DL Parsing, Corded, Midnight Black, Checkpoint EAS
DS9308-DLD0004ZZNA	Presentation Area Imager, Standard Range, DL Parsing, Corded, Midnight Black, Digimarc
DS9308-TT00004ZZJP	Presentation Area Imager, Standard Range, Toshiba TEC, Corded, Midnight Black
DS9308-TT00004ZCJP	Presentation Area Imager, Standard Range, Toshiba TEC, Corded, Midnight Black, Checkpoint EAS
DS9308-SR00004ZZY	Presentation Area Imager, Standard Range, Corded, Midnight Black - India Only
DS9308-SR0000WZZWW	Presentation Area Imager, Standard Range, Corded, Alpine White
DS9308-SR00004ZTWW	Presentation Area Imager, Standard Range, Corded, Midnight Black, TAA

Accessories



NOTE: Check Solution Builder for additional information regarding all available accessories, and the latest available configurations.

The scanner ships with the DS9308 Quick Start Guide. The following required accessories must be ordered:

- Interface cable for the appropriate interface. For example, a shielded connector cable when connecting via USB.
- Universal power supply, if the interface requires this.

The product configurations related to the DS9308 scanner are listed in [Table 2](#).

Table 2 Scanner Accessories

Product Type	Part Number	Description
Cables	For information about cables, cable compatibility, and the full list of supported cables go to the Zebra Partner Portal at: https://partnerportal.zebra.com/PartnerPortal/product_services/downloads_z/barcode_scanners/Universal-Cable-Guide-Bar-Code-Scanners.xlsx .	
Stands and Holders (optional)	BRKT-MM0093C-04	DS9308 Multi-mount bracket, Black. Can be used as wall mount or table mount. See Mounting the Scanner on page 33 for installation instructions.
	BRKT-LM0093C-04	DS9308 Locking-mount bracket, Black. Can be used to lock the scanner into position on a horizontal or vertical surface. See Mounting the Scanner on page 33 for installation instructions.
	BRKT-MM0093C-0W	DS9308 Multi-mount bracket, White. Can be used as wall mount or table mount. See Mounting the Scanner on page 33 for installation instructions.
	BRKT-LM0093C-0W	DS9308 Locking-mount bracket, White. Can be used to lock the scanner into position on a horizontal or vertical surface. See Mounting the Scanner on page 33 for installation instructions.
Power Supplies (if required)	PWR-WUA5V4W0US	Power Supply, 5VDC, 100 - 240VAC, US/CA/MX/JP/TW
	PWR-WUA5V4W0BR	Power Supply, 5VDC, 100 - 240VAC, KR (Korea)
	PWR-WUA5V4W0EU	Power Supply, 5VDC, 100 - 240VAC, EU/UK
	PWR-WUA5V4W0CN	Power Supply, 5VDC, 100 - 240VAC, CN
	PWR-WUA5V4W0AU	Power Supply, 5VDC, 100 - 240VAC, HK/AU

Chapter Descriptions

Topics covered in this guide are as follows:

- [Getting Started](#) provides a product overview, unpacking instructions, and cable connection information.
- [123Scan and Software Tools](#) describes the Zebra software tools available for customizing scanner operation.
- [Data Capture](#) describes parts of the scanner, beeper and LED definitions, and how to use the scanner in hand-held and hands-free (presentation) modes.
- [Maintenance, Troubleshooting, and Technical Specifications](#) provides information on how to care for the scanner, troubleshooting, and technical specifications.
- [User Preferences & Miscellaneous Options](#) describes features frequently used to customize how data transmits to the host device and programming barcodes for selecting user preference features for the scanner.
- [Imager Preferences](#) provides imaging preference features and programming barcodes for selecting these features.
- [Symbologies](#) describes all symbology features and provides programming barcodes for selecting these features for the scanner.
- [USB Interface](#) describes how to set up the scanner with a USB host.
- [SSI Interface](#) describes the system requirements of the Simple Serial Interface (SSI), which provides a communications link between Zebra decoders and a serial host.
- [RS-232 Interface](#) describes how to set up the scanner with an RS-232 host, such as point-of-sale devices, host computers, or other devices with an available RS-232 port.
- [IBM Interface](#) describes how to set up the scanner with IBM 468X/469X POS systems.
- [Keyboard Wedge Interface](#) describes how to set up a Keyboard Wedge interface with the scanner.
- [OCR Programming](#) describes how to set up the scanner for OCR programming.
- [Intelligent Document Capture \(Hand-held Mode Only\)](#) describes IDC, an advanced image processing firmware, including IDC functionality, parameter barcodes to control its features, and a quick start procedure.
- [Digimarc](#) provides barcodes to either enable or disable Digimarc Barcode, a machine-readable code that is invisible to people.
- [Data Formatting: ADF, MDF, Preferred Symbol](#) briefly describes the Zebra features available for customizing scanner operation.
- [Driver's License Set Up \(DS9308-DL\)](#) describes how the DS9308-DL scanner can parse out information from standard US driver's licenses and certain other American Association of Motor Vehicle Administrators (AAMVA) compliant ID cards.
- [Custom Tone](#) provides information about downloading a custom tone to sound when a good decode occurs.
- [Parameter Defaults](#) provides a table of all host devices and miscellaneous scanner defaults.
- [Numeric Barcodes](#) includes the numeric barcodes to scan for parameters requiring specific numeric values.
- [Alphanumeric Barcodes](#) includes the barcodes representing the alphanumeric keyboard, used when setting ADF rules.
- [ASCII Character Sets](#) provides ASCII character value tables.

- [Programming Reference](#) provides a table of AIM code identifiers, ASCII character conversions, and keyboard maps.
- [Communication Protocol Functionality](#) lists supported scanner functionality by communication protocol.
- [Country Codes](#) provides barcodes for programming the country keyboard type for the USB keyboard (HID) device and the keyboard wedge host.
- [Country Code Pages](#) provides barcodes for selecting code pages for the country keyboard type.
- [CJK Decode Control](#) describes control parameters for Unicode/CJK (Chinese, Japanese, Korean) barcode decode through USB HID Keyboard Emulation mode.
- [Signature Capture](#) provides information on CapCode, a signature capture code that encloses a signature area on a document and allows a scanner to capture a signature.
- [Non-Parameter Attributes \(Attribute Data Dictionary\)](#) defines non-parameter attributes.
- [ScanSpeed Analytics](#) describes the Zebra ScanSpeed Analytics software that allows the identification of barcodes that slow down processes.
- [Sample Barcodes](#) includes sample barcodes of various code types.

Notational Conventions

The following conventions are used in this document:

- **Bold** text is used to highlight the following:
 - Dialog box, window and screen names
 - Drop-down list and list box names
 - Check box and radio button names
 - Icons on a screen
 - Key names on a keypad
 - Button names on a screen.
- Bullets (•) indicate:
 - Action items
 - Lists of alternatives
 - Lists of required steps that are not necessarily sequential.
- Sequential lists (e.g., those that describe step-by-step procedures) appear as numbered lists.

Related Documents and Software

- DS9308 Quick Start Guide, p/n MN-003533-xx, provides general information for getting started with the DS9308 scanner, and includes basic set up and operation instructions.
- Advanced Data Formatting Programmer Guide, p/n 72E-69680-xx - provides information on ADF, a means of customizing data before transmission to a host.
- Multicode Data Formatting and Preferred Symbol (MDF) User Guide, p/n MN-002895-xx, provides programming instructions for using MDF and Preferred Symbol on the DS9308 scanner.
- Plural Stage Programmer's Guide, p/n 72E-67113-xx, provides the barcodes necessary to program the DS9308 scanner to decode Plural Stage barcodes and enable Supplemental Recognition Characters.
- Toshiba TEC Programmer's Guide, p/n MN-002707-xx, provides the barcodes necessary to program the DS9308 scanner for the Toshiba TEC host.

For the latest version of this guide and all guides, go to: zebra.com/support.

Service Information

If you have a problem with your equipment, contact Zebra Global Customer Support for your region. Contact information is available at: zebra.com/support.

When contacting support, please have the following information available:

- Serial number of the unit
- Model number or product name
- Software type and version number.

Zebra responds to calls by email, telephone or fax within the time limits set forth in support agreements.

If your problem cannot be solved by Zebra Customer Support, you may need to return your equipment for servicing and will be given specific directions. Zebra is not responsible for any damages incurred during shipment if the approved shipping container is not used. Shipping the units improperly can possibly void the warranty.

If you purchased your Zebra business product from a Zebra business partner, contact that business partner for support.

Getting Started

Introduction

The DS9308 combines superior 1D and 2D omnidirectional barcode scanning with advanced imaging applications in a compact, easy to use form factor. The DS9308 is designed primarily for hands-free presentation scanning but can easily be picked up and triggered like a hand-held.

Figure 1 DS9308 Scanner



Interfaces



NOTE: Only the Symbol Native API (SNAPI) with Imaging interface supports image capture. See [USB Device Type on page 239](#) to enable this host.

The DS9308 scanner supports:

- USB connection to a host. The scanner autodetects a USB host and defaults to the HID keyboard interface type. Select other USB interface types by scanning programming barcode menus. This interface supports the international keyboards (for Windows® environment) included in the chapter [Country Codes](#).
- Standard RS-232 connection to a host. Scan barcode menus to set up communication of the scanner with the host.
- Connection to IBM 468X/469X hosts. Scan barcode menus to set up communication of the scanner with the IBM terminal.
- Keyboard Wedge connection to a host. The host interprets scanned data as keystrokes. Scan barcode menus to set up communication of the scanner with the host. This interface supports the international keyboards (for Windows® environment) included in the chapter [Country Codes](#).

Unpacking

Remove the scanner from its packing and inspect it for damage. If the scanner was damaged in transit, contact support. See [page 27](#) for contact information. **KEEP THE PACKING.** It is the approved shipping container; use this to return the equipment for servicing.

Features

Figure 2 Parts of the Scanner

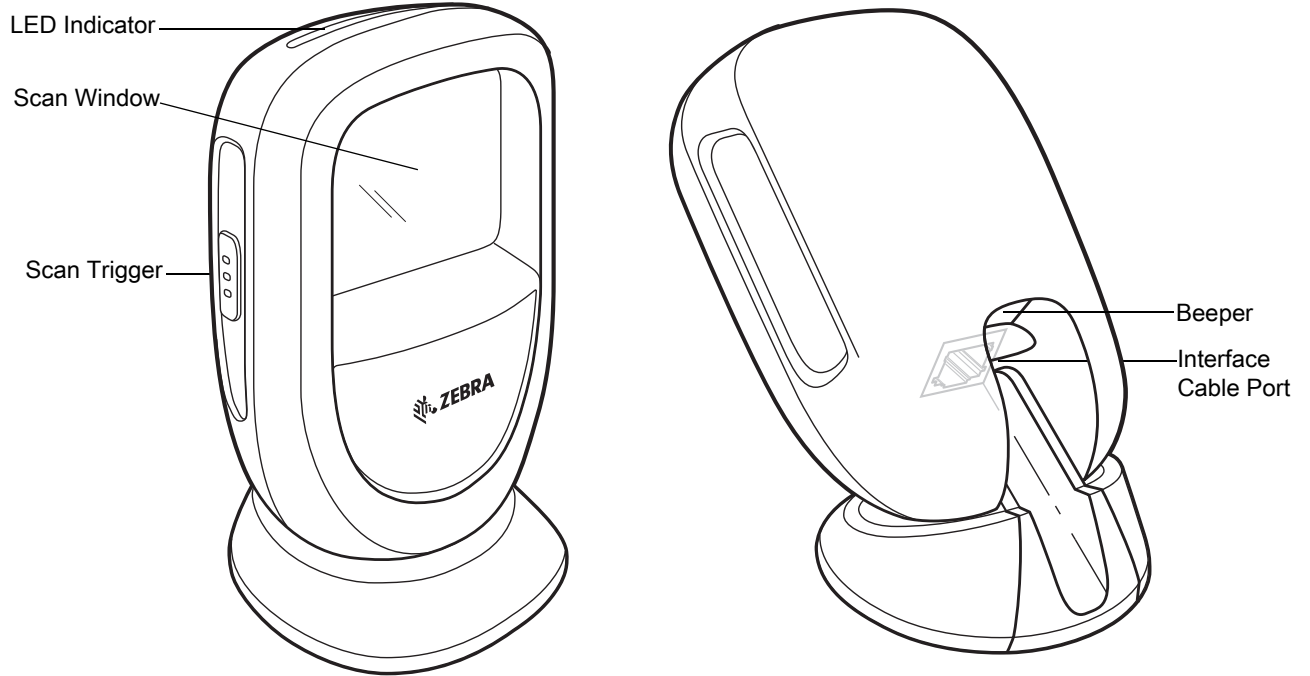

Setting Up the Scanner

Inserting the Interface Cable



NOTE: Different hosts require different cables. The connectors illustrated in each host chapter are examples only. Connectors vary from those illustrated, but the steps to connect the scanner are the same.

1. Place the scanner on a flat surface and tilt the scanner all the way forward.
2. Plug the interface cable modular connector into the cable interface port on the rear of the scanner until you hear a click (see [Figure 3](#)). Gently tug the cable to ensure the connector is secure. The green LED lights and low/medium/high beeps sound, indicating that the scanner is operational.



IMPORTANT: For information about cables and cable compatibility, go to the Zebra Partner Portal at: https://partnerportal.zebra.com/PartnerPortal/product_services/downloads_z/barcode_scanners/Universal-Cable-Guide-Bar-Code-Scanners.xlsx.

Figure 3 Inserting the Cable

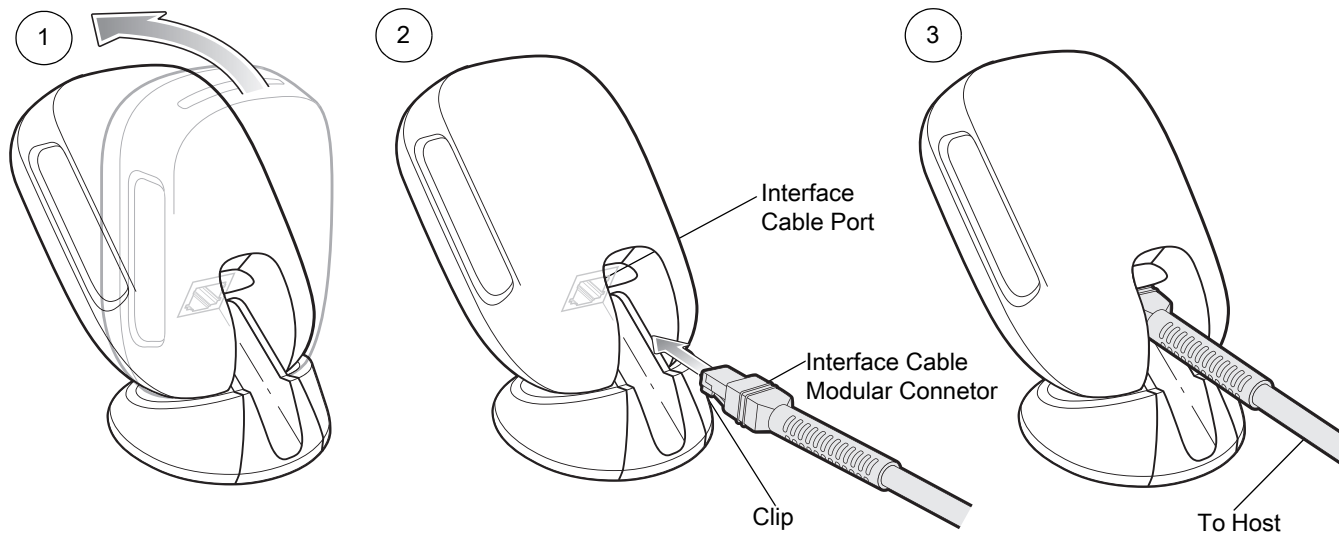

3. Connect the other end of the interface cable to the host (see the specific host chapter for information on host connections).

Removing the Interface Cable

Figure 4 Removing the Cable

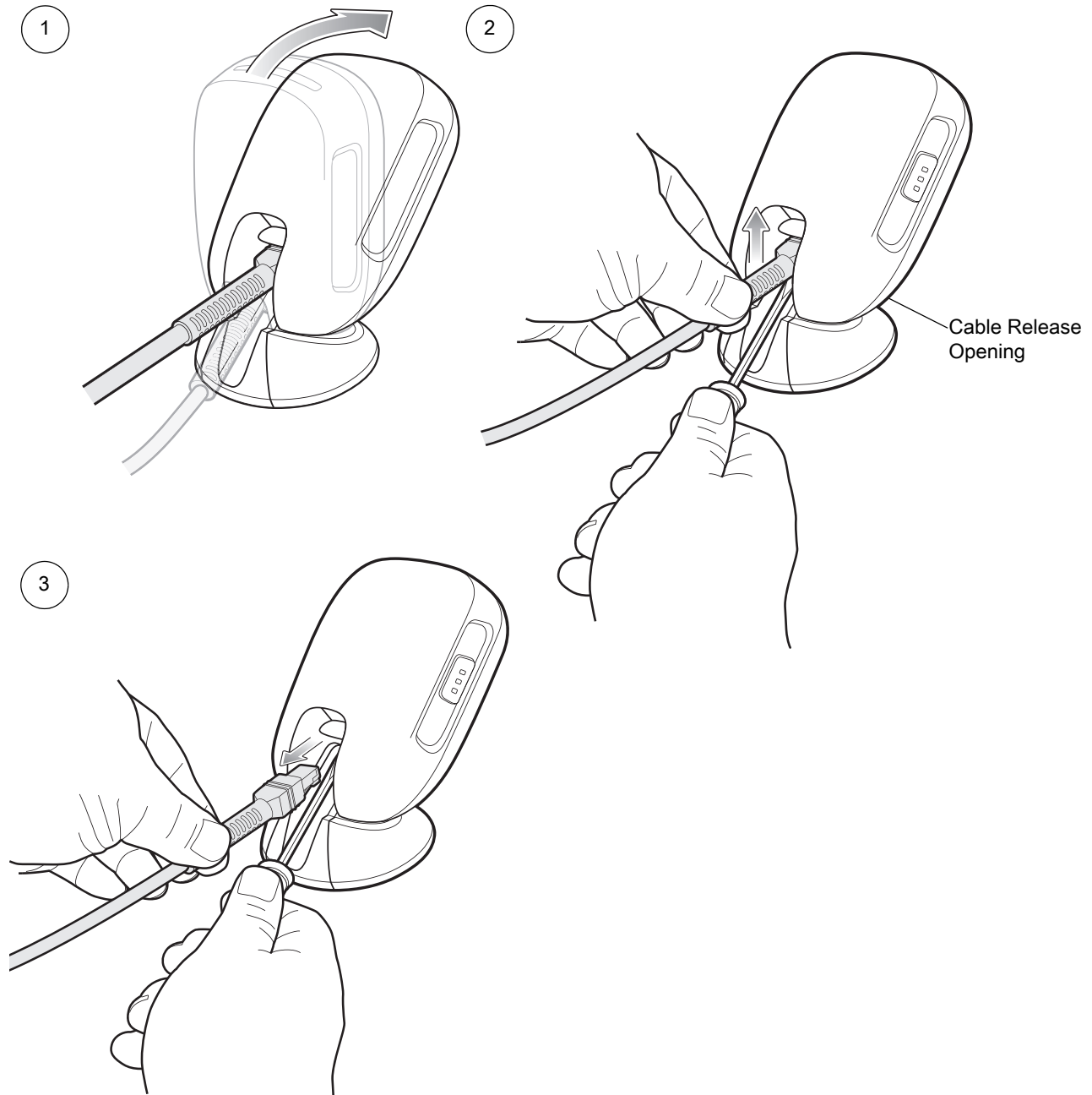

1. Place the scanner on a flat surface and tilt the scanner all the way forward.
2. Insert a small screw driver into the under side of the cable release opening to lift up the cable clip.
3. Pull the cable/connector UP and OUT of the connection and carefully slide out the cable.
4. Follow the steps for [Inserting the Interface Cable](#) to connect a new cable.

Connecting Power (if required)

If the host does not provide power to the scanner, connect an external power supply:

1. Connect the interface cable to the base of the scanner, as described in [Inserting the Interface Cable on page 31](#).
2. Connect the other end of the interface cable to the host (refer to the host manual to locate the correct port).
3. Plug the power supply into the power jack on the interface cable. Plug the other end of the power supply into an AC outlet.

Configuring the Scanner

To configure the scanner use the barcodes included in this manual. See [User Preferences & Miscellaneous Options](#) and [Imager Preferences](#) for information about programming the scanner using barcode menus. Also see each host-specific chapter to set up connection to a specific host type.

Mounting the Scanner

The DS9308 offers the following mounting options:

- Multi-Mount Bracket - Mounts the scanner to a wall (or other vertical surface) or to a table. The device can easily be removed from the multi-mount for hand-held use.
- Locking Table Mount - Mounts to a flat surface and the scanner is locked into place.

Multi-Mount Bracket

The optional multi-mount bracket mounts the scanner to a table top or wall (or other vertical surface). When mounting to a table top, use either screws or the adhesive pad. When mounting to a wall (or other vertical surface) screws are required.



NOTE: When mounting to a table top, screws are more secure than the adhesive pad.

Installing Multi-Mount With Adhesive Pad

Figure 5 Mounting with Adhesive Pad

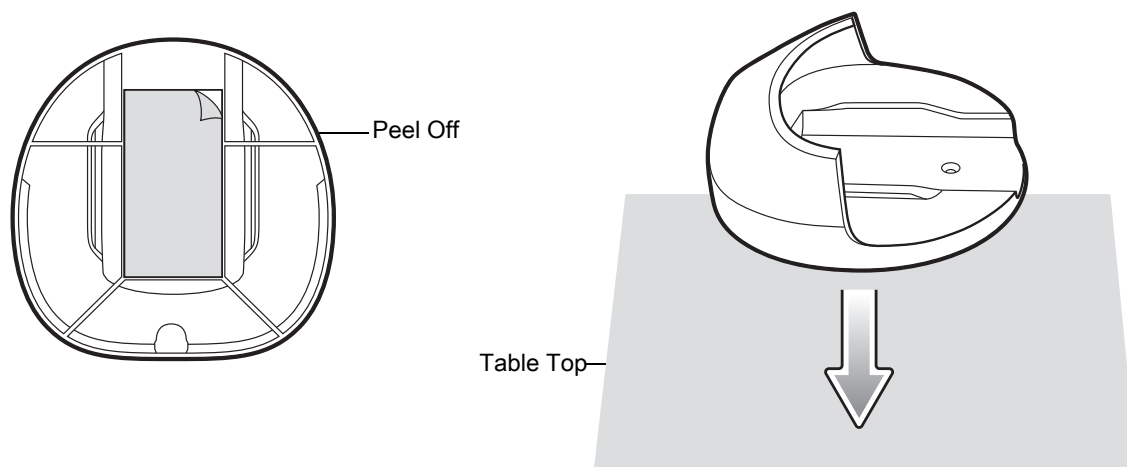

To mount the optional multi-mount bracket using the adhesive pad:

1. Clean the table top surface with Isopropyl alcohol to remove any dirt or debris.
2. Peel the corner of the paper liner off the tape on the bottom of the multi-mount bracket (Figure 5).
3. Press the bottom of the multi-mount bracket on the flat table top and apply uniform pressure for minimally 10 seconds to secure it to the surface (Figure 5).
4. Slide the base of the scanner into the bracket.

Installing Multi-Mount With Screws on Table

To mount the scanner to a table using the optional multi-mount bracket with screws:

1. Place the bracket in the desired location on the table top.
2. Insert two #8 screws through each screw hole in the bracket.

Figure 6 Securing Multi-Mount Bracket to Table

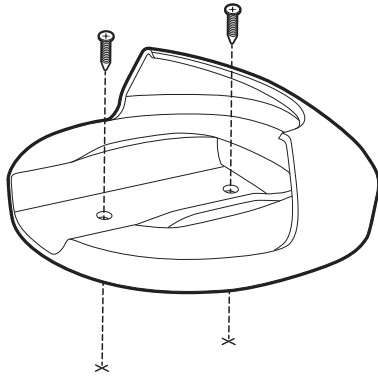

3. Screw into place until secure.

Figure 7 Inserting Scanner into Multi-Mount on Table

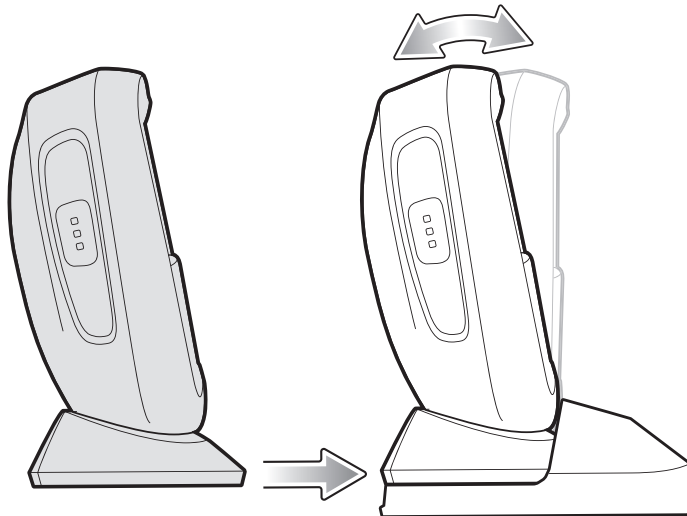

4. Slide the base of the scanner into the bracket.

Installing Multi-Mount with Screws on Wall

To mount the scanner on a wall using the optional multi-mount bracket with screws:

1. Place the bracket in its desired location on the wall and insert two #8 screws through each screw hole in the bracket.

Figure 8 Securing Multi-Mount Bracket to Wall

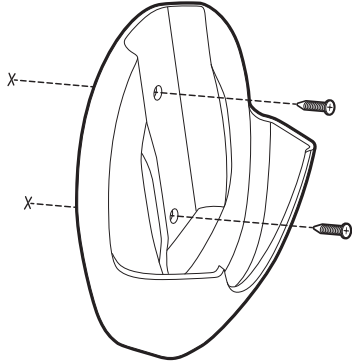

2. Tighten the screws to secure the bracket to the wall.
3. Slide the base of the scanner into the bracket, oriented so the scan window faces down ([Figure 9](#)).

Figure 9 Inserting Scanner into Multi-Mount on Wall

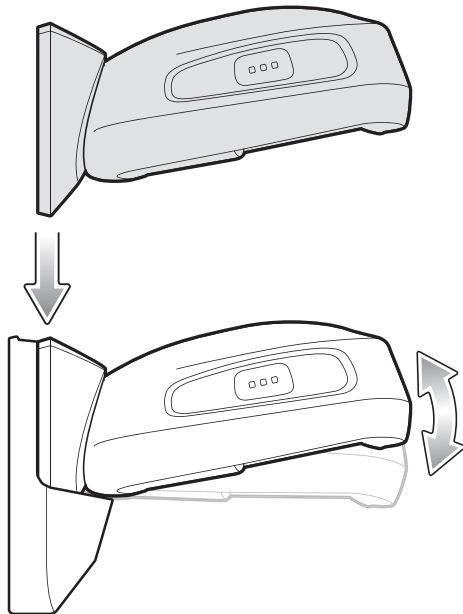

Locking Table Mount

The optional locking table mount is secured to a flat surface and the scanner is locked into place.

Installing Locking Table Mount

To mount the scanner using the optional locking table mount:

1. Place the bracket in the desired location on the table top and insert two #8 screws through each screw hole in the bracket.



NOTE: When selecting the desired location to install the locking table mount bracket, be sure to consider that when the scanner is placed on the mount bracket, it is turned a 1/4 revolution clockwise which will be the final location the scanner faces.

Figure 10 Installing Locking Table Mount Bracket

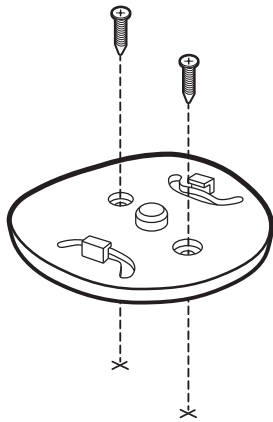

2. Place the scanner onto the bracket.

Figure 11 Inserting Scanner onto Locking Table Mount Bracket

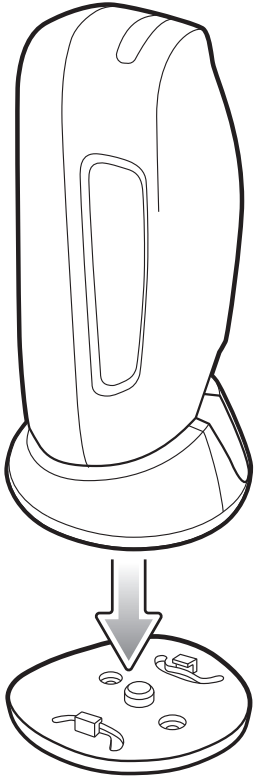

3. Turn the scanner 1/4 revolution clockwise until you hear a click and the scanner faces its final position.

Figure 12 Securing Scanner to Locking Mount Bracket

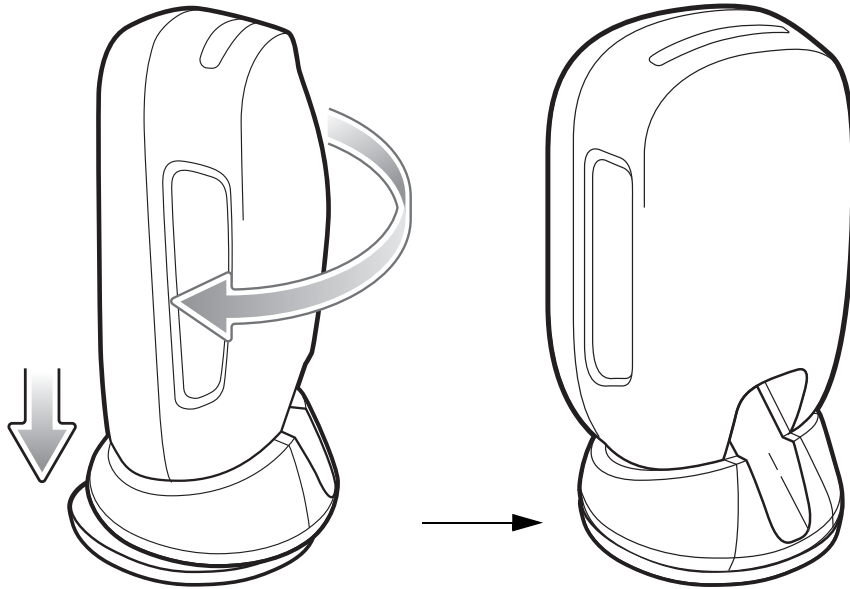

Removing DS9308 from Locking Table Mount

To remove the scanner from the locking table mount, turn counter-clockwise until the scanner is released.

Figure 13 Removing Scanner from Locking Mount Bracket

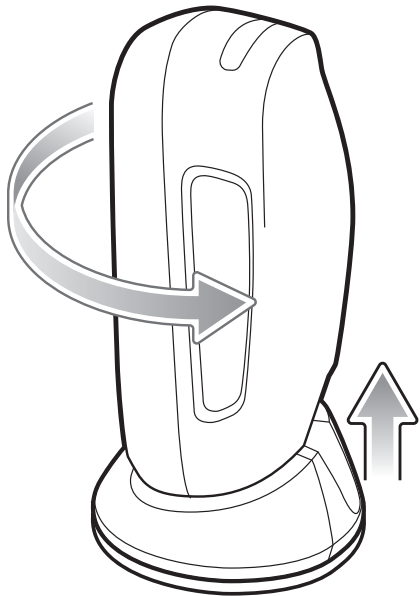

123Scan and Software Tools

Introduction

This chapter briefly describes the Zebra software tools available for customizing scanner operation.

123Scan

123Scan is a software tool that simplifies scanner setup and more.

Intuitive enough for first time users, the 123Scan wizard guides users through a streamlined setup process. Settings are saved in a configuration file that can be printed as a single programming barcode for scanning, emailed to a smart phone for scanning from its screen, or downloaded to the scanner using a USB cable.

Through 123Scan a user can:

- Configure a scanner using a wizard.
 - Program the following scanner settings.
 - Beeper tone / volume settings.
 - Enable / disable symbologies.
 - Communication settings.
 - Modify data before transmission to a host using:
 - Advanced Data Formatting (ADF) - Scan one barcode per trigger pull.
 - Multicode Data Formatting (MDF) - Scan many barcodes in one trigger pull (select scanners).
 - Preferred Symbol - Single out one barcode on label of many (select scanners).
- Load parameter settings to a scanner via the following.
 - Barcode scanning.
 - Scan a paper barcode.
 - Scan a barcode from a PC screen.
 - Scan a barcode from a smart phone screen.
 - Download over a USB cable.
 - Load settings to one scanner.
 - Stage up to 10 scanners simultaneously (Powered USB Hub recommended with 0.5 amp / port).

- Validate scanner setup.
 - View scanned data within the utility's **Data** view screen.
 - Capture an image and save to a PC within the utility's **Data** view screen.
 - Review settings using the Parameter Report.
 - Clone settings from an already deployed scanner from the **Start** screen.
- Upgrade scanner firmware.
 - Load settings to one scanner.
 - Stage up to 10 scanners simultaneously (Powered USB Hub recommended with 0.5 amp / port).
- View statistics such as:
 - Asset tracking information.
 - Time and usage information.
 - Barcodes scanned by symbology.
 - Battery diagnostics (select scanners).
- Generate the following reports.
 - Barcode Report - Programming barcode, included parameter settings, and supported scanner models.
 - Parameter Report - Parameters programmed within a configuration file.
 - Inventory Report - Scanner asset tracking information.
 - Validation Report - Scanned data from the **Data** view.
 - Statistics Report - All statistics retrieved from the scanner.

For more information go to: www.zebra.com/123Scan.

Communication with 123Scan

Use a USB cable to connect the scanner to a Windows host computer running 123Scan.

123Scan Requirements

- Host computer running Windows 7, 8, and 10
- Scanner
- USB cable.

123Scan Information

For more information on 123Scan, go to: www.zebra.com/123Scan.

For a 1 minute tour of 123Scan, go to: www.zebra.com/ScannerHowToVideos.

To see a list of all of our software tools, go to: www.zebra.com/scannersoftware.

Scanner SDK, Other Software Tools, and Videos

Tackle all your scanner programming needs with our diversified set of software tools. Whether you need to simply stage a device, or develop a fully featured application with image and data capture as well as asset management, these tools help you every step of the way.

To download any of the following free tools, go to: www.zebra.com/scannersoftware.

- 123Scan configuration utility
- SDKs
 - Scanner SDK for Windows
 - Scanner SDK for Linux
 - Scanner SDK for Android
- Drivers
 - OPOS driver
 - JPOS driver
 - USB CDC driver
 - TWAIN driver
- Scanner Management Service (SMS) for Remote Management
 - Windows
 - Linux
- How-To-Videos



NOTE: For a list of SDK supported scanner functionality by communication protocol, see [Communication Protocol Functionality](#).

Data Capture

Introduction

This chapter provides beeper and LED definitions, general instructions and tips about scanning, and decode zone diagrams.

Beeper and LED Indicators

In addition to beep sequences, the scanner uses a two-color LED to indicate status.

- The DS9308 scanner includes one LED indicator for system/decode indications.

[Table 3](#) defines beep sequences that occur during both normal scanning and while programming the scanner; LED colors that display during scanning.

Table 3 Scanner Beeper and LED Indications

Beeper Sequence	LED	Indication
Standard Use		
Low/medium/high beeps	Green	Power up.
Medium beep (or as configured)	Hands-free - solid green LED; turns off after decode. Hand-held - LED is off; green upon decode.	A barcode was successfully decoded. (See User Preferences Parameter Defaults on page 60 for programming beeper sounds.)
None	Green (solid)	Presentation (Hands-free) Mode on.
None	No LED (green LED is turned off)	Presentation (Hands-free) Mode off.
Four long low beeps	Red	A transmission error occurred. The data is ignored. This occurs if a unit is not properly configured. Check option setting.
Five long low beeps	Red	Conversion or format error.
None	Red (blinking) on trigger pull	Scanner is disabled by a host command to the scanner.
Image Capture		
Low beep	Green (blinking)	Snapshot mode started.

Table 3 Scanner Beeper and LED Indications (Continued)

Beeper Sequence	LED	Indication
Low beep	Default Green LED based upon hand-held or hands-free mode	Snapshot mode completed.
High/low beeps	Default Green LED based upon hand-held or hands-free mode	Snapshot mode timed-out.
Parameter Programming		
Long low/long high beeps	Red	Input error; incorrect barcode or Cancel scanned, wrong entry, incorrect barcode programming sequence; remain in program mode.
High/low beeps	Green	Number expected. Enter value using numeric barcodes.
High/low/high/low beeps	Green	Successful program exit with change in the parameter setting.
ADF Programming		
Low/high/low beeps	None	ADF transmit error.
High/low beeps	Green	Number expected. Enter another digit. Add leading zeros to the front if necessary.
Low/low beeps	Green	Alphanumeric expected. Enter another alphanumeric character or scan the End of Message barcode.
High/high beeps	Green blinking	ADF criteria or action is expected. Enter another criteria or action or scan the Save Rule barcode.
High/low/low beeps	Green	All criteria or actions cleared for current rule, continue entering rule.
High/low/high/low beeps	Green (turns off after blinking)	Rule saved. Rule entry mode exited.
Long low/long high beeps	Red	Rule error. Entry error, wrong barcode scanned, or criteria/action list is too long for a rule. Re-enter criteria or action.
Low beep	Green	Deleted last saved rule. The current rule is left intact.
Low/high/high beeps	Green	All rules deleted.
Long low/long high/long low/long high beeps	Red	Out of rule memory. Erase some existing rules, then try to save rule again.
Long low/long high/long low beeps	Green (turns off after blinking)	Cancel rule entry. Rule entry mode exited because of an error or the user asked to exit rule entry.
Host Specific		
USB only		
Four high beeps	None	Scanner has not completed initialization. Wait several seconds and scan again.
RS-232 only		
Low/low/low/extra low beeps	Red	RS-232 receive error (parity error).
High beep	None	A <BEL> character is received when Beep on <BEL> is enabled (Point-to-Point mode only).

Table 3 Scanner Beeper and LED Indications (Continued)

Beeper Sequence	LED	Indication
123Scan only (When in use, the utility controls the scanner LED)		
None	Green (slow blinking)	Scanner connected to 123Scan.
None	Red (fast blinking)	File being transferred to the scanner (parameters and firmware).
None	Red (slow blinking)	Firmware being activated on the scanner, loaded into memory.
None	Green (solid)	Programming completed successfully (parameters and firmware).
None	Red (solid)	Error state.
SMS only		
None	Red (blinking)	Loading the SMS package to scanner.
Maintenance Indications		
High/high beeps	Red (stays on)	Enter Bootloader.
None	Red (blinking)	Firmware installation.
Macro PDF		
Low/low beeps	None	Buffered File ID error. A barcode not in the current MPDF sequence was scanned.
Long low/long low beeps (2 long low beeps)	None	File ID error. A barcode not in the current MPDF sequence was scanned.
Long low/long low/long low beeps (3 long low beeps)	None	Out of memory. There is not enough buffer space to store the current MPDF symbol.
Long low/long low/long low/long low beeps (4 long low beeps)	None	Bad symbology. Scanned a 1D or 2D barcode in an MPDF sequence, a duplicate MPDF label, a label in an incorrect order, or trying to transmit an empty or illegal MPDF field.
Long low/long low/long low/long low/long low beeps (5 long low beeps)	None	Flushing MPDF buffer.
Fast Warble	None	Aborting MPDF sequence.
Low/high beeps	None	Flushing an already empty MPDF buffer.

Scanning

The DS9308 has a built-in, adjustable base to easily accommodate both hands-free (presentation) and hand-held scanning.

Hands-free Scanning

The scanner is in hands-free (presentation) mode when it sits on a counter top, or when it is mounted on a wall using the multi-mount bracket. In this mode, the scanner operates in continuous (constant-on) mode, where it automatically decodes a barcode presented in its field of view.

In hands-free mode the LED indicator turns solid green. An aiming dot does not appear.

Figure 14 Scanning in Hands-free Mode

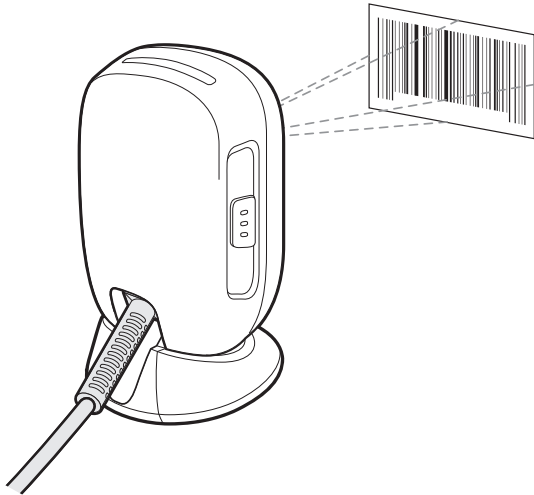

Hand-held Scanning

To operate the digital scanner in hand-held mode (momentary trigger mode):

1. Pick up the digital scanner and press the trigger. The aiming dot displays.

Figure 15 Scanning in Hand-held (Momentary Trigger) Mode

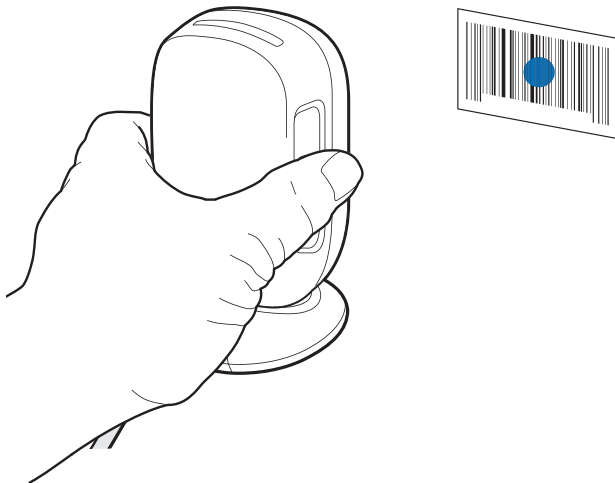

2. Ensure the aiming dot is centered on the barcode (see [Figure 17](#)).

3. Press and hold the trigger until either:
 - a. The digital scanner reads the barcode. The digital scanner beeps and the successful decode LED flashes.
 - b. The digital scanner does not read the barcode and the illumination turns off.
4. Release the trigger. The aiming dot reappears. To read another barcode, repeat steps 2 and 3.

After a programmable time period (see [Momentary Trigger Mode Timeout on page 77](#)), the aiming dot turns off and the digital scanner returns to presentation mode, ready to read barcodes without the use of the trigger. For beeper definitions, see [Table 3 on page 42](#).

Aiming

The scanner may project an LED dot which allows positioning the barcode within its field of view. See [Decode Ranges on page 47](#) for the proper distance to achieve between the scanner and a barcode.

Figure 16 Scanning Orientation with Imager Aiming Dot

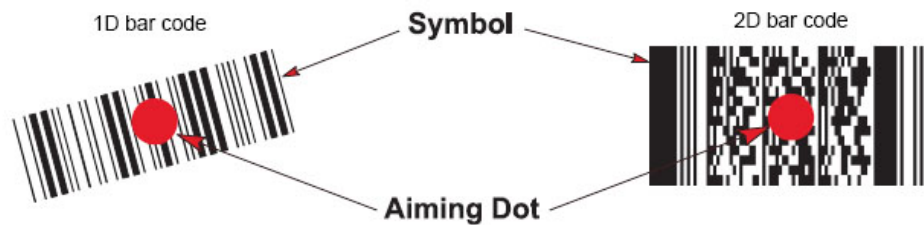

The scanner can also read a barcode presented within the aiming dot not centered. The top examples in [Figure 17](#) show acceptable aiming options, while the bottom examples can not be decoded.

Figure 17 Acceptable and Incorrect Aiming

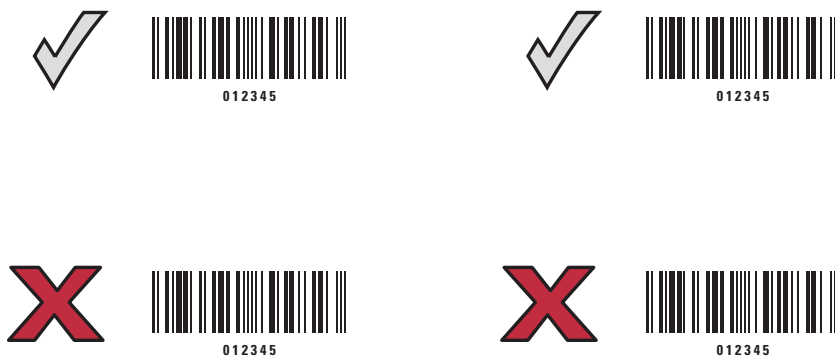

The aiming dot is smaller when the scanner is closer to the symbol and larger when it is farther from the symbol. Scan symbols with smaller bars or elements (mil size) closer to the scanner, and those with larger bars or elements (mil size) farther from the scanner.

The scanner beeps to indicate that it successfully decoded the barcode. For more information on beeper and LED definitions, see [Table 3 on page 42](#).

Decode Ranges

Table 4 DS9308 Decode Ranges

Symbol Density	Barcode Type	Working Ranges	
		Near	Far
3.0 mil	Code 39	0 in. / 0 cm	2.5 in. / 6.35 cm
4.0 mil	Code 39	0 in. / 0 cm	4.0 in. / 10.2 cm
5.0 mil	Code 39	0 in. / 0 cm	5.0 in. / 12.7 cm
7.5 mil	Code 39	0 in. / 0 cm	6.5 in. / 16.5 cm
20 mil	Code 39	0 in. / 0 cm	11.0 in. / 27.9 cm
3 mil	Code 128	0 in. / 0 cm	2.0 in. / 5.1 cm
5 mil	Code 128	0 in. / 0 cm	4.0 in. / 10.2 cm
13 mil (100%)	UPC	0 in. / 0 cm	8.8 in. / 22.4 cm
10 mil	Data Matrix	0 in. / 0 cm	4.5 in. / 11.4 cm
20 mil	QR	0 in. / 0 cm	7.5 in. / 19.1 cm

Electronic Article Surveillance (EAS)



NOTE: EAS is available only on scanner models that support Checkpoint EAS.

Some scanner configurations include an integrated Electronic Article Surveillance (EAS) antenna.

The scanner's integrated EAS deactivation antenna requires an EAS host cable. This Y-cable connects to the scanner's host port at one end, and splits to the host and the EAS system at the other end.

Installing

Checkpoint EAS Model Compatibility

The scanner is intended for use with Checkpoint CP-VII, CP-IX, and CP-XI systems. It does not support CP-IV and other low-power receiver-based EAS deactivation systems.

Considerations

The Checkpoint CP-VII system generates a periodic burst of electromagnetic energy that deactivates EAS tags brought near the scanner. To avoid interference with the scanner's operation, take the following precautions when installing the EAS system:

- Position the EAS antenna box as far as possible from the scanner (at least 6 in. / 15.24 cm.)
- Position the EAS antenna, EAS antenna box, EAS control cable, and EAS controller box as far as possible from the scanner's host and power cables.

EAS range is as dependent on the Checkpoint system (which is calibrated onsite) as it is on the scanner. Therefore, we cannot provide estimated ranges, however these are some of the factors that contribute to EAS range:

- Antenna – Length, gauge, number of turns, placement in the scanner.
- Type of Checkpoint EAS system used (ie. CP-VII, CP-IX, and CP-XI).
- Length of wire connecting antenna to (Checkpoint) EAS (site/installation dependent)
- Settings done within Checkpoint system (site/installation dependent).

Checkpoint Contact Information

Contact your local Checkpoint representative to install the EAS cable to the Checkpoint Deactivation System.

Maintenance, Troubleshooting, and Technical Specifications

Introduction

This chapter provides suggested scanner maintenance, troubleshooting, technical specifications, and signal descriptions (pinouts).

Maintenance

Known Harmful Ingredients

The following chemicals are known to damage the plastics on Zebra scanners and should not come in contact with the device:

- Acetone
- Ammonia solutions
- Aqueous or alcoholic alkaline solutions
- Aromatic and chlorinated hydrocarbons
- Benzene
- Carboic acid
- Compounds of amines or ammonia
- Ethanolamine
- Ethers
- Ketones
- TB-lysoform
- Toluene
- Trichloroethylene.

Approved Cleaners for the Scanner

- Isopropyl alcohol 70% (including pre-moistened wipes).

Cleaning the Scanner

Routinely cleaning the exit window is required. A dirty window may affect scanning accuracy. Do not allow any abrasive material to touch the window.

To clean the scanner:

1. Dampen a soft cloth with one of the approved cleaning agents listed above or use pre-moistened wipes.
2. Gently wipe all surfaces, including the front, back, sides, top and bottom. Never apply liquid directly to the scanner. Be careful not to let liquid pool around the scanner window, trigger, cable connector or any other area on the device.
3. Be sure to clean the trigger and in between the trigger and the housing (use a cotton-tipped applicator to reach tight or inaccessible areas).
4. Do not spray water or other cleaning liquids directly into the exit window.
5. Wipe the scanner exit window with a lens tissue or other material suitable for cleaning optical material such as eyeglasses.
6. Immediately dry the scanner window after cleaning with a soft non-abrasive cloth to prevent streaking.
7. Allow the unit to air dry before use.
8. Scanner connectors:
 - a. Dip the cotton portion of a cotton-tipped applicator in isopropyl alcohol.
 - b. Rub the cotton portion of the cotton-tipped applicator back-and-forth across the connector on the Zebra scanner at least 3 times. Do not leave any cotton residue on the connector.
 - c. Use the cotton-tipped applicator dipped in alcohol to remove any grease and dirt near the connector area.
 - d. Use a dry cotton tipped applicator and rub the cotton portion of the cotton-tipped applicator back-and-forth across the connectors at least 3 times. Do not leave any cotton residue on the connectors.

Troubleshooting



NOTE: If after performing the possible solutions in [Table 5](#) the scanner still experiences problems, contact the distributor or call support.

Table 5 Troubleshooting

Problem	Possible Causes	Possible Solutions
The illumination does not appear when pressing the trigger.	No power to the scanner.	If the configuration requires a power supply, re-connect the power supply.
	Incorrect host interface cable is used.	Connect the correct host interface cable.
	Interface/power cables are loose.	Re-connect cables.
	Scanner is disabled.	For IBM 468x and USB IBM hand-held, IBM table-top, and OPOS modes, enable the scanner via the host interface. Otherwise, see the technical person in charge of scanning.
	If using RS-232 Nixdorf B mode, CTS is not asserted.	Assert CTS line.
	Illumination is disabled.	Enable the illumination. See Decoding Illumination on page 84 .
Scanner emits illumination, but does not decode the barcode.	Scanner is not programmed for the correct barcode type.	Program the scanner to read that type of barcode. See Symbologies .
	Barcode symbol is unreadable.	Scan test symbols of the same barcode type to determine if the barcode is defaced.
	The symbol is not completely inside illumination.	Move the symbol completely within the illumination. Move the symbol completely within the field of view (AIM pattern does NOT define FOV)
	Distance between scanner and barcode is incorrect.	Move the scanner closer to or further from the barcode. See Decode Ranges on page 47 .

Table 5 Troubleshooting (Continued)

Problem	Possible Causes	Possible Solutions
Scanner decodes barcode, but does not transmit the data to the host.	Scanner is not programmed for the correct host type.	Scan the appropriate host type programming barcode. See the chapter corresponding to the host type.
	Interface cable is loose.	Re-connect the cable.
	If the scanner emits four long low beeps, a transmission error occurred. This occurs if a unit is not properly configured or connected to the wrong host type.	Set the scanner's communication parameters to match the host's setting.
	If the scanner emits 5 low beeps, a conversion or format error occurred.	Configure the scanner's conversion parameters properly.
	If the scanner emits low/high/low beeps, it detected an invalid ADF rule.	Program the correct ADF rules. Refer to the Advanced Data Formatting Programmer Guide.
Host displays scanned data incorrectly.	Scanner is not programmed to work with the host.	Scan the appropriate host type programming barcode.
		For RS-232, set the scanner's communication parameters to match the host's settings.
		For a Keyboard Wedge configuration, program the system for the correct keyboard type, and turn off the CAPS LOCK key.
		Program the proper editing options (e.g., UPC-E to UPC-A Conversion).
Scanner emits short low/short medium/short high beep sequence (power-up beep sequence) more than once.	The USB bus may put the scanner in a state where power to the scanner is cycled on and off more than once.	Normal during host reset.
Scanner emits 4 short high beeps during decode attempt.	Scanner has not completed USB initialization.	Wait several seconds and scan again.
Scanner emits Low/low/low/extra low beeps when not in use.	RS-232 receive error.	Normal during host reset. Otherwise, set the scanner's RS-232 parity to match the host setting.
Scanner emits low/high beeps during programming.	Input error, incorrect barcode or Cancel barcode was scanned.	Scan the correct numeric barcodes within range for the parameter programmed.

Table 5 Troubleshooting (Continued)

Problem	Possible Causes	Possible Solutions
Scanner emits low/high/low/high beeps during programming.	Out of host parameter storage space.	Scan Default Parameters on page 62 .
	Out of memory for ADF rules.	Reduce the number of ADF rules or the number of steps in the ADF rules.
	During programming, indicates out of ADF parameter storage space.	Erase all rules and re-program with shorter rules.
Scanner emits low/high/low beeps.	ADF transmit error.	Refer to the Advanced Data Formatting Guide for information.
	Invalid ADF rule is detected.	Refer to the Advanced Data Formatting Guide for information.
Scanner emits a power-up beep after changing USB host type.	The USB bus re-established power to the scanner.	Normal when changing USB host type.
Scanner emits one high beep when not in use.	In RS-232 mode, a <BEL> character was received and Beep on <BEL> option is enabled.	Normal when Beep on <BEL> is enabled and the scanner is in RS-232 mode.
Scanner emits frequent beeps.	Inadequate power supplied to the scanner.	Check the system power. If the configuration requires a power supply, re-connect the power supply.
	Incorrect host interface cable is used.	Verify that the correct host interface cable is used. If not, connect the correct host interface cable.
	Interface/power cables are loose.	Check for loose cable connections and re-connect cables.
Scanner emits five long low beeps after a barcode is decoded.	Conversion or format error was detected. The scanner conversion parameters are not properly configured.	Ensure the scanner conversion parameters are properly configured.
	Conversion or format error was detected. An ADF rule was set up with characters that can't be sent for the host selected.	Change the ADF rule, or change to a host that can support the ADF rule.
	Conversion or format error was detected. A barcode was scanned with characters that can't be sent for that host.	Change the barcode, or change to a host that can support the barcode.

Report Product Information

Report Software Version

Scan the following barcode to send the version of software installed in the scanner.

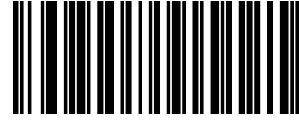

Report Software Version

Report Serial Number

Scan the following barcode to send the scanner serial number to the host.

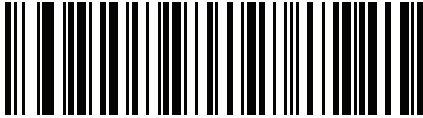

Serial Number

Report Manufacturing Information

Scan the following barcode to send the scanner manufacturing information to the host.

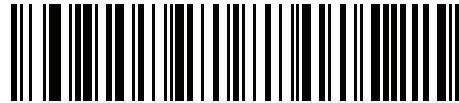

Manufacturing Information

Technical Specifications

Table 6 Technical Specifications

Item	Description			
Physical Characteristics				
Dimensions	5.7 in H x 3.4 in W x 3.3 in D 14.5 cm H x 8.6 cm W x 8.3 cm D			
Weight	11.2 oz (318 g)			
Available Colors	Midnight Black, Alpine White			
Supported Host Interfaces	USB, RS232, Keyboard Wedge, TGCS (IBM) 46XX over RS485			
USB Certification	DS9308 is USB2.0 Full Speed Compliant, visit USB.org for more details.			
Keyboard Support	Supports over 90 international keyboards			
Electronic Article Surveillance	Compatible with Checkpoint deactivation system			
Electrical Characteristics				
	SR and DL Models			
	Minimum		Maximum	Unit
Supply Voltage	4.5	5.0	5.5	V
Idle current (Hand-held)		75		mA
Idle current (Hands-free)		135		mA
Scanning current (Hand-held)		350		mA
Scanning current (Hands-free)		335		mA
Performance Characteristics				
Swipe Speed	Up to 120 in./305 cm per second for 13 mil UPC in optimized mode			
Aiming Dot	Amber 617nm LED			
Illumination	Red 660nm LED			
Field of View (Horizontal x Vertical) Nominal	52° H x 33° V			

Table 6 Technical Specifications (Continued)

Item	Description
Image Sensor	1280 x 800 pixels
Minimum Print Contrast	15% minimum reflective difference
Skew Tolerance	+/- 60°
Pitch Tolerance	+/- 60°
Roll Tolerance	360°
Image Capture	
Graphics Format Support	Images can be exported as Bitmap, JPEG, or TIFF
Resolution (4 x 5.8 in. document @ 6 in.)	109 PPI
User Environment	
Operating Temperature	32° F to 122° F (0° C to 50° C)
Storage Temperature	-40° to 158°F / -40° to 70°C
Humidity	5% to 95% RH, non-condensing
Drop Specifications	Designed to withstand multiple drops at 5.0 ft/1.5 m to concrete
Tumble Specification (Scanner)	Designed to withstand 1,000 tumbles in 1.5 ft./0.5 m tumbler
Ambient Light Immunity	0 to 10,000 Foot Candles/0 to 107,700 Lux
Environmental Sealing	IP52
Electrostatic Discharge (ESD)	ESD per EN61000-4-2, +/-15 KV Air, +/-8 KV Indirect
Accessories (see page 24)	
Symbol Decode Capability	
1D	Code 39, Code 128, Code 93, Codabar/NW7, Code 11, MSI Plessey, UPC/EAN, I 2 of 5, Korean 3 of 5, GS1 DataBar, Base 32 (Italian Pharma)
2D	PDF417, Micro PDF417, Composite Codes, TLC-39, Aztec, Data Matrix, MaxiCode, QR Code, Micro QR, Han Xin, Postal Codes, SecurPharm, Dotcode, Dotted Datamatrix
Digimarc	Digital watermark technology; available on specific models only
OCR	OCR-A, OCR-B, MICR, US Currency
Minimum Element Resolution	Code 39 3 mil Code 128 3 mil QR Code 5 mil Data Matrix 5 mil See Decode Ranges on page 47 for working ranges.
Regulatory	

Table 6 Technical Specifications (Continued)

Item	Description
Environmental: Restriction of Hazardous Substances (RoHS)	EN 50581 EN IEC 63000
EMC	EN 55032, EN55024, EN55035 EN 61000-3-2, EN 61000-3-3 47 CFR Part 15, Subpart B, Class B, ICES-003, Class B
Health and Safety	IEC 62368-1, UL 62368-1, CAN/CSA-22.2 N0. 62368-1-14 IEC 62471
Utilities and Management	
123Scan	Programs scanner parameters, upgrades firmware, provides scanned barcode data and prints reports. See 123Scan and Software Tools . www.zebra.com/123Scan
Symbol Scanner SDK	Generates a fully-featured scanner application, including documentation, drivers, test utilities and sample source code. www.zebra.com/ScannerSDKforWindows
Scanner Management Service (SMS)	Remotely manages your Zebra scanner and queries its asset information. www.zebra.com/sms

Scanner Signal Descriptions

Figure 18 Scanner Cable Pinouts

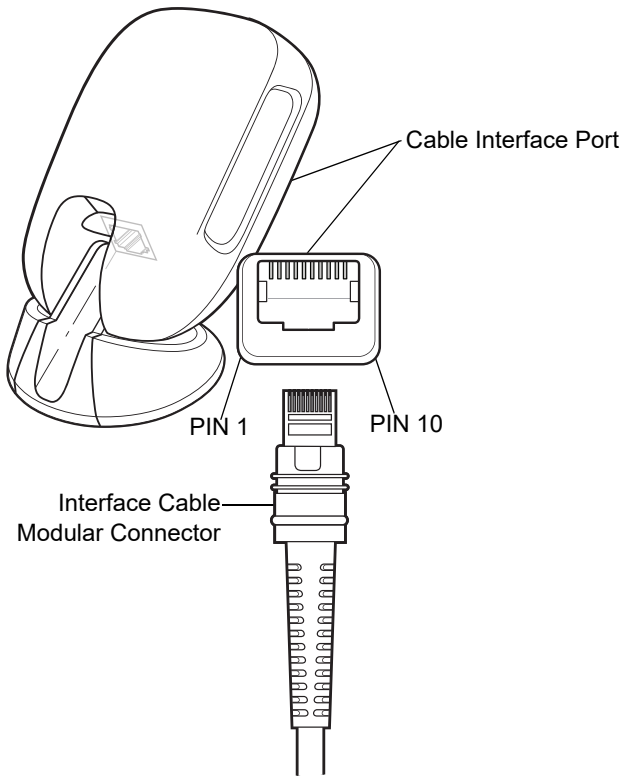

The signal descriptions in [Table 7](#) apply to the connectors on the DS9308 scanner and are for reference only.

Table 7 DS9308 Scanner Signal Pin-outs

Pin	IBM	RS-232	Keyboard Wedge	USB
1	Cable ID	Cable ID	Cable ID	Cable ID
2	Power (+5V)	Power (+5V)	Power (+5V)	Power (+5V)
3	Ground	Ground	Ground	Ground
4	IBM_OUT	TxD	KeyClock	Reserved
5	IBM_IN	RxD	TermData	D +
6	IBM_T/R	RTS	KeyData	Reserved
7	Reserved	CTS	TermClock	D -
8	Reserved	Reserved	Reserved	Reserved
9	See note			
10	See note			

Note: EAS configurations use pins 9 and 10 for an EAS antenna. For other configurations pins 9 and 10 are open.

User Preferences & Miscellaneous Options

Introduction

You can program the scanner to perform various functions, or activate different features. This chapter describes user preference features and provides programming barcodes for selecting these features.

The scanner ships with the settings shown in [Table 8 on page 60](#) (also see [Parameter Defaults](#) for all defaults). If the default values suit requirements, programming is not necessary.

Setting Parameters

To set feature values, scan a single barcode or a short barcode sequence. The settings are stored in non-volatile memory and are preserved even when the scanner powers down.



NOTE: Most computer monitors allow scanning barcodes directly on the screen. When scanning from the screen, be sure to set the document magnification to a level where you can see the barcode clearly, and bars and/or spaces do not merge.

If not using the default host, select the host type (see each host chapter for specific host information) after the power-up beeps sound. This is only necessary upon the first power-up when connected to a new host.

To return all features to default values, see [Default Parameters on page 62](#). Throughout the programming barcode menus, asterisks indicate (*) default values.

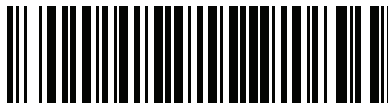

* Indicates default * Enable Parameter (1) Feature/option
Option value

Scanning Sequence Examples

In most cases, scanning one barcode sets the parameter value. For example, to set the beeper tone to high, scan the **High Frequency** (beep tone) barcode listed under [Beep Tone on page 65](#). The scanner issues a fast warble beep and the LED turns green, signifying a successful parameter entry.

Other parameters require scanning several barcodes. See the parameter descriptions for this procedure.

Errors While Scanning

Unless otherwise specified, to correct an error during a scanning sequence, just re-scan the correct parameter.

User Preferences/Miscellaneous Options Parameter Defaults

Table 8 lists defaults for user preferences parameters. Change these values in one of two ways:

- Scan the appropriate barcodes in this chapter. The new value replaces the standard default value in memory. To recall default parameter values, see [Default Parameters on page 62](#).
- Configure the scanner using the 123Scan configuration program. See [123Scan and Software Tools](#).



NOTE: See [Parameter Defaults](#) for all user preference, host, symbology, and miscellaneous default parameters.

Table 8 User Preferences Parameter Defaults

Parameter	Parameter Number ¹	SSI Number ²	Default	Page Number
Standard User Preferences				
Set Default Parameter	N/A	N/A	N/A	62
Parameter Barcode Scanning	236	ECh	Enable	63
Beep After Good Decode	56	38h	Enable	63
Beep Volume	140	8Ch	High	64
Beep Tone	145	91h	Medium	65
Beep Duration	628	F1h 74h	Short	67
Volume Adjustment Trigger Timeout	403	F0h 93h	5 Seconds	68
Suppress Power Up Beeps	721	F1h D1h	Do Not Suppress	69
Direct Decode Indicator	859	F2h 5Bh	Disable	70
Low Power Mode	128	80h	Disable	71
Time Delay to Low Power Mode	146	92h	1 Hour	72
Trigger Mode	138	8Ah	Presentation Mode	74
Hand-held Decode Aiming Pattern	306	F0h 32h	Enable	75
Presentation (Hands-free) Decode Aiming Pattern	590	F1h 4Eh	Disable Presentation (Hands-free) Decode Aiming Pattern	76
Momentary Trigger Mode Timeout	2030	EDh	5 Seconds	77
1. Parameter number decimal values are used for programming via RSM commands. 2. SSI number hex values are used for programming via SSI commands.				

Table 8 User Preferences Parameter Defaults (Continued)

Parameter	Parameter Number ¹	SSI Number ²	Default	Page Number
Picklist Mode	402	F0h 92h	Enable Picklist Mode in Hand-held Mode	78
Continuous Barcode Read	649	F1h 89h	Disable	79
Unique Barcode Reporting	723	F1h D3h	Enable	79
Decode Session Timeout	136	88h	9.9 Seconds	80
Timeout Between Decodes, Same Symbol	137	89h	0.5 Seconds	80
Timeout Between Decodes, Different Symbols	144	90h	0.1 Seconds	81
Triggered Timeout, Same Symbol	724	F1h D4h	Disable	81
Mobile Phone/Display Mode	716	F1h CCh	Normal	82
PDF Prioritization	719	F1h CFh	Disable	83
PDF Prioritization Timeout	720	F1h D0h	200 ms	83
Decoding Illumination	298	F0h 2Ah	Enable	84
Illumination Brightness	669	F1h 9Dh	High	85
Motion Tolerance (Hand-held Trigger Mode Only)	858	F2h 5Ah	Less Motion Tolerance	86
Product ID (PID) Type	1281	F8h 05h 01h	Host Type Unique	86
Product ID (PID) Value	1725	F8h 06h BDh	0	87
ECLevel	1710	F8h 06h AEh	0	87
Miscellaneous Options				
Enter Key	N/A	N/A	N/A	88
Tab Key	N/A	N/A	N/A	88
Transmit Code ID Character	45	2Dh	None	89
Prefix Value	99, 105	63h, 69h	7013 <CR><LF>	90
Suffix 1 Value Suffix 2 Value	98, 104 100, 106	62h, 68h 64h, 6Ah	7013 <CR><LF>	90
Scan Data Transmission Format	235	EBh	Data As Is	91
FN1 Substitution Values	103, 109	67h, 6Dh	7013 <CR><LF>	93
Transmit "No Read" Message	94	5E	Disable	94
Unsolicited Heartbeat Interval	1118	F8h 04h 5Eh	Disable	95

1. Parameter number decimal values are used for programming via RSM commands.

2. SSI number hex values are used for programming via SSI commands.

Table 8 User Preferences Parameter Defaults (Continued)

Parameter	Parameter Number ¹	SSI Number ²	Default	Page Number
securPharm Decoding	1752	F8h 06h D8h	Disable	96
securPharm Output Formatting	1753	F8h 06h D9h	No Formatting	97

1. Parameter number decimal values are used for programming via RSM commands.
 2. SSI number hex values are used for programming via SSI commands.

Standard User Preferences

Default Parameters

Scan one of the following barcodes to reset the scanner to its default settings as follows:

- **Restore Defaults** resets all default parameters as follows:
 - If you configured custom default parameter values via the **Write to Custom Defaults** barcode, scanning the **Restore Defaults** barcode restores these custom values.
 - If you did not configure custom default parameter values, scanning the **Restore Defaults** barcode restores the factory default values. See [Parameter Defaults](#) for these values.
- **Set Factory Defaults** clears all custom default values and sets the factory default values. See [Parameter Defaults](#) for these values.

Write to Custom Defaults

To create a set of custom defaults, select the desired parameter values in this guide, and then scan **Write to Custom Defaults**.



Restore Defaults



Set Factory Defaults



Write to Custom Defaults

Parameter Barcode Scanning

Parameter # 236

SSI # ECh

Scan one of the following barcodes to select whether to enable or disable the decoding of parameter barcodes, including the **Set Defaults** barcodes.



* **Enable Parameter Barcode Scanning**
(1)



Disable Parameter Barcode Scanning
(0)

Beep After Good Decode

Parameter # 56

SSI # 38h

Scan one of the following barcodes to select whether or not the scanner beeps after a good decode. If you select **Do Not Beep After Good Decode**, the beeper still operates during parameter menu scanning and to indicate error conditions.



* **Enable Beep After Good Decode**
(1)



Disable Beep After Good Decode
(0)

Beep Volume

Parameter # 140

SSI # 8Ch

Scan one of the following barcodes to select a beep volume.



Low Volume
(2)



Medium Volume
(1)



*** High Volume**
(0)

Beep Tone

Parameter # 145

SSI # 91h

Scan one of the following barcodes to select a beep tone for audible feedback indicating a good decode. Select from the [Standard Beep Tones](#) below or from the [Beep Duration on page 67](#).

Scan [Disable Beep Tone](#) to disable all tones.



Disable Beep Tone
(3)

Standard Beep Tones



Low Beep Tone
(2)

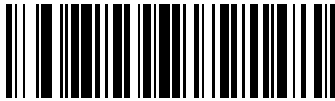

*** Medium Beep Tone**
(1)



High Beep Tone
(0)



Medium to High Beep Tone (2-tone)
(4)

Special Tones



Wood Block / Tone 1
(6)



Pulse / Tone 2
(7)



Chime / Tone 3
(8)



Zap / Tone 4
(9)

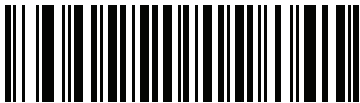

Triple Beep / Tone 5
(10)



User Programmable / Tone 6
(11)

Note: See [Custom Tone](#) to download a custom tone.

Beep Duration

Parameter # 628

SSI # F1h 74h

Scan one of the following barcodes to select the duration for the good decode beep.



* Short Duration
(0)



Medium Duration
(1)



Long Duration
(2)

Volume Adjustment Trigger Timeout

Parameter # 403

SSI # F0h 93h

Scan one of the following barcodes to set the length of time needed to hold the trigger to adjust the volume. The scanner changes volume and beeps with the new volume.

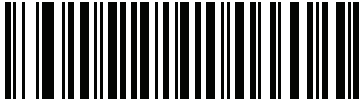

3 Seconds
(30)



*** 5 Seconds**
(50)

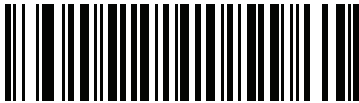

7 Seconds
(70)



10 Seconds
(100)

Suppress Power Up Beeps

Parameter # 721

SSI # F1h D1h

Scan one of the following barcodes to select whether or not to suppress the scanner's power-up beeps.



* Do Not Suppress Power Up Beeps
(0)



Suppress Power Up Beeps
(1)

Direct Decode Indicator

Parameter # 859

SSI # F2h 5Bh

This parameter is only supported in Standard (Level) [Trigger Mode](#). Scan one of the following barcodes to select optional blinking of the illumination on a successful decode if you continue to hold the trigger. If you release the trigger upon decode, the blinking does not occur. This allows you to choose additional feedback for a successful decode by holding the trigger, or to continue to scan as normal.

- * **Disable Direct Decode Indicator** - Illumination does not blink on a successful decode.
- **1 Blink** - Illumination blinks once upon a successful decode.
- **2 Blinks** - Illumination blinks twice upon a successful decode.



* **Disable Direct Decode Indicator**
(0)



1 Blink
(1)



2 Blinks
(2)

Low Power Mode

Parameter # 128

SSI # 80h



NOTE: The Low Power Mode parameter only applies for non-USB and non-RS485 host interfaces, and when [Trigger Mode](#) is set to **Level (Standard)**.

Scan one of the following barcodes to select whether or not the scanner enters low power mode after a decode attempt or host communication. This applies to serial and keyboard wedge connections. If disabled, power remains on after each decode attempt.

If you enable this, see [Time Delay to Low Power Mode](#) to set the inactivity time period.



**Enable Low Power Mode
(1)**



*** Disable Low Power Mode
(0)**

Time Delay to Low Power Mode

Parameter # 146

SSI # 92h



NOTE: This parameter only applies when [Low Power Mode](#) is enabled.

Scan one of the following barcodes to set the time the scanner remains active before entering low power mode. The scanner wakes upon trigger press or when the host attempts to communicate with the scanner.



1 Second
(17)

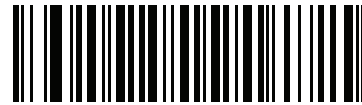

10 Seconds
(26)



1 Minute
(33)



5 Minutes
(37)



15 Minutes
(43)

Time Delay to Low Power Mode (continued)



30 Minutes
(45)



45 Minutes
(46)



*** 1 Hour**
(49)

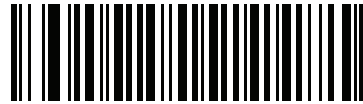

3 Hours
(51)

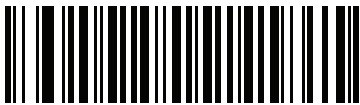

6 Hours
(54)

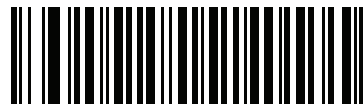

9 Hours
(57)

Trigger Mode

Parameter # 138

SSI # 8Ah

Scan one of the following barcodes to select a trigger mode for the scanner:

- **Standard (Level)** - A trigger press activates decode processing. Decode processing continues until the barcode decodes, you release the trigger, or the [Decode Session Timeout on page 80](#) occurs.
- *** Presentation (Blink)** - The scanner activates decode processing when it detects a barcode in its field of view. After a period of non-use, the LEDs turn off until the scanner senses motion..

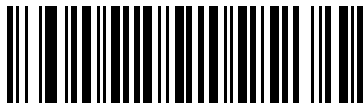

Standard (Level)
(0)

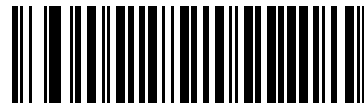

*** Presentation (Blink)**
(7)

Hand-held Decode Aiming Pattern

Parameter # 306

SSI # F0h 32h



NOTE: The decode aiming pattern flashes even if you disable the **Hand-held Decode Aiming Pattern** if the trigger button is pressed.

Scan one of the following barcodes to select when to project the aiming pattern in hand-held mode:

- **Enable Hand-held Decode Aiming Pattern** - This projects the aiming pattern during barcode capture.
- **Disable Hand-held Decode Aiming Pattern** - This turns the aiming pattern off.
- **Enable Hand-held Decode Aiming Pattern on PDF** - This projects the aiming pattern when the scanner detects a PDF barcode.

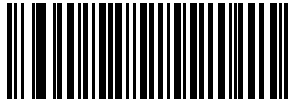

* **Enable Hand-held Decode Aiming Pattern**
(2)

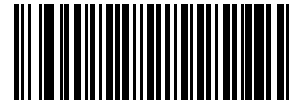

Disable Hand-held Decode Aiming Pattern
(0)



Enable Hand-held Decode Aiming Pattern on PDF
(3)

Presentation (Hands-free) Decode Aiming Pattern

Parameter # 590

SSI # F1h 4Eh

Scan one of the following barcodes to select when to project the aiming pattern in hands-free mode:

- **Enable Presentation (Hands-free) Decode Aiming Pattern** - This projects the aiming pattern during barcode capture.
- **Disable Presentation (Hands-free) Decode Aiming Pattern** - This turns the aiming pattern off.
- **Enable Presentation (Hands-free) Decode Aiming Pattern on PDF** - This projects the aiming pattern when the scanner detects a PDF barcode.



NOTE: With [Momentary Trigger Mode Timeout on page 77](#) enabled, the decode aiming pattern flashes even when you disable the **Hands-free Decode Aiming Pattern**.



**Enable Presentation (Hands-free)
Decode Aiming Pattern
(1)**



*** Disable Presentation (Hands-free)
Decode Aiming Pattern
(0)**



**Enable Presentation (Hands-free)
Decode Aiming Pattern on PDF
(2)**

Momentary Trigger Mode Timeout

Parameter # 2030

SSI # EDh

In momentary trigger mode, the aiming pattern appears upon pressing the trigger. Once in this mode, upon each trigger press the scanner attempts to decode the barcode in front of it. After a period of inactivity while the trigger is not pressed, the scanner reverts to presentation mode where there is no illumination until an item is presented.

Scan one of the following barcodes to set the length of the period of inactivity in momentary trigger mode before the scanner reverts to presentation mode.



2 Seconds
(20)



3 Seconds
(30)



4 Seconds
(40)



*** 5 Seconds**
(50)

Picklist Mode

Parameter # 402

SSI # F0h 92h

Scan one of the following barcodes to select a Picklist Mode. In this mode, you can pick out and decode a barcode from a group of barcodes that are printed close together by placing the aiming pattern on the barcode you want to decode.



NOTES: Enabling Picklist Mode overrides the Disable Decode Aiming Pattern options. You can not disable the decode aiming pattern when Picklist Mode is enabled.

Enabling Picklist Mode can slow decode speed and hinder the ability to decode longer barcodes.

- **Enable Picklist Mode Always** - Picklist Mode is always enabled.
- **Enable Picklist Mode in Hand-held Mode** - Picklist Mode is enabled when the scanner is out of hands-free mode and disabled when the scanner is in presentation mode.
- **Enable Picklist Mode in Hands-free Mode** - Picklist Mode is enabled when the scanner is in hands-free mode only.



NOTE: When using **Picklist Mode in Hands-free Mode**, increase the time of the [Timeout Between Decodes, Same Symbol](#) on page 80.

- **Disable Picklist Mode Always** - Picklist Mode is always disabled.

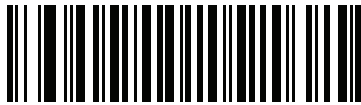

Enable Picklist Mode Always
(2)



*** Enable Picklist Mode in Hand-held Mode**
(1)



Enable Picklist Mode in Hands-free Mode
(3)



Disable Picklist Mode Always
(0)

Continuous Barcode Read

Parameter # 649

SSI # F1h 89h

Scan **Enable Continuous Barcode Read** to report every barcode while the trigger is pressed.



NOTE: We strongly recommend enabling [Momentary Trigger Mode Timeout on page 77](#) with this parameter. Disabling Picklist Mode can cause accidental decodes when more than one barcode is in the scanner's field of view.



Enable Continuous Barcode Read
(1)

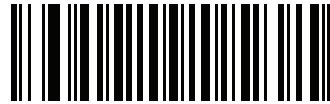

*** Disable Continuous Barcode Read**
(0)

Unique Barcode Reporting

Parameter # 723

SSI # F1h D3h

Scan **Enable Continuous Barcode Read Uniqueness** to report only unique barcodes while the trigger is pressed. This option only applies when [Continuous Barcode Read](#) is enabled.



*** Enable Unique Barcode Reporting**
(1)



Disable Unique Barcode Reporting
(0)

Decode Session Timeout

Parameter # 136

SSI # 88h

This parameter sets the maximum time decode processing continues during a scan attempt. It is programmable in 0.1 second increments from 0.5 to 9.9 seconds. The default timeout is 9.9 seconds.

To set a Decode Session Timeout, scan the following barcode, and then scan two barcodes from [Numeric Barcodes](#) that correspond to the desired on time. Enter a leading zero for single digit numbers. For example, to set a Decode Session Timeout of 0.5 seconds, scan this barcode, and then scan the **0** and **5** barcodes. To correct an error or change the selection, scan [Cancel](#).



Decode Session Timeout

Timeout Between Decodes, Same Symbol

Parameter # 137

SSI # 89h

Use this option in presentation mode or [Continuous Barcode Read](#) mode to prevent the scanner from continuously decoding the same barcode when it is left in the scanner's field of view. The barcode must be out of the field of view for the timeout period before the scanner reads the same consecutive symbol. It is programmable in 0.1 second increments from 0.0 to 9.9 seconds. The default interval is 0.5 seconds.

To select the timeout between decodes for the same symbol, scan the following barcode, and then scan two barcodes from [Numeric Barcodes](#) that correspond to the desired interval, in 0.1 second increments.



Timeout Between Decodes, Same Symbol

Timeout Between Decodes, Different Symbols

Parameter # 144

SSI # 90h

Use this option in presentation mode or [Continuous Barcode Read](#) to control the time the scanner waits before decoding a different symbol. It is programmable in 0.1 second increments from 0.1 to 9.9 seconds. The default is 0.1 seconds.

To select the timeout between decodes for different symbols, scan the following barcode, and then scan two barcodes from [Numeric Barcodes](#) that correspond to the desired interval, in 0.1 second increments.



NOTE: Timeout Between Decodes, Different Symbols cannot be greater than or equal to the [Decode Session Timeout](#).

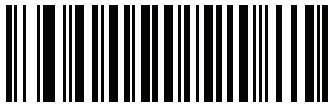

Timeout Between Decodes, Different Symbols

Triggered Timeout, Same Symbol

Parameter # 724 (SSI # F1h D4h)



NOTE: This feature does not apply to Timeout Between Decodes, Different Symbols.



NOTE: Timeout Between Decodes, Same Symbol cannot be greater than or equal to the Time Delay to Low Power Mode (parameter #146 on page [72](#)).

Scan **Enable Triggered Timeout, Same Symbol** below to apply **Timeout Between Decodes, Same Symbol** (parameter #137 on page [80](#)) in hand-held trigger mode. Subsequent scans of **Enable Triggered Timeout, Same Symbol** are ignored until **Timeout Between Decodes, Same Symbol** expires.



Enable Triggered Timeout, Same Symbol
(1)



* Disable Triggered Timeout, Same Symbol
(0)

Mobile Phone/Display Mode

Parameter # 716

SSI # F1h CCh

This mode improves barcode reading performance off mobile phones and electronic displays. Scan one of the following barcodes to select the desired mode.



* Normal Mobile Phone/Display Mode
(0)

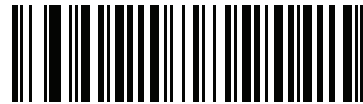

Enhanced in Hand-held Mode
(1)



Enhanced in Hands-free Mode
(2)

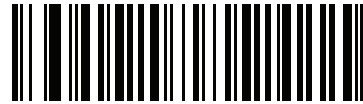

Enhanced in Both Modes
(3)

PDF Prioritization

Parameter # 719

SSI # F1h CFh

Scan **Enable PDF Prioritization** to delay decoding certain 1D barcodes (see *Note* below) by the value specified in [PDF Prioritization Timeout](#). During that time the scanner attempts to decode a PDF417 symbol (e.g., on a US driver's license), and if successful, reports this only. If it does not decode (can not find) a PDF417 symbol, it reports the 1D symbol after the timeout. The 1D symbol must be in the device's field of view for the scanner to report it. This parameter does not affect decoding other symbologies.



NOTE: To use PDF Prioritization in hand-held mode, you must disable [Picklist Mode](#).



NOTE: The 1D Code 128 barcode lengths include the following:

- 7 to 10 characters
- 14 to 22 characters
- 27 to 28 characters

In addition, a Code 39 barcode with the following lengths are considered to potentially be part of a US driver's license:

- 8 characters
- 12 characters

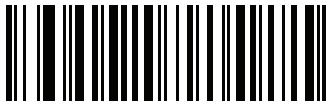

**Enable PDF Prioritization
(1)**

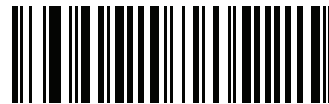

*** Disable PDF Prioritization
(0)**

PDF Prioritization Timeout

Parameter # 720

SSI # F1h D0h

If you enabled [PDF Prioritization](#), set this timeout to indicate how long the scanner attempts to decode a PDF417 symbol before reporting the 1D barcode in the field of view.

Scan the following barcode, and then scan four barcodes from [Numeric Barcodes](#) that specify the timeout in milliseconds. For example, to enter 400 ms, scan the following barcode, and then scan 0400. The range is 0 to 5000 ms, and the default is 200 ms.



PDF Prioritization Timeout

Decoding Illumination

Parameter # 298

SSI # F0h 2Ah

Scan one of the following barcodes to determine whether the scanner turns on illumination to aid decoding. Enabling illumination usually results in superior images and better decode performance. The effectiveness of the illumination decreases as the distance to the target increases.



NOTE: This parameter only applies to triggered mode, and not to presentation mode.



* Enable Decoding Illumination
(1)



Disable Decoding Illumination
(0)

Illumination Brightness

Parameter # 669

SSI # F1h 9Dh

Scan one of the following barcodes to set the illumination brightness used during an active decode session. This only applies in hand-held mode (not in presentation mode).



NOTE: Selecting a lower brightness level can affect decode performance.



**Low Illumination Brightness
(0)**



**Medium Illumination Brightness
(3)**



*** High Illumination Brightness
(10)**

Motion Tolerance (Hand-held Trigger Modes Only)

Parameter # 858

SSI # F2h 5Ah

Scan one of the following barcodes to select a motion tolerance option:

- **Less Motion Tolerance** - This provides optimal decoding performance on 1D barcodes.
- **More Motion Tolerance** - This increases motion tolerance and speeds decoding when scanning a series of 1D barcodes in rapid progression.



* **Less Motion Tolerance**
(0)



More Motion Tolerance
(1)

Product ID (PID) Type

Parameter # 1281

SSI # F8h 05h 01h

Scan one of the following barcodes to define the PID value reported in USB enumeration.



* **Host Type Unique**
(0)

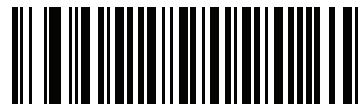

Product Unique
(1)



IBM Unique
(2)

Product ID (PID) Value

Parameter # 1725

SSI # F8h 06h BDh

To set a Product ID value, scan **Set PID Value**, and then scan four numeric barcodes in [Numeric Barcodes](#) that correspond to the value. Enter a leading zero for single digit numbers. To correct an error, or change a selection, scan [Cancel on page 441](#). The range is (0,1600-1649).



NOTE: This parameter is applicable to customers using a Firmware Flash Update per the Toshiba Global Commerce Solutions (TGCS) Universal Serial Bus OEM Point-of-Sale Device Interface.



Set PID Value

ECLevel

Parameter # 1710

SSI # F8h 06h AEh

To set an ECLevel value, scan **Set ECLevel**, and then scan five numeric barcodes in [Numeric Barcodes](#) that correspond to the desired level. Enter a leading zero for single digit numbers. To correct an error, or change a selection, scan [Cancel on page 441](#).



NOTE: This parameter is applicable to customers using a Firmware Flash Update per the Toshiba Global Commerce Solutions (TGCS) Universal Serial Bus OEM Point-of-Sale Device Interface. It allows a customer to define an ECLevel value in order to manage and control Flash Update operations on the 4690 operating system.

Contact the Zebra Customer Support Center online at: www.zebra.com/support for more information.



Set ECLevel

Miscellaneous Scanner Parameters

Enter Key

Scan the following barcode to add an Enter key (carriage return/line feed) after scanned data. To program other prefixes and/or suffixes, see [Prefix/Suffix Values on page 90](#).

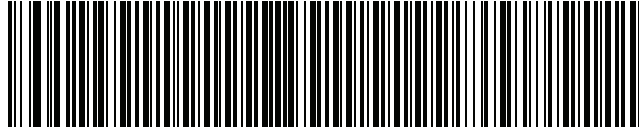

Add Enter Key (Carriage Return/Line Feed)

Tab Key

Scan the following barcode to add a Tab key after scanned data.

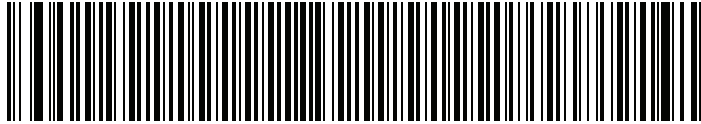

Tab Key

Transmit Code ID Character

Parameter # 45

SSI # 2Dh

A Code ID character identifies the code type of a scanned barcode. This is useful when decoding more than one code type. In addition to any single character prefix selected, the Code ID character is inserted between the prefix and the decoded symbol.

Select no Code ID character, a Symbol Code ID character, or an AIM Code ID character. For Code ID characters, see [Symbol Code Identifiers on page 471](#) and [AIM Code Identifiers on page 472](#).



NOTE: If you enable Symbol Code ID Character or AIM Code ID Character, and enable [Transmit "No Read" Message on page 94](#), the scanner appends the code ID for Code 39 to the NR message.

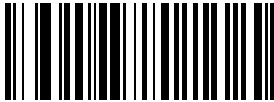

**Symbol Code ID Character
(2)**

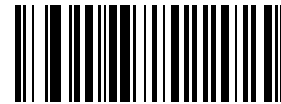

**AIM Code ID Character
(1)**

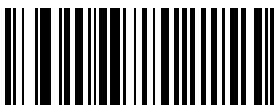

*** None
(0)**

Prefix/Suffix Values

Key Category Parameter # P = 99, S1 = 98, S2 = 100

SSI # P = 63h, S1 = 62h, S2 = 64h

Decimal Value Parameter # P = 105, S1 = 104, S2 = 106

SSI # P = 69h, S1 = 68h, S2 = 6Ah



NOTE: To use Prefix/Suffix values, first set the [Scan Data Transmission Format on page 91](#).

You can append a prefix and/or one or two suffixes to scan data for use in data editing. To set a value for a prefix or suffix, scan one of the following barcodes, and then scan four barcodes from [Numeric Barcodes](#) that correspond to that value. See [ASCII Character Sets](#) for the four-digit codes.

When using host commands to set the prefix or suffix, set the key category parameter to 1, and then set the 3-digit decimal value. See [ASCII Character Sets](#) for the four-digit codes.

The default prefix and suffix value is 7013 <CR><LF> (Enter key). To correct an error or change a selection, scan [Cancel on page 441](#).

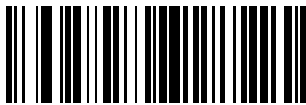

**Scan Prefix
(7)**



**Scan Suffix 1
(6)**



**Scan Suffix 2
(8)**



Data Format Cancel

Scan Data Transmission Format

Parameter # 235

SSI # EBh



NOTE: If using this parameter do not use ADF rules to set the prefix/suffix.

To change the scan data format, scan one of the following barcodes corresponding to the desired format.

To set values for the prefix and/or suffix, see [Prefix/Suffix Values on page 90](#).



* Data As Is
(0)



<DATA> <SUFFIX 1>
(1)



<DATA> <SUFFIX 2>
(2)



<DATA> <SUFFIX 1> <SUFFIX 2>
(3)

Scan Data Transmission Format (continued)



<PREFIX> <DATA >
(4)



<PREFIX> <DATA> <SUFFIX 1>
(5)



<PREFIX> <DATA> <SUFFIX 2>
(6)



<PREFIX> <DATA> <SUFFIX 1> <SUFFIX 2>
(7)

FN1 Substitution Values

Key Category Parameter # 103

Key Category SSI # 67h

Decimal Value Parameter # 109

Decimal Value SSI # 6Dh

Keyboard wedge and USB HID keyboard hosts support a FN1 substitution feature. Enabling this substitutes any FN1 character (0x1b) in an EAN128 barcode with a value. This value defaults to 7013 <CR><LF> (Enter key).

When using host commands to set the FN1 substitution value, set the key category parameter to 1, and then set the 3-digit keystroke value. See the ASCII Character Set table for the current host interface for the desired value.

To select a FN1 substitution value via barcode menus:

1. Scan the following barcode.

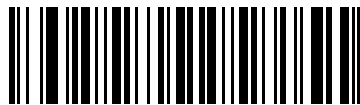

Set FN1 Substitution Value

2. Locate the keystroke desired for FN1 Substitution in the ASCII Character Set table for the current host interface, and enter the 4-digit ASCII value by scanning four barcodes from [Numeric Barcodes](#).

To correct an error or change the selection, scan **Cancel**.

To enable FN1 substitution for USB HID keyboard, scan **Enable USB Keyboard FN1 Substitution** on page [247](#).

To enable FN1 substitution for keyboard wedge, scan **Enable FN1 Substitution** on page [314](#).

Transmit “No Read” Message

Parameter # 94

SSI # 5Eh

Scan one of the following barcodes to set an option for transmitting the No Read (NR) characters.



NOTE: If you enable **Transmit No Read**, and also enable Symbol Code ID Character or AIM Code ID Character for [Transmit Code ID Character on page 89](#), the scanner appends the code ID for Code 39 to the NR message.



NOTE: This does not apply in presentation mode.

- **Enable No Read** - This transmits the characters NR when a successful decode does not occur before trigger release or the **Decode Session Timeout** expires. See [Decode Session Timeout on page 80](#).
- **Disable No Read** - This sends nothing to the host if a symbol does not decode.



**Enable No Read
(1)**



*** Disable No Read
(0)**

Unsolicited Heartbeat Interval

Parameter # 1118

SSI # F8h 04h 5Eh

The scanner can send unsolicited heartbeat messages to assist in diagnostics. To enable this parameter and set the desired unsolicited heartbeat interval, scan one of the following time interval barcodes, or scan **Set Another Interval** followed by four barcodes from [Numeric Barcodes](#) that correspond to the desired number of seconds.

Scan **Disable Unsolicited Heartbeat Interval** to turn off the feature.

The heartbeat event is sent as decode data (with no decode beep) in the form of:

MOTEVTHB:nnn

where **nnn** is a three-digit sequence number starting at 001 and wrapping after 100.

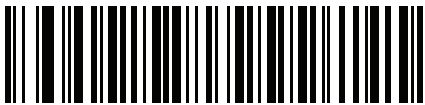

10 Seconds
(10)



1 Minute
(60)



Set Another Interval



*** Disable Unsolicited Heartbeat Interval**
(0)

securPharm Decoding

Parameter # 1752

SSI # F8h 06h D8h

securPharm implements the IFA and GS1 Coding System for the European pharmaceutical industry. securPharm code is used to prevent pharmaceutical counterfeiting.

When this feature is enabled, if a GS1 symbol is decoded and includes any aspects of the Application Identifier associated with the securPharm GS1 specifications, the entire GS1 symbol is processed as a securPharm symbol. For this reason, it is expected that under certain circumstances, a GS1 barcode that is a securPharm symbol may not be processed properly; if the GS1 symbol is not created as per the specification. The output cannot be guaranteed as valid.

Although the GS1-128 type and the GS1 DataBar family are not specifically indicated in the IFA specification, they are supported.

The securPharm output is in XML format and can include the product number, serial number, lot number, expiration and Date of Manufacturing. The XML tags can be arranged in any order. Tags that are not in the barcode are omitted. For example:

```
<content dfi="value_dfi">  
<Daten_1>value_Daten_1</Daten_1>  
<Daten_2>value_Daten_2</Daten_2>  
<Daten_n>value_Daten_n</Daten_n>  
</content>
```

Where:

value_dfi = IFA or GS1

Daten_1 to Daten_n is the production number, serial number, etc.

Scan a barcode below to enable or disable the ability to process pharmaceutical type barcodes.



*** Disable securPharm Decoding
(0)**



**Enable securPharm Decoding
(1)**

securPharm Output Formatting

Parameter # 1753

SSI # F8h 06h D9h



NOTE: securPharm output formatting is effective only when [securPharm Decoding on page 96](#) is enabled.

securPharm Output Formatting parameter options represent bit positions. Therefore, any combination of formatting can be used.

When you scan a securPharm Output Formatting barcode, the securPharm output is formatted in a number of ways.

Sample GS1 Format

Product Number: GTIN Data Identifier DI Data Format Identifier: GS1

Data Carrier

*FNC1*04150123456782

101A234B5*FNC1*

1717231



> Scanned Barcode >

```
<content dfi="GS1">
<gtin>04150123456782</gtin>
  <lot>1A234B5</lot>
  <exp>151231</exp>
  <sn>1234567890123456</sn>
</content>
```

Sample GS1 Output - Feature Disabled

The output has no format:

0104150123456782101A234B517151231211234567890123456

Sample GS1 Output - No Formatting (0)

The output is a single line of characters:

```
<content
dfi="GS1"><gtin>04150123456782</gtin><lot>1A234B5</lot><exp>151231</exp><sn>1234567890123456</sn></content>
```

Sample GS1 Output - Insert Tab (1)

The output is a single line of characters with a tab inserted in the XML body:

```
<content
dfi="GS1">[tab]<gtin>04150123456782</gtin>[tab]<lot>1A234B5</lot>[tab]<exp>151231</exp>[tab]<sn>12345
67890123456</sn></content>
```

Sample GS1 Output - Insert New Line (2)

The output consists of multiple lines of characters with a new line character at the end of each line.

```
<content dfi="GS1">
<gtin>04150123456782</gtin>
<lot>1A234B5</lot>
<exp>151231</exp>
<sn>1234567890123456</sn>
</content>
```

Sample GS1 Output - Insert Tab and New Line (3)

The output consists of multiple lines of characters with tabs and a new line character at the end of each line.

```
<content dfi="GS1">
[tab]<gtin>04150123456782</gtin>
[tab]<lot>1A234B5</lot>
[tab]<exp>151231</exp>
[tab]<sn>1234567890123456</sn>
</content>
```

Sample IFA Format

Product Number: PPNData Identifier DI Data Format Identifier: IFA

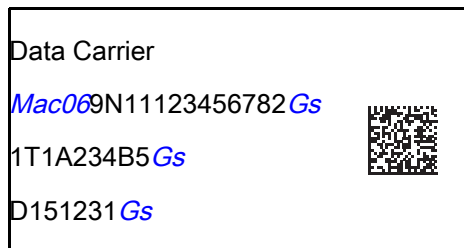

> Scanned Barcode >

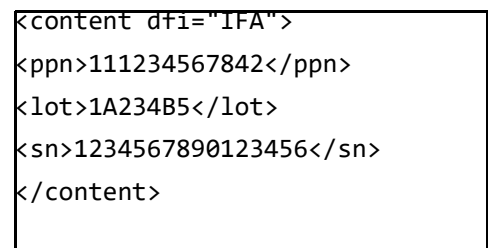

Sample GS1 Output - Feature Disabled

The output has no format:

```
[ ]>069N1112345678421T1A234B5S1234567890123456
```

Sample GS1 Output - No Formatting (0)

The output is a single line of characters:

```
<content
dfi="IFA"><ppn>111234567842</ppn><lot>1A234B5</lot><sn>1234567890123456</sn></content>
```

Sample GS1 Output - Insert Tab (1)

The output is a single line of characters with a tab inserted in the XML body:

```
<content
dfi="IFA">[tab]<ppn>111234567842</ppn>[tab]<lot>1A234B5</lot>[tab]<sn>1234567890123456</sn></content>
```

Sample GS1 Output - Insert New Line (2)

The output consists of multiple lines of characters with a new line character at the end of each line.

```
<content dfi="IFA">
<ppn>111234567842</ppn>
<lot>1A234B5</lot>
<sn>1234567890123456</sn>
</content>
```

Sample GS1 Output - Insert Tab and New Line (3)

The output consists of multiple lines of characters with tabs and a new line character at the end of each line.

```
<content dfi="IFA">  
[tab]<ppn>111234567842</ppn>  
[tab]<lot>1A234B5</lot>  
[tab]<sn>1234567890123456</sn>  
</content>
```

securPharm Output Formatting Barcodes

Scan a barcode below to format the securPharm output.



*** No Formatting
(0)**



**Insert Tab
(1)**



**Insert New Line
(2)**



**Insert Tab and New Line
(3)**

Imager Preferences

Introduction

You can program the imager to perform various functions, or activate different features. This chapter describes image capture preference features and provides programming barcodes for selecting these features.



NOTE: Only the Symbol Native API (SNAPI) with Imaging interface supports image capture. See [USB Device Type on page 239](#) to enable this host.

The imager ships with the settings shown in [Table 9 on page 101](#) (also see [Parameter Defaults](#) for all defaults). If the default values suit requirements, programming is not necessary.

Setting Parameters

To set feature values, scan a single barcode or a short barcode sequence. The settings are stored in non-volatile memory and are preserved even when the imager powers down.



NOTE: Most computer monitors allow scanning barcodes directly on the screen. When scanning from the screen, be sure to set the document magnification to a level where you can see the barcode clearly, and bars and/or spaces do not merge.

To return all features to default values, scan the [Set Factory Defaults on page 62](#). Throughout the programming barcode menus, asterisks (*) indicate default values.



* Indicates default — * Enable Parameter — Feature/option
(1) — Option value

Scanning Sequence Examples

In most cases scanning one barcode sets the parameter value. For example, to disable image capture illumination, scan the **Disable Image Capture Illumination** barcode under [Image Capture Illumination on page 104](#). The imager issues a fast warble beep and the LED turns green, signifying a successful parameter entry.

Other parameters require scanning several barcodes. See the parameter descriptions for this procedure.

Errors While Scanning

Unless otherwise specified, to correct an error during a scanning sequence, just re-scan the correct parameter.

Image Capture Preferences Parameter Defaults

[Table 9](#) lists defaults for image capture preference parameters. Change these values in one of two ways:

- Scan the appropriate barcodes in this chapter. The new value replaces the standard default value in memory. To recall default parameter values, see [Default Parameters on page 62](#).
- Configure the scanner using the 123Scan configuration program. See [123Scan and Software Tools](#).



NOTE: See [Parameter Defaults](#) for all user preference, host, symbology, and miscellaneous default parameters.

Table 9 Image Capture Preferences Parameter Defaults

Parameter	Parameter Number ¹	SSI Number ²	Default	Page Number
Image Capture Preferences				
Operational Modes	N/A	N/A	N/A	103
Image Capture Illumination	361	F0h 69h	Enable	104
Image Capture Autoexposure	360	F0h 68h	Enable	104
Fixed Exposure	567	F4h F1h 37h	100	105
Analog Gain	1232	F4h D0h	Analog Gain x 2	106
Digital Gain	1233	F4h D1h	32	106
Gain / Exposure Priority for Snapshot Mode	562	F1h 32h	Autodetect	107
Snapshot Mode Timeout	323	F0h 43h	0 (30 seconds)	108
Snapshot Aiming Pattern	300	F0h 2Ch	Enable	109
Silence Operational Mode Changes	1293	F8h 05h 0Dh	Disable (do not silence)	109
Image Cropping	301	F0h 2Dh	Disable	110

1. Parameter number decimal values are used for programming via RSM commands.

2. SSI number hex values are used for programming via SSI commands.

Imager Preferences

Table 9 Image Capture Preferences Parameter Defaults (Continued)

Parameter	Parameter Number ¹	SSI Number ²	Default	Page Number
Crop to Pixel Addresses	315 316 317 318	F4h F0h 3Bh F4h F0h 3Ch F4h F0h 3Dh F4h F0h 3Eh	0 top 0 left 799 bottom 1279 right	110
Image Size (Number of Pixels)	302	F0h 2Eh	Full	112
Image Brightness (Target White)	390	F0h 86h	180	113
JPEG Image Options	299	F0h 2Bh	Quality	113
JPEG Quality Value	305	F0h 31h	65	114
JPEG Size Value	561	F1h 31h	160 kB	114
Image Enhancement	564	F1h 34h	Low (1)	115
Image File Format Selection	304	F0h 30h	JPEG	116
Image Rotation	665	F1h 99h	0	117
Bits per Pixel (BPP)	303	F0h 2Fh	8 BPP	118
Signature Capture	93	5Dh	Disable	119
Signature Capture Image File Format Selection	313	F0h 39h	JPEG	120
Signature Capture Bits per Pixel (BPP)	314	F0h 3Ah	8 BPP	121
Signature Capture Width	366	F4h F0h 6Eh	400	122
Signature Capture Height	367	F4h F0h 6Fh	100	122
Signature Capture JPEG Quality	421	F0h A5h	65	122

1. Parameter number decimal values are used for programming via RSM commands.

2. SSI number hex values are used for programming via SSI commands.

Image Capture Preferences

The parameters in this chapter control image capture characteristics.

Operational Modes

The imager has two modes of operation:

- Decode Mode
- Snapshot Mode

Decode Mode

By default, when you press the trigger the imager attempts to locate and decode enabled barcodes within its field of view. The imager remains in this mode until it decodes a barcode or you release the trigger.

Snapshot Mode

Use Snapshot Mode to capture a high-quality image and transmit it to the host. Scan the **Snapshot Mode** barcode to temporarily enter this mode. While in this mode the imager blinks the green LED at one-second intervals to indicate it is not in standard operating (decode) mode.

In Snapshot Mode, the imager turns on its aiming pattern to highlight the area to capture in the image. The next trigger press instructs the imager to capture a high quality image and transmit it to the host. A short time may pass (less than two seconds) between when the trigger is pressed and the image is captured as the imager adjusts to lighting conditions. Hold the imager steady until a single beep indicates that it captured the image.

If you do not press the trigger within the Snapshot Mode Timeout period, the imager returns to Decode Mode. Use [Snapshot Mode Timeout on page 108](#) to adjust this timeout period. The default timeout period is 30 seconds.

To disable the aiming pattern during Snapshot Mode, see [Snapshot Aiming Pattern on page 109](#).



Snapshot Mode

Image Capture Illumination

Parameter # 361

SSI # F0h 69h

Scan **Enable Image Capture Illumination** to turn on illumination during every image capture. This usually results in superior images. The effectiveness of illumination decreases as the distance to the target increases.

Scan **Disable Image Capture Illumination** to prevent the imager from using illumination.

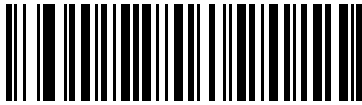

* Enable Image Capture Illumination
(1)

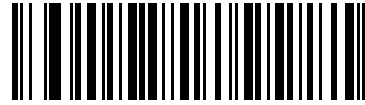

Disable Image Capture Illumination
(0)

Image Capture Autoexposure

Parameter # 360

SSI # F0h 68h

Scan **Enable Image Capture Autoexposure** to allow the imager to control gain settings and exposure (integration) time to best capture an image for the selected operation mode.

Scan **Disable Image Capture Autoexposure** to manually adjust the gain and exposure time (see the following pages). This option is only recommended for advanced users with difficult image capture situations.

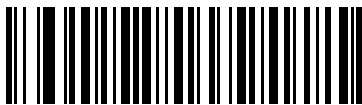

* Enable Image Capture Autoexposure
(1)

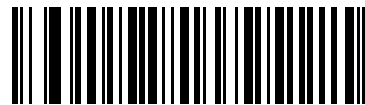

Disable Image Capture Autoexposure
(0)

Fixed Exposure

Parameter # 567

SSI # F4h F1h 37h

Type: Word

Range: 5 to 30,000

This parameter configures the exposure used in manual mode for Snapshot mode.

Each integer value represents 100 μ s of exposure. The default value is 100 which results in an exposure setting of 10 ms.

To set the exposure, scan the **Fixed Exposure** barcode, and then scan four numeric barcodes from [Numeric Barcodes](#) representing the value. Leading zeros are required. For example, to set a Fixed Exposure value of 99, scan 0, 0, 9, 9.



Fixed Exposure
(4 digits)

Analog and Digital Gain

If you disable [Image Capture Autoexposure](#) you can modify the engine's analog and digital gain using these parameters. Total gain = analog gain x digital gain.

Analog Gain

Parameter # 1232

SSI # F4h D0h

Select an option to set an analog gain value.

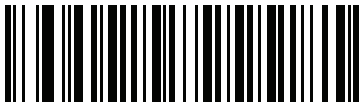

Analog Gain x 1
(00h)

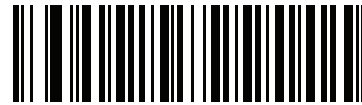

* Analog Gain x 2
(01h)

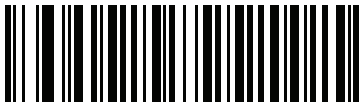

Analog Gain x 4
(02h)

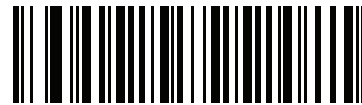

Analog Gain x 8
(03h)

Digital Gain

Parameter # 1233

SSI # F4h D1h

To set the digital gain, scan the following barcode, then scan two barcodes from [Numeric Barcodes](#) to enter a 2-digit value for the digital gain. The default is 32.

A value of 32 = x 1 digital gain; i.e., digital gain = 1/32 x digital gain parameter value.



Digital Gain

Gain/Exposure Priority for Snapshot Mode

Parameter # 562

SSI # F1h 32h

This parameter alters the imager's gain exposure priority when it acquires an image in Snapshot Mode while in autoexposure mode. Scan one of the following barcodes:

- **Low Exposure Priority** - The imager favors higher gain over exposure to capture an image, resulting in an image that is less susceptible to motion blur at the expense of noise artifacts. However, for most applications, the amount of noise is acceptable.
- **Low Gain Priority** - The imager favors longer exposure time rather than higher gain to capture an image, ensuring the image is less noisy and produces fewer artifacts during post processing activities like image enhancement (sharpening). This mode is recommended for fixed mount / fixed object image capture since the image acquired is susceptible to motion blur.
- **Autodetect** (default) - The imager automatically selects Gain Priority or Low Exposure Priority mode for Snapshot Mode. If the imager is in a magnetic reed switch-enabled stand (or it is configured in Blink Mode), it uses Low Gain Priority. Otherwise, it uses the Low Exposure Priority.



Low Gain Priority
(0)



Low Exposure Priority
(1)



*** Autodetect**
(2)

Snapshot Mode Timeout

Parameter # 323

SSI # F0h 43h

This parameter sets the amount of time the imager remains in Snapshot Mode. The imager exits Snapshot Mode when you press the trigger, or when the Snapshot Mode Timeout elapses. To set this timeout value, scan the **Set Snapshot Mode Timeout** barcode, and then scan a barcode from [Numeric Barcodes](#). The default value is 0 which represents 30 seconds; values increment by 30. For example, 0 = 30 seconds, 1 = 60 seconds, 2 = 90 seconds, etc. The maximum timeout value that can be set on the scanner is 9 = 300 seconds.

To quickly re-set the default timeout to 30 seconds, scan the **30 Seconds** barcode.

If you scan **No Timeout**, the imager remains in Snapshot Mode until you press the trigger.



Set Snapshot Mode Timeout

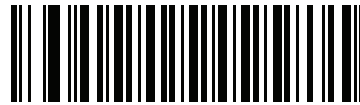

*** 30 Seconds**



No Timeout

Snapshot Aiming Pattern

Parameter # 300

SSI # F0h 2Ch

Scan one of the following barcodes to select whether or not to project the aiming pattern when in Snapshot Mode.



NOTE: If enabled, the aiming pattern frames the image for aiming purposes and does not appear in the captured image.



* Enable Snapshot Aiming Pattern
(1)



Disable Snapshot Aiming Pattern
(0)

Silence Operational Mode Changes

Parameter # 1293

SSI # F8h 05h 0Dh

Scan **Silence Operational Mode Changes** to silence the beeper when switching between operational modes (e.g., from Decode Mode to Snapshot Mode).



Silence Operational Mode Changes (Enable)
(1)

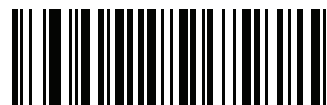

* Do Not Silence Operational Mode Changes (Disable)
(0)

Image Cropping

Parameter # 301

SSI # F0h 2Dh

Scan the **Enable Image Cropping** barcode to crop a captured image to the pixel addresses set in [Crop to Pixel Addresses on page 110](#). Scan **Disable Image Cropping** to present the full 1280 x 800 pixels.



Enable Image Cropping
(1)



* Disable Image Cropping
(Use Full 1280 x 800 Pixels)
(0)

Crop to Pixel Addresses

Parameter # 315

SSI # F4h F0h 3Bh (Top)

Parameter # 316

SSI # F4h F0h 3Ch (Left)

Parameter # 317

SSI # F4h F0h 3Dh (Bottom)

Parameter # 318

SSI # F4h F0h 3Eh (Right)



NOTE: The imager has a cropping resolution of 4 pixels. Setting the cropping area to less than 4 pixels (after resolution adjustment, see [Image Size \(Number of Pixels\) on page 112](#)) transfers the entire image.

If you enabled [Image Cropping](#), set the pixel addresses from (0,0) to (1279 x 799) to crop to.

Columns are numbered from 0 to 1279, rows from 0 to 799. Specify values for Top, Left, Bottom, and Right, where Top and Bottom correspond to row pixel addresses, and Left and Right correspond to column pixel addresses. For example, for a 4 row x 8 column image in the extreme bottom-right section of the image, set the following values:

Top = 796, Bottom = 799, Left = 1272, Right = 1279

To set the pixel addresses, scan each of the following barcodes, and then scan four numeric barcodes from [Numeric Barcodes](#) representing the value. Leading zeros are required. For example, to crop the top pixel address to 3, scan 0, 0, 0, 3. The defaults are:

Top = 0, Bottom = 799, Left = 0, Right = 1279

Crop to Pixel Address (continued)



Top Pixel Address
(0 - 799 Decimal)



Left Pixel Address
(0 - 1279 Decimal)



Bottom Pixel Address
(0 - 799 Decimal)



Right Pixel Address
(0 - 1279 Decimal)

Image Size (Number of Pixels)

Parameter # 302

SSI # F0h 2Eh

This option alters image resolution before compression. Multiple pixels are combined to one pixel, resulting in a smaller image containing the original content with reduced resolution.

Scan a barcode below to select an image size.

Table 10 Image Size

Resolution Value	Uncropped Image Size
Full	1280 x 800
1/2	640 x 400
1/4	320 x 200



*** Full Resolution
(0)**



**1/2 Resolution
(1)**



**1/4 Resolution
(3)**

Image Brightness (Target White)

Parameter # 390

SSI # F0h 86h

Type: Byte

Range: 1 - 240

This parameter sets the Target White value used in Snapshot mode when using autoexposure. White and black are defined as 240 decimal and 1, respectively. Setting the value to the factory default of 180 sets the white level of the image to ~180.

Scan the **Image Brightness** barcode, and then scan three numeric barcodes from [Numeric Barcodes](#) representing the value. Leading zeros are required. For example, to set an Image Brightness value of 99, scan 0, 9, 9.



* 180



Image Brightness
(3 digits)

JPEG Image Options

Parameter # 299

SSI # F0h 2Bh

Scan one of the following barcodes to optimize JPEG images for either size or quality:

- **JPEG Quality Selector** - Enter a quality value via the [JPEG Quality Value](#) parameter; the imager then selects the corresponding image size.
- **JPEG Size Selector** - Enter a size value via the [JPEG Size Value](#) parameter; the imager then selects the best image quality.



* JPEG Quality Selector
(1)



JPEG Size Selector
(0)

JPEG Quality Value

Parameter # 305

SSI # F0h 31h

If you selected **JPEG Quality Selector**, scan the **JPEG Quality Value** barcode, and then scan three barcodes from [Numeric Barcodes](#) corresponding to a value from 5 to 100, where 100 represents the highest quality image. Leading zeros are required. For example, to set an image quality value of 55, scan 0, 5, 5.



JPEG Quality Value
(Default: 065)
(5 - 100 Decimal)

JPEG Size Value

Parameter # 561

SSI # F1h 31h

Type: Word

Range: 5-350

If you selected **JPEG Size Selector**, scan the **JPEG Size Value** barcode, and then scan three numeric barcodes from [Numeric Barcodes](#) representing the target JPEG file size in kilobytes (KB). Leading zeros are required. For example, to set an image file size value of 99, scan 0, 9, 9.



CAUTION: JPEG compression may take 10 to 15 seconds based on the amount of information in the target image. Scanning JPEG Quality Selector (default setting) on [page 113](#) produces a compressed image that is consistent in quality and compression time.



JPEG Size Value
(Default: 160)
(3 digits)

Image Enhancement

Parameter # 564

SSI # F1h 34h

This parameter uses a combination of edge sharpening and contrast enhancement to produce an image that is visually pleasing.

Scan one of the following barcodes to select the level of image enhancement:

- Off (0)
- Low (1) - Default
- Medium (2)
- High (3)



**Off
(0)**



*** Low
(1)**



**Medium
(2)**



**High
(3)**

Image File Format Selector

Parameter # 304

SSI # F0h 30h

Scan one of the following barcodes to select an image format appropriate for the system (BMP, TIFF, or JPEG). The imager stores captured images in the selected format.



**BMP File Format
(3)**



*** JPEG File Format
(1)**



**TIFF File Format
(04h)**

Image Rotation

Parameter # 665

SSI # F1h 99h

Scan one of the following barcodes to rotate the image 0, 90, 180, or 270 degrees.



* Rotate 0°
(0)

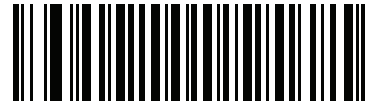

Rotate 90°
(1)



Rotate 180°
(2)

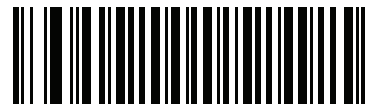

Rotate 270°
(3)

Bits Per Pixel

Parameter # 303

SSI # F0h 2Fh

Scan one of the following barcodes to select the number of significant bits per pixel (BPP) to use when capturing an image:

- **1 BPP** - For a black and white image.
- **4 BPP** - Assigns 1 of 16 levels of grey to each pixel.
- **8 BPP** - Assigns 1 of 256 levels of grey to each pixel.



NOTE: The imager ignores these settings for JPEG file formats, which only support **8 BPP**.

TIFF file formats only support **4 BPP** and **8 BPP**. Selecting **1 BPP** for TIFF applies the **4 BPP** option.



1 BPP
(0)



4 BPP
(1)



*** 8 BPP**
(2)

Signature Capture

Parameter # 93

SSI # 5Dh

A signature capture barcode is a special-purpose symbology which delineates a signature capture area in a document with a machine-readable format. The recognition pattern is variable so it can optionally provide an index to various signatures. The region inside the barcode pattern is considered the signature capture area. See [Signature Capture](#) for more information.

Output File Format

Decoding a signature capture barcode de-skews the signature image and converts the image to a BMP, JPEG, or TIFF file format. The output data includes the file descriptor followed by the formatted signature image.

Table 11 Output File Format

File Descriptor			Signature Image
Output Format (1 byte)	Signature Type (1 byte)	Signature Image Size (4 bytes) (BIG Endian)	
JPEG - 1 BMP - 3 TIFF - 4	1-8	0x00000400	0x00010203....

Scan one of the following barcodes to enable or disable Signature Capture.



Enable Signature Capture
(1)



*** Disable Signature Capture**
(0)

Signature Capture File Format Selector

Parameter # 313

SSI # F0h 39h

Scan one of the following barcodes to select a signature file format appropriate for the system (BMP, TIFF, or JPEG). The imager stores captured signatures in the selected format.



**BMP Signature Format
(3)**



*** JPEG Signature Format
(1)**



**TIFF Signature Format
(4)**

Signature Capture Bits Per Pixel

Parameter # 314

SSI # F0h 3Ah

Scan one of the following barcodes to select the number of significant bits per pixel (BPP) to use when capturing a signature:

- **1 BPP** - For a black and white image.
- **4 BPP** - Assigns 1 of 16 levels of grey to each pixel.
- **8 BPP** - Assigns 1 of 256 levels of grey to each pixel.



NOTE: The imager ignores these settings for JPEG file formats, which only support **8 BPP**.



1 BPP
(0)



4 BPP
(1)



*** 8 BPP**
(2)

Signature Capture Width

Parameter # 366

SSI # F4h F0h 6Eh

The aspect ratio of the Signature Capture Width and Signature Capture Height parameters must match that of the signature capture area. For example, a 4 x 1 inch signature capture area requires a 4 to 1 aspect ratio of width to height.

To set the width of the signature capture box, scan the **Signature Capture Width** barcode, and then scan four barcodes from [Numeric Barcodes](#) corresponding to a value in the range of 16 to 1280 decimal.

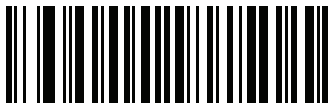

Signature Capture Width (Default: 400)
(16 - 1280 Decimal)

Signature Capture Height

Parameter # 367

SSI # F4h F0h 6Fh

To set the height of the signature capture box, scan the **Signature Capture Height** barcode, and then scan three barcodes from [Numeric Barcodes](#) corresponding to a value in the range of 16 to 960 decimal.



Signature Capture Height (Default: 100)
(16 - 960 Decimal)

Signature Capture JPEG Quality

Parameter # 421

SSI # F0h A5h

Scan the **JPEG Quality Value** barcode, and then scan three barcodes from [Numeric Barcodes](#) corresponding to a value from 005 to 100, where 100 represents the highest quality image.



JPEG Quality Value (Default: 065)
(5 - 100 Decimal)

Symbologies

Introduction

You can program the scanner to perform various functions, or activate different features. This chapter describes symbology features and provides programming barcodes for selecting these features.

The scanner ships with the settings shown in [Table 12 on page 125](#) (also see [Parameter Defaults](#) for all defaults). If the default values suit requirements, programming is not necessary.

Setting Parameters

To set feature values, scan a single barcode or a short barcode sequence. The settings are stored in non-volatile memory and are preserved even when the scanner powers down.



NOTE: Most computer monitors allow scanning barcodes directly on the screen. When scanning from the screen, be sure to set the document magnification to a level where you can see the barcode clearly, and bars and/or spaces do not merge.

If not using a USB cable, select a host type (see each host chapter for specific host information) after the power-up beeps sound. This is only necessary upon the first power-up when connected to a new host.

To return all features to default values, see [Default Parameters on page 62](#). Throughout the programming barcode menus, asterisks (*) indicate default values.



* Indicates default * Enable Parameter Feature/option

Scanning Sequence Examples

In most cases, scanning one barcode sets the parameter value. For example, to transmit barcode data without the UPC-A check digit, scan the **Do Not Transmit UPC-A Check Digit** barcode under [Transmit UPC-A Check Digit on page 143](#). The scanner issues a fast warble beep and the LED turns green, signifying a successful parameter entry.

Other parameters require scanning several barcodes. See the parameter descriptions for this procedure.

Errors While Scanning

Unless otherwise specified, to correct an error during a scanning sequence, just re-scan the correct parameter.

Symbology Parameter Defaults

[Table 12](#) lists defaults for all symbology parameters. Change these values in one of two ways:

- Scan the appropriate barcodes in this chapter. The new value replaces the standard default value in memory. To recall the default parameter values, see [Default Parameters on page 62](#).
- Configure the scanner using the 123Scan configuration program. See [123Scan and Software Tools](#).



NOTE: See [Parameter Defaults](#) for all user preference, host, symbology, and miscellaneous default parameters.

Table 12 Symbology Parameter Defaults

Parameter	Parameter Number ¹	SSI Number ²	Default	Page Number
Enable/Disable All Code Types				132
1D Symbologies				
UPC/EAN/JAN				
UPC-A	1	01h	Enable	132
UPC-E	2	02h	Enable	133
UPC-E1	12	0Ch	Disable	133
EAN-8/JAN 8	4	04h	Enable	134
EAN-13/JAN 13	3	03h	Enable	134
Bookland EAN	83	53h	Disable	135
Bookland ISBN Format	576	F1h 40h	ISBN-10	136
ISSN EAN	617	F1h 69h	Disable	137
Decode UPC/EAN/JAN Supplementals (2 and 5 digits)	16	10h	Ignore	138

1. Parameter number decimal values are used for programming via RSM commands.

2. SSI number hex values are used for programming via SSI commands.

Table 12 Symbology Parameter Defaults (Continued)

Parameter	Parameter Number ¹	SSI Number ²	Default	Page Number
User-Programmable Supplementals			000	141
Supplemental 1:	579	F1h 43h		
Supplemental 2:	580	F1h 44h		
UPC/EAN/JAN Supplemental Redundancy	80	50h	10	141
Decode UPC/EAN/JAN Supplemental AIM ID	672	F1h A0h	Combined	142
Transmit UPC-A Check Digit	40	28h	Enable	143
Transmit UPC-E Check Digit	41	29h	Enable	143
Transmit UPC-E1 Check Digit	42	2Ah	Enable	144
UPC-A Preamble	34	22h	System Character	145
UPC-E Preamble	35	23h	System Character	146
UPC-E1 Preamble	36	24h	System Character	147
Convert UPC-E to UPC-A	37	25h	Disable	148
Convert UPC-E1 to UPC-A	38	26h	Disable	148
EAN/JAN Zero Extend	39	27h	Disable	149
UCC Coupon Extended Code	85	55h	Disable	149
Coupon Report	730	F1h DAh	New Coupon Format	150
UPC Reduced Quiet Zone	1289	F8h 05h 09h	Disable	151
Code 128				
Code 128	8	08h	Enable	151
Set Length(s) for Code 128	209, 210	D1h, D2h	Any Length	152
GS1-128 (formerly UCC/EAN-128)	14	0Eh	Enable	153
ISBT 128	84	54h	Enable	154
ISBT Concatenation	577	F1h 41h	Disable	154
Check ISBT Table	578	F1h 42h	Enable	155
ISBT Concatenation Redundancy	223	DFh	10	156
Code 128 <FNC4>	1254	F8h 04h E6h	Honor	156
Code 128 Security Level	751	F1h EFh	Security Level 1	157
Code 128 Reduced Quiet Zone	1208	F8h 04h B8h	Disable	158

1. Parameter number decimal values are used for programming via RSM commands.

2. SSI number hex values are used for programming via SSI commands.

Table 12 Symbology Parameter Defaults (Continued)

Parameter	Parameter Number ¹	SSI Number ²	Default	Page Number
Code 39				
Code 39	0	00h	Enable	158
Trioptic Code 39	13	0Dh	Disable	159
Convert Code 39 to Code 32 (Italian Pharmacy Code)	86	56h	Disable	159
Code 32 Prefix	231	E7h	Disable	160
Set Length(s) for Code 39	18, 19	12h, 13h	1 to 55	160
Code 39 Check Digit Verification	48	30h	Disable	162
Transmit Code 39 Check Digit	43	2Bh	Disable	162
Code 39 Full ASCII Conversion	17	11h	Disable	163
Code 39 Security Level	750	F1h EEh	Security Level 1	164
Code 39 Reduced Quiet Zone	1209	F8h 04h B9h	Disable	165
Code 93				
Code 93	9	09h	Enable	165
Set Length(s) for Code 93	26, 27	1Ah, 1Bh	1 to 55	166
Code 11				
Code 11	10	0Ah	Disable	168
Set Lengths for Code 11	28, 29	1Ch, 1Dh	4 to 55	168
Code 11 Check Digit Verification	52	34h	Disable	170
Transmit Code 11 Check Digit(s)	47	2Fh	Disable	171
Interleaved 2 of 5 (ITF)				
Interleaved 2 of 5 (ITF)	6	06h	Enable	171
Set Lengths for I 2 of 5	22, 23	16h, 17h	6 to 55	172
I 2 of 5 Check Digit Verification	49	31h	Disable	173
Transmit I 2 of 5 Check Digit	44	2Ch	Disable	174
Convert I 2 of 5 to EAN 13	82	52h	Disable	174
Febraban	1750	F8h 06h D6h	Disable	175
I 2 of 5 Security Level	1121	F8h 04h 61h	Security Level 1	176
I 2 of 5 Reduced Quiet Zone	1210	F8h 04h BAh	Disable	177

1. Parameter number decimal values are used for programming via RSM commands.

2. SSI number hex values are used for programming via SSI commands.

Table 12 Symbology Parameter Defaults (Continued)

Parameter	Parameter Number ¹	SSI Number ²	Default	Page Number
Discrete 2 of 5 (DTF)				
Discrete 2 of 5	5	05h	Disable	177
Set Length(s) for D 2 of 5	20, 21	14h 15h	1 to 55	178
Codabar (NW - 7)				
Codabar	7	07h	Enable	180
Set Lengths for Codabar	24, 25	18h, 19h	4 to 55	180
CLSI Editing	54	36h	Disable	182
NOTIS Editing	55	37h	Disable	182
Codabar Security Level	1776	F8h 06h F0h	Security Level 1	183
Codabar Upper or Lower Case Start/ Stop Characters Detection	855	F2h 57h	Upper Case	184
Codabar Mod 16 Check Digit Verification	1784	F8h 06h F8h	Disable	184
Transmit Codabar Check Digit	704	F1h C0h	Disable	185
MSI				
MSI	11	0Bh	Disable	185
Set Length(s) for MSI	30, 31	1Eh, 1Fh	4 to 55	186
MSI Check Digits	50	32h	One MSI Check Digit	188
Transmit MSI Check Digit	46	2Eh	Disable	188
MSI Check Digit Algorithm	51	33h	Mod 10/Mod 10	190
MSI Reduced Quiet Zone	1392	F8h 05h 70h	Disable	190
Chinese 2 of 5				
Chinese 2 of 5	408	F0h 98h	Disable	191
Matrix 2 of 5				
Matrix 2 of 5	618	F1h 6Ah	Disable	191
Matrix 2 of 5 Lengths	619 620	F1h 6Bh F1h 6Ch	4 to 55	192
Matrix 2 of 5 Check Digit	622	F1h 6Eh	Disable	194
Transmit Matrix 2 of 5 Check Digit	623	F1h 6Fh	Disable	194

1. Parameter number decimal values are used for programming via RSM commands.

2. SSI number hex values are used for programming via SSI commands.

Table 12 Symbology Parameter Defaults (Continued)

Parameter	Parameter Number ¹	SSI Number ²	Default	Page Number
Korean 3 of 5				
Korean 3 of 5	581	F1h 45h	Disable	195
Inverse 1D				
Inverse 1D	586	F1h 4Ah	Regular	195
GS1 DataBar				
GS1 DataBar Omnidirectional (formerly GS1 DataBar-14), GS1 DataBar Truncated, GS1 DataBar Stacked, GS1 DataBar Stacked Omnidirectional	338	F0h 52h	Enable	197
GS1 DataBar Limited	339	F0h 53h	Enable	198
GS1 DataBar Expanded, GS1 DataBar Expanded Stacked	340	F0h 54h	Enable	198
Convert GS1 DataBar to UPC/EAN/JAN	397	F0h 8Dh	Disable	199
GS1 DataBar Security Level	1706	F8h 06h AAh	Level 1	200
GS1 DataBar Limited Margin Check	728	F1h D8h	Level 3	201
Symbology-Specific Security Features				
Redundancy Level	78	4Eh	1	202
Security Level	77	4Dh	1	204
1D Quiet Zone Level	1288	F8h 05h 08h	1	205
Intercharacter Gap Size	381	F0h 7Dh	Normal	206
Composite Codes				
Composite CC-C	341	F0h 55h	Disable	206
Composite CC-A/B	342	F0h 56h	Disable	207
Composite TLC-39	371	F0h 73h	Disable	207
Composite Inverse	1113	F8h 04h 59h	Regular Only	207
UPC Composite Mode	344	F0h 58h	UPC Never Linked	209
Composite Beep Mode	398	F0h 8Eh	Beep As Each Code Type is Decoded	210
GS1-128 Emulation Mode for UCC/EAN Composite Codes	427	F0h ABh	Disable	210

1. Parameter number decimal values are used for programming via RSM commands.

2. SSI number hex values are used for programming via SSI commands.

Table 12 Symbology Parameter Defaults (Continued)

Parameter	Parameter Number ¹	SSI Number ²	Default	Page Number
2D Symbologies				
PDF417	15	0Fh	Enable	211
MicroPDF417	227	E3h	Disable	211
Code 128 Emulation	123	7Bh	Disable	212
Data Matrix	292	F0h 24h	Enable	213
GS1 Data Matrix	1336	F8h 05h 38h	Disable	213
Data Matrix Inverse	588	F1h 4Ch	Inverse Autodetect	214
Decode Data Matrix Mirror Images	537	F1h 19h	Auto	215
Maxicode	294	F0h 26h	Disable	216
QR Code	293	F0h 25h	Enable	216
Weblink QR	1947	F7 07 9B	Enable	217
GS1 QR	1343	F8h 05h 3Fh	Enable	218
MicroQR	573	F1h 3Dh	Enable	218
Linked QR Mode	1847	737h	Linked QR Only	219
Aztec	574	F1h 3Eh	Enable	220
Aztec Inverse	589	F1h 4Dh	Inverse Autodetect	220
Han Xin	1167	F8h 04h 8Fh	Disable	221
Han Xin Inverse	1168	F8h 04h 90h	Regular	221
Grid Matrix	1718	F8h 06h B6h	Disable	222
Grid Matrix Inverse	1719	F8h 06h B7h	Regular Only	222
Grid Matrix Mirror	1736	F8h 06h C8h	Regular Only	223
DotCode	1906	F8 07 72h	Disable	224
DotCode Inverse	1907	F8 07 73h	Inverse Autodetect	225
DotCode Mirrored	1908	F8 07 74h	Autodetect	226
DotCode Prioritize	1937	F8 07 91h	Enable	227
Macro PDF				
Flush Macro PDF Buffer	N/A	N/A	N/A	228
Abort Macro PDF Entry	N/A	N/A	N/A	228

1. Parameter number decimal values are used for programming via RSM commands.

2. SSI number hex values are used for programming via SSI commands.

Table 12 Symbology Parameter Defaults (Continued)

Parameter	Parameter Number ¹	SSI Number ²	Default	Page Number
Postal Codes				
US Postnet	89	59h	Disable	228
US Planet	90	5Ah	Disable	229
Transmit US Postal Check Digit	95	5Fh	Enable	229
UK Postal	91	5Bh	Disable	230
Transmit UK Postal Check Digit	96	60h	Enable	230
Japan Postal	290	F0h 22h	Disable	231
Australia Post	291	F0h 23h	Disable	231
Australia Post Format	718	F1h CEh	Autodiscriminate	232
Netherlands KIX Code	326	F0h 46h	Disable	233
USPS 4CB/One Code/Intelligent Mail	592	F1h 50h	Disable	233
UPU FICS Postal	611	F1h 63h	Disable	234
Mailmark	1337	F8h 05h 39h	Disable	234

1. Parameter number decimal values are used for programming via RSM commands.

2. SSI number hex values are used for programming via SSI commands.

Enable/Disable All Code Types

Scan the **Disable All Code Types** barcode to disable all symbologies. This is useful when enabling only a few code types.

Scan **Enable All Code Types** to enable all symbologies. This is useful if you need to disable only a few code types.

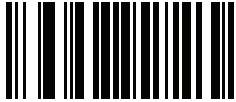

Disable All Code Types



Enable All Code Types

UPC/EAN/JAN

UPC-A

Parameter # 1

SSI # 01h

Scan one of the following barcodes to enable or disable UPC-A.

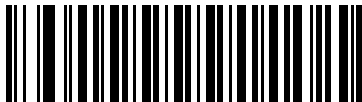

*** Enable UPC-A
(1)**

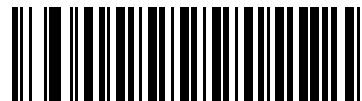

**Disable UPC-A
(0)**

UPC-E

Parameter # 2

SSI # 02h

Scan one of the following barcodes to enable or disable UPC-E.

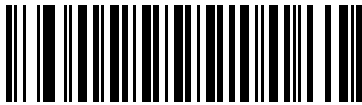

*** Enable UPC-E
(1)**

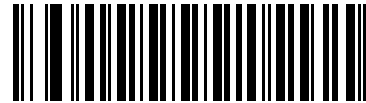

**Disable UPC-E
(0)**

UPC-E1

Parameter # 12

SSI # 0Ch

Scan one of the following barcodes to enable or disable UPC-E1.



NOTE: UPC-E1 is not a UCC (Uniform Code Council) approved symbology.

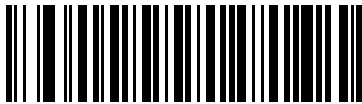

**Enable UPC-E1
(1)**

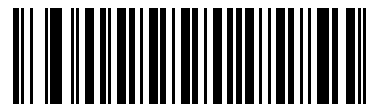

*** Disable UPC-E1
(0)**

EAN-8/JAN-8

Parameter # 4

SSI # 04h

Scan one of the following barcodes to enable or disable EAN-8/JAN-8.

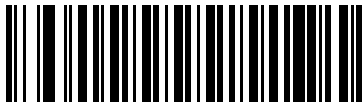

* Enable EAN-8/JAN-8
(1)

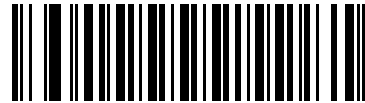

Disable EAN-8/JAN-8
(0)

EAN-13/JAN-13

Parameter # 3

SSI # 03h

Scan one of the following barcodes to enable or disable EAN-13/JAN-13.



* Enable EAN-13/JAN-13
(1)

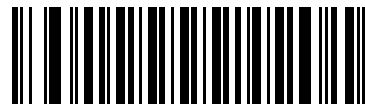

Disable EAN-13/JAN-13
(0)

Bookland EAN

Parameter # 83

SSI # 53h



NOTE: If you enable Bookland EAN, select a [Bookland ISBN Format](#). Also set [Decode UPC/EAN/JAN Supplementals on page 138](#) to either Decode UPC/EAN/JAN with Supplementals Only, Autodiscriminate UPC/EAN/JAN With Supplementals, or Enable 978/979 Supplemental Mode.

Scan one of the following barcodes to enable or disable Bookland EAN.

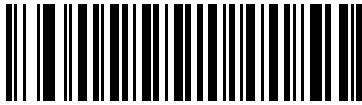

**Enable Bookland EAN
(1)**



*** Disable Bookland EAN
(0)**

Bookland ISBN Format

Parameter # 576

SSI # F1h 40h



NOTE: For Bookland EAN to function properly, first enable Bookland EAN using [Bookland EAN on page 135](#), and then set [Decode UPC/EAN/JAN Supplementals on page 138](#) to either Decode UPC/EAN/JAN with Supplementals Only, Autodiscriminate UPC/EAN/JAN With Supplementals, or Enable 978/979 Supplemental Mode.

If you enabled Bookland EAN using [Bookland EAN on page 135](#), select one of the following formats for Bookland data:

- **Bookland ISBN-10** - The scanner reports Bookland data starting with 978 in traditional 10-digit format with the special Bookland check digit for backward-compatibility. Data starting with 979 is not considered Bookland in this mode.
- **Bookland ISBN-13** - The scanner reports Bookland data (starting with either 978 or 979) as EAN-13 in 13-digit format to meet the 2007 ISBN-13 protocol.



* **Bookland ISBN-10**
(0)



Bookland ISBN-13
(1)

ISSN EAN

Parameter # 617

SSI # F1h 69h

Scan one of the following barcodes to enable or disable ISSN EAN.



**Enable ISSN EAN
(1)**

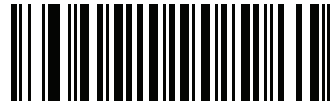

*** Disable ISSN EAN
(0)**

Decode UPC/EAN/JAN Supplementals

Parameter # 16

SSI # 10h

Supplementals are barcodes appended according to specific format conventions (e.g., UPC A+2, UPC E+2, EAN 13+2). The following options are available:

- **Decode UPC/EAN/JAN with Supplementals Only** - The scanner only decodes UPC/EAN/JAN symbols with supplemental characters, and ignores symbols without supplementals.
- **Ignore UPC/EAN/JAN Supplementals** - When presented with a UPC/EAN/JAN plus supplemental symbol, the scanner decodes UPC/EAN/JAN and ignores the supplemental characters.
- **Autodiscriminate UPC/EAN/JAN with Supplementals** - The scanner decodes UPC/EAN/JAN symbols with supplemental characters immediately. If the symbol does not have a supplemental, the scanner must decode the barcode the number of times set via [UPC/EAN/JAN Supplemental Redundancy on page 141](#) before transmitting its data to confirm that there is no supplemental.

Select one of the following **Supplemental Mode** options to immediately transmit EAN-13 barcodes starting with that prefix that have supplemental characters. If the symbol does not have a supplemental, the scanner must decode the barcode the number of times set via [UPC/EAN/JAN Supplemental Redundancy on page 141](#) before transmitting the data to confirm that there is no supplemental. The scanner transmits UPC/EAN/JAN barcodes that do not have that prefix immediately.

- **Enable 378/379 Supplemental Mode**
- **Enable 978/979 Supplemental Mode**



NOTE: If you select 978/979 Supplemental Mode and are scanning Bookland EAN barcodes, see [Bookland EAN on page 135](#) to enable Bookland EAN, and select a format using [Bookland ISBN Format on page 136](#).

- **Enable 977 Supplemental Mode**
- **Enable 414/419/434/439 Supplemental Mode**
- **Enable 491 Supplemental Mode**
- **Enable Smart Supplemental Mode** - This applies to EAN-13 barcodes starting with any prefix listed previously.
- **Supplemental User-Programmable Type 1** - This applies to EAN-13 barcodes starting with a 3-digit user-defined prefix. Set this using [User-Programmable Supplementals on page 141](#).
- **Supplemental User-Programmable Type 1 and 2** - This applies to EAN-13 barcodes starting with either of two 3-digit user-defined prefixes. Set the prefixes using [User-Programmable Supplementals on page 141](#).
- **Smart Supplemental Plus User-Programmable 1** - This applies to EAN-13 barcodes starting with any prefix listed previously or the prefix set using [User-Programmable Supplementals on page 141](#).
- **Smart Supplemental Plus User-Programmable 1 and 2** - This applies to EAN-13 barcodes starting with any prefix listed previously or one of the two user-defined prefixes set using [User-Programmable Supplementals on page 141](#).

Decode UPC/EAN/JAN Supplementals (continued)



NOTE: To minimize the risk of invalid data transmission, select either to decode or ignore supplemental characters.



**Decode UPC/EAN/JAN With Supplementals Only
(1)**



*** Ignore UPC/EAN/JAN Supplementals
(0)**

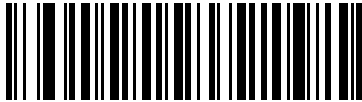

**Autodiscriminate UPC/EAN/JAN with Supplementals
(2)**



**Enable 378/379 Supplemental Mode
(4)**



**Enable 978/979 Supplemental Mode
(5)**



**Enable 977 Supplemental Mode
(7)**

Decode UPC/EAN/JAN Supplementals (continued)



Enable 414/419/434/439 Supplemental Mode
(6)



Enable 491 Supplemental Mode
(8)



Enable Smart Supplemental Mode
(3)



Supplemental User-Programmable Type 1
(9)



Supplemental User-Programmable Type 1 and 2
(10)



Smart Supplemental Plus User-Programmable 1
(11)



Smart Supplemental Plus User-Programmable 1 and 2
(12)

User-Programmable Supplementals

Supplemental 1: Parameter # 579

SSI # F1h 43h

Supplemental 2: Parameter # 580

SSI # F1h 44h

If you selected a Supplemental User-Programmable option from [Decode UPC/EAN/JAN Supplementals on page 138](#), scan **User-Programmable Supplemental 1**, and then scan three barcodes from [Numeric Barcodes](#) to set the 3-digit prefix. To set a second 3-digit prefix, scan **User-Programmable Supplemental 2**, and then scan three barcodes from [Numeric Barcodes](#). The default is 000 (zeroes).



User-Programmable Supplemental 1



User-Programmable Supplemental 2

UPC/EAN/JAN Supplemental Redundancy

Parameter # 80

SSI # 50h

If you selected Autodiscriminate UPC/EAN/JAN Supplementals, this option adjusts the number of times to decode a symbol without supplementals before transmission. The range is from two to thirty times. Five or above is recommended when decoding a mix of UPC/EAN/JAN symbols with and without supplementals. The default is 10.

Scan the barcode below to set a decode redundancy value. Next, scan two numeric barcodes in [Numeric Barcodes](#). Enter a leading zero for single digit numbers. To correct an error or change a selection, scan [Cancel on page 441](#).



UPC/EAN/JAN Supplemental Redundancy

UPC/EAN/JAN Supplemental AIM ID Format

Parameter # 672

SSI # F1h A0h

If [Transmit Code ID Character on page 89](#) is set to **AIM Code ID Character**, scan one of the following barcodes to select an output format when reporting UPC/EAN/JAN barcodes with supplementals:

- **Separate** - Transmit UPC/EAN/JAN with supplementals with separate AIM IDs but one transmission, i.e.,
]E<0 or 4><data>]E<1 or 2>[supplemental data]
- **Combined** – Transmit UPC/EAN/JAN with supplementals with one AIM ID and one transmission, i.e.,
]E3<data+supplemental data>
- **Separate Transmissions** - Transmit UPC/EAN/JAN with supplementals with separate AIM IDs and separate transmissions, i.e.,
]E<0 or 4><data>
]E<1 or 2>[supplemental data]



**Separate
(0)**



*** Combined
(1)**



**Separate Transmissions
(2)**

Transmit UPC-A Check Digit**Parameter # 40****SSI # 28h**

The check digit is the last character of the symbol used to verify the integrity of the data. Scan one of the following barcodes to transmit the barcode data with or without the UPC-A check digit. It is always verified to guarantee the integrity of the data.

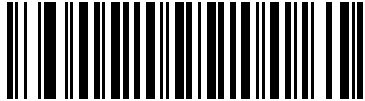

*** Transmit UPC-A Check Digit
(1)**

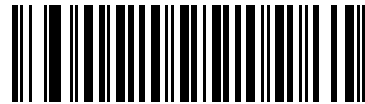

**Do Not Transmit UPC-A Check Digit
(0)**

Transmit UPC-E Check Digit**Parameter # 41****SSI # 29h**

The check digit is the last character of the symbol used to verify the integrity of the data. Scan one of the following barcodes to transmit the barcode data with or without the UPC-E check digit. It is always verified to guarantee the integrity of the data.

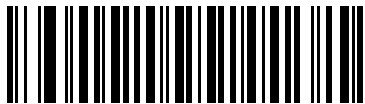

*** Transmit UPC-E Check Digit
(1)**



**Do Not Transmit UPC-E Check Digit
(0)**

Transmit UPC-E1 Check Digit

Parameter # 42

SSI # 2Ah

The check digit is the last character of the symbol used to verify the integrity of the data. Scan one of the following barcodes to transmit the barcode data with or without the UPC-E1 check digit. It is always verified to guarantee the integrity of the data.



*** Transmit UPC-E1 Check Digit
(1)**

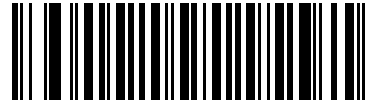

**Do Not Transmit UPC-E1 Check Digit
(0)**

UPC-A Preamble

Parameter # 34

SSI # 22h

Preamble characters are part of the UPC symbol, and include Country Code and System Character. Select the appropriate option for transmitting a UPC-A preamble to match the host system:

- Transmit System Character only
- Transmit System Character and Country Code ("0" for USA)
- Transmit no preamble.



No Preamble (<DATA>)
(0)

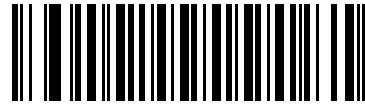

*** System Character**
(<SYSTEM CHARACTER> <DATA>)
(1)

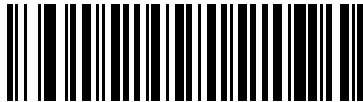

System Character & Country Code
(< COUNTRY CODE> <SYSTEM CHARACTER> <DATA>)
(2)

UPC-E Preamble

Parameter # 35

SSI # 23h

Preamble characters are part of the UPC symbol, and include Country Code and System Character. Select the appropriate option for transmitting a UPC-E preamble to match the host system:

- Transmit System Character only
- Transmit System Character and Country Code ("0" for USA)
- Transmit no preamble.



No Preamble (<DATA>)
(0)



*** System Character**
(<SYSTEM CHARACTER> <DATA>)
(1)

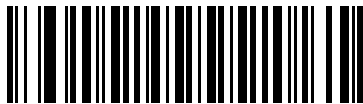

System Character & Country Code
(< COUNTRY CODE> <SYSTEM CHARACTER> <DATA>)
(2)

UPC-E1 Preamble

Parameter # 36

SSI # 24h

Preamble characters are part of the UPC symbol, and include Country Code and System Character. Select the appropriate option for transmitting a UPC-E1 preamble to match the host system:

- Transmit System Character only
- Transmit System Character and Country Code ("0" for USA)
- Transmit no preamble.

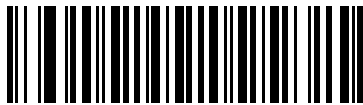

No Preamble (<DATA>)
(0)



*** System Character**
(<SYSTEM CHARACTER> <DATA>)
(1)

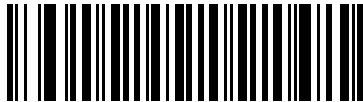

System Character & Country Code
(< COUNTRY CODE> <SYSTEM CHARACTER> <DATA>)
(2)

Convert UPC-E to UPC-A

Parameter # 37

SSI # 25h

Enable this to convert UPC-E (zero suppressed) decoded data to UPC-A format before transmission. After conversion, the data follows UPC-A format and is affected by UPC-A programming selections (e.g., Preamble, Check Digit).

Disable this to transmit UPC-E decoded data as UPC-E data, without conversion.



Convert UPC-E to UPC-A (Enable)
(1)

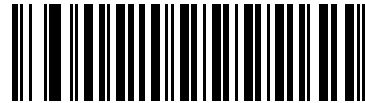

* Do Not Convert UPC-E to UPC-A (Disable)
(0)

Convert UPC-E1 to UPC-A

Parameter # 38

SSI # 26h

Scan **Convert UPC-E1 to UPC-A (Enable)** to convert UPC-E1 decoded data to UPC-A format before transmission. After conversion, the data follows UPC-A format and is affected by UPC-A programming selections (e.g., Preamble, Check Digit).

Scan **Do Not Convert UPC-E1 to UPC-A (Disable)** to transmit UPC-E1 decoded data as UPC-E1 data, without conversion.

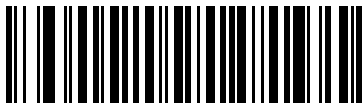

Convert UPC-E1 to UPC-A (Enable)
(1)



* Do Not Convert UPC-E1 to UPC-A (Disable)
(0)

EAN/JAN Zero Extend

Parameter # 39

SSI # 27h

Scan **Enable EAN/JAN Zero Extend** to add five leading zeros to decoded EAN-8 symbols to make them compatible in length to EAN-13 symbols. Scan **Disable EAN/JAN Zero Extend** to transmit EAN-8 symbols as is.

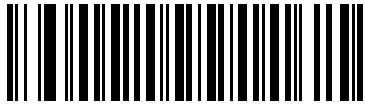

Enable EAN/JAN Zero Extend
(1)

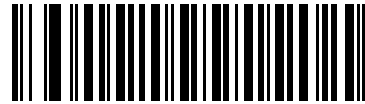

* Disable EAN/JAN Zero Extend
(0)

UCC Coupon Extended Code

Parameter # 85

SSI # 55h

Scan **Enable UCC Coupon Extended Code** to decode UPC-A barcodes starting with digit '5', EAN-13 barcodes starting with digit '99', and UPC-A/GS1-128 coupon codes. UPC-A, EAN-13, and GS1-128 must be enabled to use this feature.



NOTE: See [UPC/EAN/JAN Supplemental Redundancy on page 141](#) to control autodiscrimination of the GS1-128 portion (right half) of a coupon code.

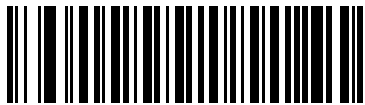

Enable UCC Coupon Extended Code
(1)



* Disable UCC Coupon Extended Code
(0)

Coupon Report

Parameter # 730

SSI # F1h DAh

Scan one of the following barcodes to select the type of coupon format to support.

- **Old Coupon Format** - Support UPC-A/GS1-128 and EAN-13/GS1-128.
- **New Coupon Format** - An interim format to support UPC-A/GS1-DataBar and EAN-13/GS1-DataBar.
- **Autodiscriminate Format** - Support both **Old Coupon Format** and **New Coupon Format**.



Old Coupon Format
(0)

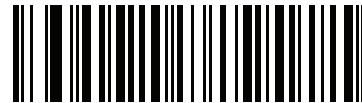

*** New Coupon Format**
(1)



Autodiscriminate Coupon Format
(2)

UPC Reduced Quiet Zone

Parameter # 1289

SSI # F8h 05h 09h

Scan one of the following barcodes to enable or disable decoding UPC barcodes with reduced quiet zones (the margins on either side of the barcode). If you select **Enable**, select a [1D Quiet Zone Level on page 205](#).

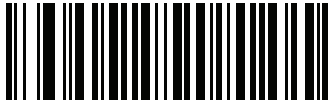

Enable UPC Reduced Quiet Zone
(1)

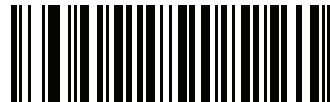

* Disable UPC Reduced Quiet Zone
(0)

Code 128

Parameter # 8

SSI # 08h

Scan one of the following barcodes to enable or disable Code 128.

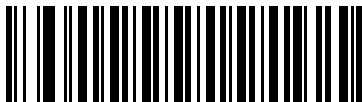

* Enable Code 128
(1)

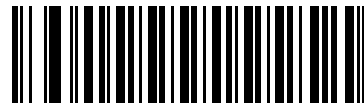

Disable Code 128
(0)

Set Lengths for Code 128

L1 = Parameter # 209

SSI # D1h

L2 = Parameter # 210

SSI # D2h

The length of a code refers to the number of characters (i.e., human readable characters), including check digit(s) the code contains. Set lengths for Code 128 to any length, one or two discrete lengths, or lengths within a specific range. The default **Any Length**.



NOTE: When setting lengths, enter a leading zero for single digit numbers.

Scan one of the following barcodes to select a length option:

- **One Discrete Length** - Decode only Code 128 symbols containing a selected length. Select the length using the barcodes in [Numeric Barcodes](#). For example, to decode only Code 128 symbols with 14 characters, scan **Code 128 - One Discrete Length**, and then scan **1, 4**. To correct an error or change the selection, scan [Cancel on page 441](#).
- **Two Discrete Lengths** - Decode only Code 128 symbols containing either of two lengths. Select lengths using the barcodes in [Numeric Barcodes](#). For example, to decode only Code 128 symbols containing either 2 or 14 characters, scan **Code 128 - Two Discrete Lengths**, and then scan **0, 2, 1, 4**. To correct an error or change the selection, scan [Cancel on page 441](#).
- **Length Within Range** - Decode Code 128 symbols with a specific length range. Select lengths using the barcodes in [Numeric Barcodes](#). For example, to decode Code 128 symbols containing between 4 and 12 characters, scan **Code 128 - Length Within Range**, and then scan **0, 4, 1, 2**. To correct an error or change the selection, scan [Cancel on page 441](#).
- **Any Length** - Decode Code 128 symbols containing any number of characters within the scanner's capability.

Set Lengths for Code 128 (continued)

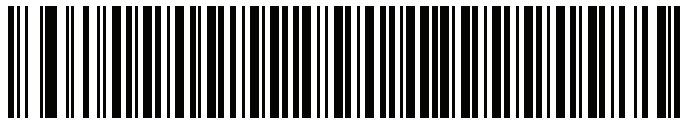

Code 128 - One Discrete Length

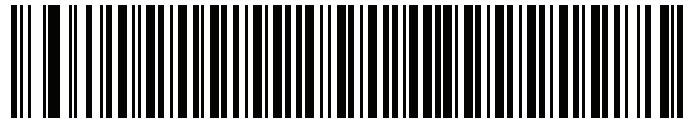

Code 128 - Two Discrete Lengths

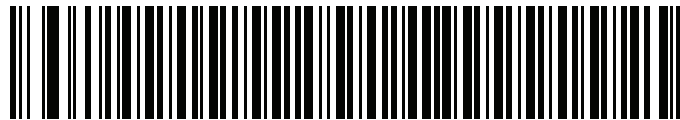

Code 128 - Length Within Range



* Code 128 - Any Length

GS1-128 (formerly UCC/EAN-128)

Parameter # 14

SSI # 0Eh

Scan one of the following barcodes to enable or disable GS1-128.

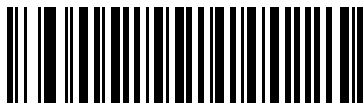

* Enable GS1-128
(1)



Disable GS1-128
(0)

ISBT 128**Parameter # 84****SSI # 54h**

ISBT 128 is a variant of Code 128 used in the blood bank industry. Scan one of the following barcodes to enable or disable ISBT 128.



* **Enable ISBT 128**
(1)



Disable ISBT 128
(0)

ISBT Concatenation**Parameter # 577****SSI # F1h 41h**

Select an option for concatenating pairs of ISBT code types:

- **Enable ISBT Concatenation** - There must be two ISBT codes in order for the scanner to decode and perform concatenation. The scanner does not decode single ISBT symbols.
- **Disable ISBT Concatenation** - The scanner does not concatenate pairs of ISBT codes it encounters. This is the default.
- **Autodiscriminate ISBT Concatenation** - The scanner decodes and concatenates pairs of ISBT codes immediately. If only a single ISBT symbol is present, the scanner must decode the symbol the number of times set via [ISBT Concatenation Redundancy on page 156](#) before transmitting its data to confirm that there is no additional ISBT symbol.



NOTE: When enabling ISBT Concatenation or Autodiscriminate ISBT Concatenation set Code 128 security level to Level 2.

ISBT Concatenation (continued)



Enable ISBT Concatenation
(1)

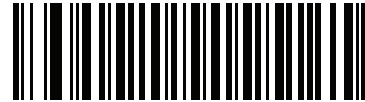

*** Disable ISBT Concatenation**
(0)

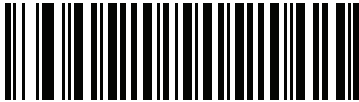

Autodiscriminate ISBT Concatenation
(2)

Check ISBT Table

Parameter # 578

SSI # F1h 42h

The ISBT specification includes a table that lists several types of ISBT barcodes that are commonly used in pairs. If you set **ISBT Concatenation** to **Enable**, enable **Check ISBT Table** to concatenate only those pairs found in this table. Other types of ISBT codes are not concatenated.



*** Enable Check ISBT Table**
(1)



Disable Check ISBT Table
(0)

ISBT Concatenation Redundancy

Parameter # 223

SSI # DFh

If you set **ISBT Concatenation** to **Autodiscriminate**, use this parameter to set the number of times the scanner must decode an ISBT symbol before determining that there is no additional symbol.

Scan the following barcode, and then scan barcodes in [Numeric Barcodes](#) to set a value between 2 and 20. Enter a leading zero for single digit numbers. To correct an error or change a selection, scan [Cancel on page 441](#). The default is 10.



ISBT Concatenation Redundancy

Code 128 <FNC4>

Parameter # 1254

SSI # F8h 04h E6h

This feature applies to Code 128 barcodes with an embedded <FNC4> character. Select **Ignore Code 128 <FNC4>** to strip the <FNC4> character from the decode data. The remaining characters are sent to the host unchanged. When disabled, the <FNC4> character is processed normally as per Code 128 standard.



* Honor Code 128 <FNC4>
(0)



Ignore Code 128 <FNC4>
(1)

Code 128 Security Level

Parameter # 751

SSI # F1h EFh

Code 128 barcodes are vulnerable to misdecodes, particularly when Code 128 Lengths is set to **Any Length**. The scanner offers four levels of decode security for Code 128 barcodes. There is an inverse relationship between security and scanner aggressiveness. Increasing the level of security can reduce scanning aggressiveness, so select only the level of security necessary.

- **Code 128 Security Level 0** - The scanner operates in its most aggressive state, while providing sufficient security in decoding most in-spec barcodes.
- **Code 128 Security Level 1** - This option eliminates most misdecodes while maintaining reasonable aggressiveness. This is the default.
- **Code 128 Security Level 2** - This option applies greater barcode security requirements if **Security Level 1** fails to eliminate misdecodes.
- **Code 128 Security Level 3** - If you selected **Security Level 2**, and misdecodes still occur, select this security level to apply the highest safety requirements.



NOTE: Selecting this option is an extreme measure against mis-decoding severely out-of-spec barcodes, and significantly impairs the decoding ability of the scanner. If this level of security is required, try to improve the quality of the barcodes.

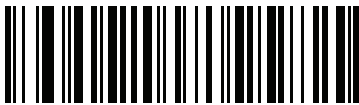

Code 128 Security Level 0
(0)



* Code 128 Security Level 1
(1)

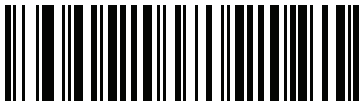

Code 128 Security Level 2
(2)



Code 128 Security Level 3
(3)

Code 128 Reduced Quiet Zone

Parameter # 1208

SSI # F8h 04h B8h

Scan one of the following barcodes to enable or disable decoding Code 128 barcodes with reduced quiet zones (the margins on either side of the barcode). If you select **Enable**, select a [1D Quiet Zone Level on page 205](#).



Enable Code 128 Reduced Quiet Zone
(1)

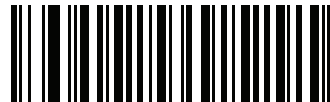

* Disable Code 128 Reduced Quiet Zone
(0)

Code 39

Parameter # 0

SSI # 00h

Scan one of the following barcodes to enable or disable Code 39.

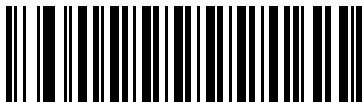

* Enable Code 39
(1)

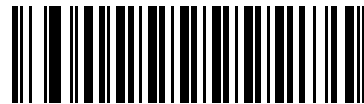

Disable Code 39
(0)

Trioptic Code 39

Parameter # 13

SSI # 0Dh

Trioptic Code 39 is a variant of Code 39 used in the marking of computer tape cartridges. Trioptic Code 39 symbols always contain six characters. Scan one of the following barcodes to enable or disable Trioptic Code 39.



NOTE: You cannot enable Trioptic Code 39 and Code 39 Full ASCII simultaneously.

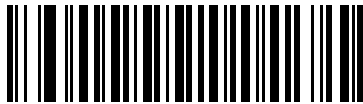

Enable Trioptic Code 39
(1)



* Disable Trioptic Code 39
(0)

Convert Code 39 to Code 32

Parameter # 86

SSI # 56h

Code 32 is a variant of Code 39 used by the Italian pharmaceutical industry. Scan one of the following barcodes to enable or disable converting Code 39 to Code 32.



NOTE: Code 39 (on page [158](#)) must be enabled for this parameter to function.

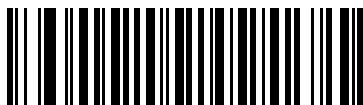

Enable Convert Code 39 to Code 32
(1)



* Disable Convert Code 39 to Code 32
(0)

Code 32 Prefix

Parameter # 231

SSI # E7h

Scan one of the following barcodes to enable or disable adding the prefix character “A” to all Code 32 barcodes.



NOTE: Convert Code 39 to Code 32 (on page 159) must be enabled for this parameter to function.



Enable Code 32 Prefix
(1)

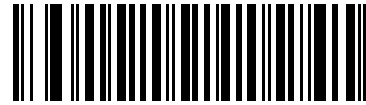

* Disable Code 32 Prefix
(0)

Set Lengths for Code 39

L1 = Parameter # 18

SSI # 12h

L2 = Parameter # 19

SSI # 13h

The length of a code refers to the number of characters (i.e., human readable characters), including check digit(s) the code contains. Set lengths for Code 128 to any length, one or two discrete lengths, or lengths within a specific range. If Code 39 Full ASCII is enabled, **Length Within Range** or **Any Length** are the preferred options. The default is **Length Within Range**: 1 to 55.



NOTE: When setting lengths, enter a leading zero for single digit numbers.

Set Lengths for Code 39 (continued)

Scan one of the following barcodes to select a length option:

- **One Discrete Length** - Decode only Code 39 symbols containing a selected length. Select the length using the barcodes in [Numeric Barcodes](#). For example, to decode only Code 39 symbols with 14 characters, scan **Code 39 - One Discrete Length**, and then scan **1, 4**. To correct an error or change the selection, scan [Cancel on page 441](#).
- **Two Discrete Lengths** - Decode only Code 39 symbols containing either of two lengths. Select lengths using the barcodes in [Numeric Barcodes](#). For example, to decode only Code 39 symbols containing either 2 or 14 characters, scan **Code 39 - Two Discrete Lengths**, and then scan **0, 2, 1, 4**. To correct an error or change the selection, scan [Cancel on page 441](#).
- **Length Within Range** - Decode Code 39 symbols with a specific length range. Select lengths using the barcodes in [Numeric Barcodes](#). For example, to decode Code 39 symbols containing between 4 and 12 characters, scan **Code 39 - Length Within Range**, and then scan **0, 4, 1, 2**. To correct an error or change the selection, scan [Cancel on page 441](#).
- **Any Length** - Decode Code 39 symbols containing any number of characters within the scanner's capability.



Code 39 - One Discrete Length



Code 39 - Two Discrete Lengths



* Code 39 - Length Within Range



Code 39 - Any Length

Code 39 Check Digit Verification

Parameter # 48

SSI # 30h

Scan **Enable Code 39 Check Digit** to check the integrity of all Code 39 symbols to verify that the data complies with specified check digit algorithm. Only Code 39 symbols which include a modulo 43 check digit are decoded. Enable this feature if the Code 39 symbols contain a Modulo 43 check digit.

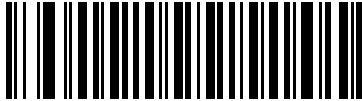

**Enable Code 39 Check Digit
(1)**

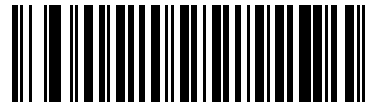

*** Disable Code 39 Check Digit
(0)**

Transmit Code 39 Check Digit

Parameter # 43

SSI # 2Bh

Scan one of the following barcodes to transmit Code 39 data with or without the check digit.



NOTE: [Code 39 Check Digit Verification](#) must be enabled for this parameter to function.

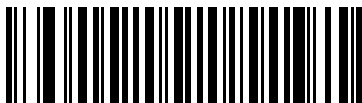

**Transmit Code 39 Check Digit (Enable)
(1)**



*** Do Not Transmit Code 39 Check Digit (Disable)
(0)**

Code 39 Full ASCII Conversion

Parameter # 17

SSI # 11h

Code 39 Full ASCII is a variant of Code 39 which pairs characters to encode the full ASCII character set. Scan one of the following barcodes to enable or disable Code 39 Full ASCII.



NOTE: You cannot enable Trioptic Code 39 and Code 39 Full ASCII simultaneously.

Code 39 Full ASCII to Full ASCII Correlation is host-dependent, and is therefore described in the ASCII character set table for the appropriate interface. See [Table 33 on page 460](#).



**Enable Code 39 Full ASCII
(1)**

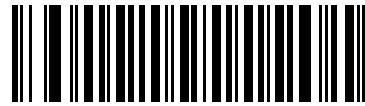

*** Disable Code 39 Full ASCII
(0)**

Code 39 Security Level

Parameter # 750

SSI # F1h EEh

The scanner offers four levels of decode security for Code 39 barcodes. There is an inverse relationship between security and scanner aggressiveness. Increasing the level of security can reduce scanning aggressiveness, so select only the level of security necessary.

- **Code 39 Security Level 0:** The scanner operates in its most aggressive state, while providing sufficient security in decoding most in-spec barcodes.
- **Code 39 Security Level 1:** This default setting eliminates most misdecodes.
- **Code 39 Security Level 2:** This option applies greater barcode security requirements if **Security Level 1** fails to eliminate misdecodes.
- **Code 39 Level 3:** If you selected **Security Level 2**, and misdecodes still occur, select this security level to apply the highest safety requirements.



NOTE: Selecting this option is an extreme measure against mis-decoding severely out-of-spec barcodes, and significantly impairs the decoding ability of the scanner. If this level of security is required, try to improve the quality of the barcodes.

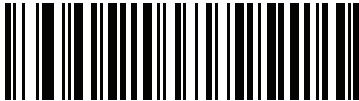

Code 39 Security Level 0
(0)



* Code 39 Security Level 1
(1)



Code 39 Security Level 2
(2)



Code 39 Security Level 3
(3)

Code 39 Reduced Quiet Zone

Parameter # 1209

SSI # F8h 04h B9h

Scan one of the following barcodes to enable or disable decoding Code 39 barcodes with reduced quiet zones (the margins on either side of the barcode). If you select **Enable**, select a [1D Quiet Zone Level on page 205](#).



Enable Code 39 Reduced Quiet Zone
(1)



* Disable Code 39 Reduced Quiet Zone
(0)

Code 93

Parameter # 9

SSI # 09h

Scan one of the following barcodes to enable or disable Code 93.

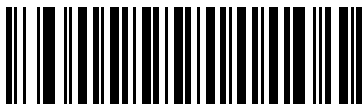

* Enable Code 93
(1)



Disable Code 93
(0)

Set Lengths for Code 93

L1 = Parameter # 26

SSI # 1Ah

L2 = Parameter # 27

SSI # 1Bh

The length of a code refers to the number of characters (i.e., human readable characters), including check digit(s) the code contains. Set lengths for Code 93 to any length, one or two discrete lengths, or lengths within a specific range. The default is **Length Within Range: 1 to 55**.



NOTE: When setting lengths, enter a leading zero for single digit numbers.

Scan one of the following barcodes to select a length option:

- **One Discrete Length** - Decode only Code 93 symbols containing a selected length. Select the length using the barcodes in [Numeric Barcodes](#). For example, to decode only Code 93 symbols with 14 characters, scan **Code 93 - One Discrete Length**, and then scan **1, 4**. To correct an error or change the selection, scan [Cancel on page 441](#).
- **Two Discrete Lengths** - Decode only Code 93 symbols containing either of two lengths. Select lengths using the barcodes in [Numeric Barcodes](#). For example, to decode only Code 93 symbols containing either 2 or 14 characters, scan **Code 93 - Two Discrete Lengths**, and then scan **0, 2, 1, 4**. To correct an error or change the selection, scan [Cancel on page 441](#).
- **Length Within Range** - Decode Code 93 symbols with a specific length range. Select lengths using the barcodes in [Numeric Barcodes](#). For example, to decode Code 93 symbols containing between 4 and 12 characters, scan **Code 93 - Length Within Range**, and then scan **0, 4, 1, 2**. To correct an error or change the selection, scan [Cancel on page 441](#).
- **Any Length** - Decode Code 93 symbols containing any number of characters within the scanner's capability.

Set Lengths for Code 93 (continued)



Code 93 - One Discrete Length



Code 93 - Two Discrete Lengths



*** Code 93 - Length Within Range**



Code 93 - Any Length

Code 11

Parameter # 10

SSI # 0Ah

Scan one of the following barcodes to enable or disable Code 11

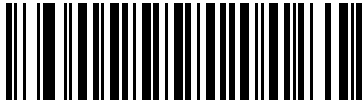

Enable Code 11
(1)

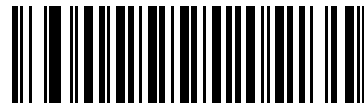

* Disable Code 11
(0)

Set Lengths for Code 11

L1 = Parameter # 28

SSI # 1Ch

L2 = Parameter # 29

SSI # 1Dh

The length of a code refers to the number of characters (i.e., human readable characters), including check digit(s) the code contains. Set lengths for Code 11 to any length, one or two discrete lengths, or lengths within a specific range. The default is **Length Within Range: 4 to 55**.



NOTE: When setting lengths, enter a leading zero for single digit numbers

Scan one of the following barcodes to select a length option:

- **One Discrete Length** - Decode only Code 11 symbols containing a selected length. Select the length using the barcodes in [Numeric Barcodes](#). For example, to decode only Code 11 symbols with 14 characters, scan **Code 11 - One Discrete Length**, and then scan **1, 4**. To correct an error or change the selection, scan [Cancel on page 441](#).
- **Two Discrete Lengths** - Decode only Code 11 symbols containing either of two lengths. Select lengths using the barcodes in [Numeric Barcodes](#). For example, to decode only Code 11 symbols containing either 2 or 14 characters, scan **Code 11 - Two Discrete Lengths**, and then scan **0, 2, 1, 4**. To correct an error or change the selection, scan [Cancel on page 441](#).
- **Length Within Range** - Decode Code 11 symbols with a specific length range. Select lengths using the barcodes in [Numeric Barcodes](#). For example, to decode Code 11 symbols containing between 4 and 12 characters, scan **Code 11 - Length Within Range**, and then scan **0, 4, 1, 2**. To correct an error or change the selection, scan [Cancel on page 441](#).
- **Any Length** - Decode Code 11 symbols containing any number of characters within the scanner's capability.

Set Lengths for Code 11 (continued)



Code 11 - One Discrete Length



Code 11 - Two Discrete Lengths



*** Code 11 - Length Within Range**



Code 11 - Any Length

Code 11 Check Digit Verification

Parameter # 52

SSI # 34h

This feature allows the scanner to check the integrity of all Code 11 symbols to verify that the data complies with the specified check digit algorithm.

Scan one of the following barcodes to specify the number of check digits encoded in the Code 11 symbols, or to disable this feature.

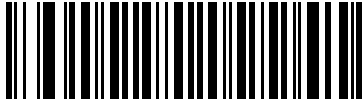

*** Disable
(0)**

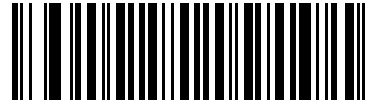

**One Check Digit
(1)**

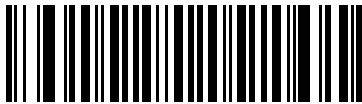

**Two Check Digits
(2)**

Transmit Code 11 Check Digits

Parameter # 47

SSI # 2Fh

Scan one of the following barcodes to select whether or not to transmit the Code 11 check digit(s).



NOTE: [Code 11 Check Digit Verification](#) must be enabled for this parameter to function.

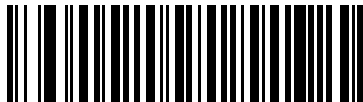

Transmit Code 11 Check Digit(s) (Enable)
(1)

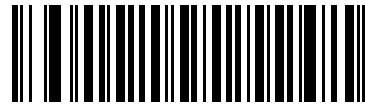

* Do Not Transmit Code 11 Check Digit(s) (Disable)
(0)

Interleaved 2 of 5 (ITF)

Parameter # 6

SSI # 06h

Scan one of the following barcodes to enable or disable Interleaved 2 of 5.

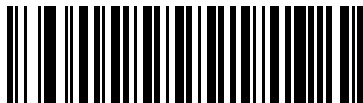

* Enable Interleaved 2 of 5
(1)

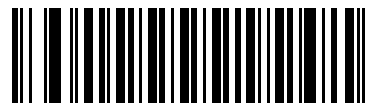

Disable Interleaved 2 of 5
(0)

Set Lengths for Interleaved 2 of 5

L1 = Parameter # 22

SSI # 16h

L2 = Parameter # 23

SSI # 17h

The length of a code refers to the number of characters (i.e., human readable characters), including check digit(s) the code contains. Set lengths for I 2 of 5 to any length, one or two discrete lengths, or lengths within a specific range. The range for Interleaved 2 of 5 lengths is 0 - 80. The default is **Length Within Range**: 6 to 55.



NOTE: When setting lengths, enter a leading zero for single digit numbers.

Scan one of the following barcodes to select a length option:

- **One Discrete Length** - Decode only I 2 of 5 symbols containing a selected length. Select the length using the barcodes in [Numeric Barcodes](#). For example, to decode only I 2 of 5 symbols with 14 characters, scan **I 2 of 5 - One Discrete Length**, and then scan **1, 4**. To correct an error or change the selection, scan [Cancel on page 441](#).
- **Two Discrete Lengths** - Decode only I 2 of 5 symbols containing either of two lengths. Select lengths using the barcodes in [Numeric Barcodes](#). For example, to decode only I 2 of 5 symbols containing either 2 or 14 characters, scan **I 2 of 5 - Two Discrete Lengths**, and then scan **0, 2, 1, 4**. To correct an error or change the selection, scan [Cancel on page 441](#).
- **Length Within Range** - Decode I 2 of 5 symbols with a specific length range. Select lengths using the barcodes in [Numeric Barcodes](#). For example, to decode I 2 of 5 symbols containing between 4 and 12 characters, scan **I 2 of 5 - Length Within Range**, and then scan **0, 4, 1, 2**. To correct an error or change the selection, scan [Cancel on page 441](#).
- **Any Length** - Decode I 2 of 5 symbols containing any number of characters within the scanner's capability.



NOTE: Due to the construction of the I 2 of 5 symbology, it is possible for a scan line covering only a portion of the code to transmit as a complete scan, yielding less data than is encoded in the barcode. To prevent this, select specific lengths (I 2 of 5 - One Discrete Length, Two Discrete Lengths) for I 2 of 5 applications, or increase the [I 2 of 5 Security Level on page 176](#).

Set Lengths for Interleaved 2 of 5 (continued)



I 2 of 5 - One Discrete Length



I 2 of 5 - Two Discrete Lengths



* I 2 of 5 - Length Within Range



I 2 of 5 - Any Length

I 2 of 5 Check Digit Verification

Parameter # 49

SSI # 31h

Scan one of the following barcodes to check the integrity of all I 2 of 5 symbols to verify the data complies with either the specified Uniform Symbology Specification (USS), or the Optical Product Code Council (OPCC) check digit algorithm.



* Disable
(0)



USS Check Digit
(1)



OPCC Check Digit
(2)

Transmit I 2 of 5 Check Digit**Parameter # 44****SSI # 2Ch**

Scan one of the following barcodes to transmit I 2 of 5 data with or without the check digit.



Transmit I 2 of 5 Check Digit (Enable)
(1)

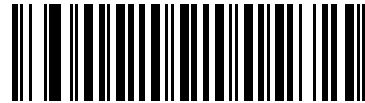

*** Do Not Transmit I 2 of 5 Check Digit (Disable)**
(0)

Convert I 2 of 5 to EAN-13**Parameter # 82****SSI # 52h**

Scan **Convert I 2 of 5 to EAN-13 (Enable)** to convert 14-character I 2 of 5 codes to EAN-13, and transmit to the host as EAN-13. To accomplish this, the I 2 of 5 code must be enabled, and the code must have a leading zero and a valid EAN-13 check digit.



Convert I 2 of 5 to EAN-13 (Enable)
(1)



*** Do Not Convert I 2 of 5 to EAN-13 (Disable)**
(0)

Febraban

Parameter # 1750

SSI # F8h 06h D6h

Febraban is an I 2 of 5 barcode of length 44 that requires special check characters to be inserted in the transmitted data stream. When enabled, the I 2 of 5 internal check digit calculation and transmission is disabled. When disabled, all I 2 of 5 functionality works as usual.

Recommendations for Length Setting

I 2 of 5 Length 1: Larger of the fixed length and the FEBRABAN length (==44).

I 2 of 5 Length 2: Smaller of the fixed length and the FEBRABAN length (==44).



**Enable Febraban
(1)**



*** Disable Febraban
(0)**

I 2 of 5 Security Level

Parameter # 1121

SSI # F8h 04h 61h

Interleaved 2 of 5 barcodes are vulnerable to misdecodes, particularly when I 2 of 5 Lengths is set to **Any Length**. The scanner offers four levels of decode security for Interleaved 2 of 5 barcodes. There is an inverse relationship between security and scanner aggressiveness. Increasing the level of security can reduce scanning aggressiveness, so select only the level of security necessary.

- **I 2 of 5 Security Level 0:** The scanner operates in its most aggressive state, while providing sufficient security in decoding most in-spec barcodes.
- **I 2 of 5 Security Level 1:** A barcode must be successfully read twice, and satisfy certain safety requirements before being decoded. This default setting eliminates most misdecodes.
- **I 2 of 5 Security Level 2:** This option applies greater barcode security requirements if **Security Level 1** fails to eliminate misdecodes.
- **I 2 of 5 Security Level 3:** If you selected **Security Level 2**, and misdecodes still occur, select this security level. The highest safety requirements are applied. A barcode must be successfully read three times before being decoded.



NOTE: Selecting this option is an extreme measure against mis-decoding severely out-of-spec barcodes, and significantly impairs the decoding ability of the scanner. If this level of security is required, try to improve the quality of the barcodes.

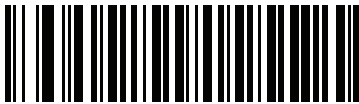

I 2 of 5 Security Level 0
(0)



* I 2 of 5 Security Level 1
(1)

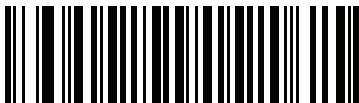

I 2 of 5 Security Level 2
(2)



I 2 of 5 Security Level 3
(3)

I 2 of 5 Reduced Quiet Zone

Parameter # 1210

SSI # F8h 04h BAh

Scan one of the following barcodes to enable or disable decoding I 2 of 5 barcodes with reduced quiet zones (the margins on either side of the barcode). If you select **Enable**, select a [1D Quiet Zone Level on page 205](#).



Enable I 2 of 5 Reduced Quiet Zone
(1)



* Disable I 2 of 5 Reduced Quiet Zone
(0)

Discrete 2 of 5 (DTF)

Parameter # 5

SSI # 05h

Scan one of the following barcodes to enable or disable Discrete 2 of 5.

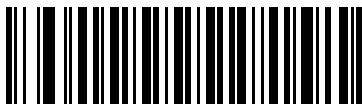

Enable Discrete 2 of 5
(1)

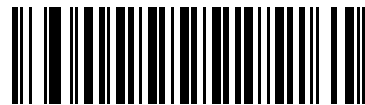

* Disable Discrete 2 of 5
(0)

Set Lengths for Discrete 2 of 5

L1 = Parameter # 20

SSI # 14h

L2 = Parameter # 21

SSI # 15h

The length of a code refers to the number of characters (i.e., human readable characters), including check digit(s) the code contains. Set lengths for D 2 of 5 to any length, one or two discrete lengths, or lengths within a specific range. The default is **Length Within Range: 1 to 55**.



NOTE: When setting lengths, enter a leading zero for single digit numbers.

Scan one of the following barcodes to select a length option:

- **One Discrete Length** - Decode only D 2 of 5 symbols containing a selected length. Select the length using the barcodes in [Numeric Barcodes](#). For example, to decode only D 2 of 5 symbols with 14 characters, scan **D 2 of 5 - One Discrete Length**, and then scan **1, 4**. To correct an error or change the selection, scan [Cancel on page 441](#).
- **Two Discrete Lengths** - Decode only D 2 of 5 symbols containing either of two lengths. Select lengths using the barcodes in [Numeric Barcodes](#). For example, to decode only D 2 of 5 symbols containing either 2 or 14 characters, scan **D 2 of 5 - Two Discrete Lengths**, and then scan **0, 2, 1, 4**. To correct an error or change the selection, scan [Cancel on page 441](#).
- **Length Within Range** - Decode D 2 of 5 symbols with a specific length range. Select lengths using the barcodes in [Numeric Barcodes](#). For example, to decode D 2 of 5 symbols containing between 4 and 12 characters, scan **D 2 of 5 - Length Within Range**, and then scan **0, 4, 1, 2**. To correct an error or change the selection, scan [Cancel on page 441](#).
- **Any Length** - Decode D 2 of 5 symbols containing any number of characters within the scanner's capability.

Set Lengths for Discrete 2 of 5 (continued)



NOTE: Due to the construction of the D 2 of 5 symbology, it is possible for a scan line covering only a portion of the code to transmit as a complete scan, yielding less data than is encoded in the barcode. To prevent this, select specific lengths (D 2 of 5 - One Discrete Length, Two Discrete Lengths) for D 2 of 5 applications.



D 2 of 5 - One Discrete Length



D 2 of 5 - Two Discrete Lengths



*** D 2 of 5 - Length Within Range**



D 2 of 5 - Any Length

Codabar (NW - 7)

Parameter # 7

SSI # 07h

Scan one of the following barcodes to enable or disable Codabar.

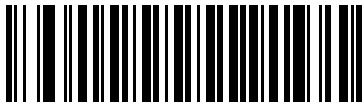

* Enable Codabar
(1)

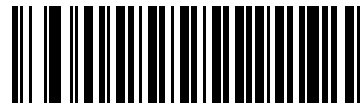

Disable Codabar
(0)

Set Lengths for Codabar

L1 = Parameter # 24

SSI # 18h

L2 = Parameter # 25

SSI # 19h

The length of a code refers to the number of characters (i.e., human readable characters), including check digit(s) the code contains. Set lengths for Codabar to any length, one or two discrete lengths, or lengths within a specific range. The default is **Length Within Range: 4 to 55**.



NOTE: When setting lengths, enter a leading zero for single digit numbers.

Scan one of the following barcodes to select a length option:

- **One Discrete Length** - Decode only Codabar symbols containing a selected length. Select the length using the barcodes in [Numeric Barcodes](#). For example, to decode only Codabar symbols with 14 characters, scan **Codabar - One Discrete Length**, and then scan **1, 4**. To correct an error or change the selection, scan [Cancel on page 441](#).
- **Two Discrete Lengths** - Decode only Codabar symbols containing either of two lengths. Select lengths using the barcodes in [Numeric Barcodes](#). For example, to decode only Codabar symbols containing either 2 or 14 characters, scan **Codabar - Two Discrete Lengths**, and then scan **0, 2, 1, 4**. To correct an error or change the selection, scan [Cancel on page 441](#).
- **Length Within Range** - Decode Codabar symbols with a specific length range. Select lengths using the barcodes in [Numeric Barcodes](#). For example, to decode Codabar symbols containing between 4 and 12 characters, scan **Codabar - Length Within Range**, and then scan **0, 4, 1, 2**. To correct an error or change the selection, scan [Cancel on page 441](#).
- **Any Length** - Decode Codabar symbols containing any number of characters within the scanner's capability.

Set Lengths for Codabar (continued)



Codabar - One Discrete Length



Codabar - Two Discrete Lengths



*** Codabar - Length Within Range**



Codabar - Any Length

CLSI Editing

Parameter # 54

SSI # 36h

Scan **Enable CLSI Editing** to strip the start and stop characters and insert a space after the first, fifth, and tenth characters of a 14-character Codabar symbol if the host system requires this data format.



NOTE: Symbol length does not include start and stop characters.

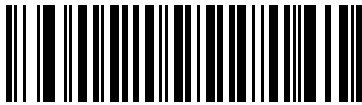

**Enable CLSI Editing
(1)**

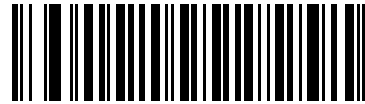

*** Disable CLSI Editing
(0)**

NOTIS Editing

Parameter # 55

SSI # 37h

Scan **Enable NOTIS Editing** to strip the start and stop characters from a decoded Codabar symbol if the host system requires this data format.

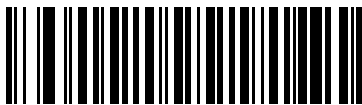

**Enable NOTIS Editing
(1)**



*** Disable NOTIS Editing
(0)**

Codabar Security Level

Parameter # 1776

SSI # F8h 06h F0h

The scanner offers four levels of decode security for Codabar barcodes. There is an inverse relationship between security and scanner aggressiveness. Increasing the level of security can reduce scanning aggressiveness, so select only the level of security necessary.

- **Codabar Security Level 0:** This setting allows the scanner to operate in its most aggressive state, while providing sufficient security in decoding most in-spec barcodes.
- **Codabar Security Level 1:** This default setting eliminates most misdecodes.
- **Codabar Security Level 2:** Select this option with greater barcode security requirements if **Security Level 1** fails to eliminate misdecodes.
- **Codabar Security Level 3:** If you selected **Security Level 2**, and misdecodes still occur, select this security level to apply the highest safety requirements.



NOTE: Selecting this option is an extreme measure against mis-decoding severely out-of-spec barcodes, and significantly impairs the decoding ability of the scanner. If this level of security is required, try to improve the quality of the barcodes.



Codabar Security Level 0
(0)

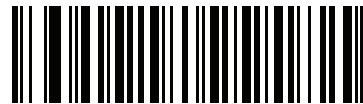

* **Codabar Security Level 1**
(1)

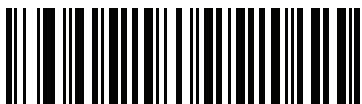

Codabar Security Level 2
(2)



Codabar Security Level 3
(3)

Codabar Upper or Lower Case Start/Stop Characters

Parameter # 855

SSI # F2h 57h

Scan one of the following barcodes to select whether to transmit upper case or lower case Codabar start/stop characters.

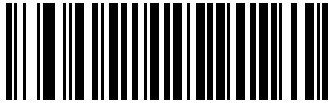

**Lower Case
(1)**

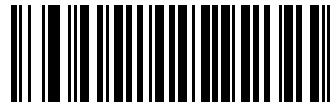

*** Upper Case
(0)**

Codabar Mod 16 Check Digit Verification

Parameter # 1784

SSI # F8h 06h F8h

Enable this feature to check the Codabar Mod 16 Check Digit to verify that the data complies with the specified check digit algorithm.



**Enable Codabar Mod 16 Check Digit
(1)**



*** Disable Codabar Mod 16 Check Digit
(0)**

Transmit Codabar Check Digit

Parameter # 704

SSI # F1h C0h

Scan one of the following barcodes to select whether or not to transmit the Codabar check digit(s).



NOTE: [Codabar Mod 16 Check Digit Verification](#) must be enabled for this parameter to function.



Enable Codabar Check Digit Transmission
(1)



* Disable Codabar Check Digit Transmission
(0)

MSI

Parameter # 11

SSI # 0Bh

Scan one of the following barcodes to enable or disable MSI.

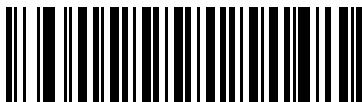

Enable MSI
(1)



* Disable MSI
(0)

Set Lengths for MSI

L1 = Parameter # 30

SSI # 1Eh

L2 = Parameter # 31

SSI # 1Fh

The length of a code refers to the number of characters (i.e., human readable characters), including check digit(s) the code contains. Set lengths for MSI to any length, one or two discrete lengths, or lengths within a specific range. The default is **Length Within Range: 4 to 55**.



NOTE: When setting lengths, enter a leading zero for single digit numbers.

Scan one of the following barcodes to select a length option:

- **One Discrete Length** - Decode only MSI symbols containing a selected length. Select the length using the barcodes in [Numeric Barcodes](#). For example, to decode only MSI symbols with 14 characters, scan **MSI - One Discrete Length**, and then scan **1, 4**. To correct an error or change the selection, scan [Cancel on page 441](#).
- **Two Discrete Lengths** - Decode only MSI symbols containing either of two lengths. Select lengths using the barcodes in [Numeric Barcodes](#). For example, to decode only MSI symbols containing either 2 or 14 characters, scan **MSI - Two Discrete Lengths**, and then scan **0, 2, 1, 4**. To correct an error or change the selection, scan [Cancel on page 441](#).
- **Length Within Range** - Decode MSI symbols with a specific length range. Select lengths using the barcodes in [Numeric Barcodes](#). For example, to decode MSI symbols containing between 4 and 12 characters, scan **MSI - Length Within Range**, and then scan **0, 4, 1, 2**. To correct an error or change the selection, scan [Cancel on page 441](#).
- **Any Length** - Decode MSI symbols containing any number of characters within the scanner's capability.

Set Lengths for MSI (continued)



NOTE: Due to the construction of the MSI symbology, it is possible for a scan line covering only a portion of the code to transmit as a complete scan, yielding less data than is encoded in the barcode. To prevent this, select specific lengths (**MSI - One Discrete Length, Two Discrete Lengths**) for MSI applications.



MSI - One Discrete Length



MSI - Two Discrete Lengths



*** MSI - Length Within Range**



MSI - Any Length

MSI Check Digits

Parameter # 50

SSI # 32h

With MSI symbols, one check digit is mandatory and always verified by the reader. The second check digit is optional. If the MSI codes include two check digits, scan the **Two MSI Check Digits** barcode to enable verification of the second check digit.

See [MSI Check Digit Algorithm on page 190](#) to select second digit algorithms.



No MSI Check Digit
(0)



* One MSI Check Digit
(1)



Two MSI Check Digits
(2)

Transmit MSI Check Digit(s)

Parameter # 46

SSI # 2Eh

Scan one of the following barcodes to transmit MSI data with or without the check digit.

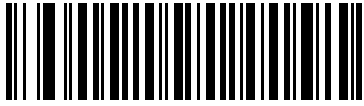

Transmit MSI Check Digit(s) (Enable)
(1)

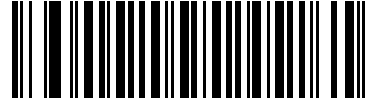

*** Do Not Transmit MSI Check Digit(s) (Disable)**
(0)

MSI Check Digit Algorithm

Parameter # 51

SSI # 33h

Two algorithms are available for verifying the second MSI check digit. Scan one of the following barcodes to select the algorithm used to encode the check digit.

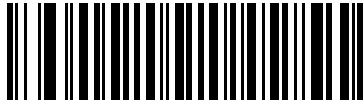

MOD 11/MOD 10
(0)



* MOD 10/MOD 10
(1)

MSI Reduced Quiet Zone

Parameter # 1392

SSI # F8h 05h 70h

Scan one of the following barcodes to enable or disable decoding MSI barcodes with reduced quiet zones. If you select **Enable**, select a [1D Quiet Zone Level on page 205](#).

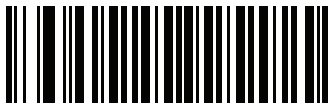

* Disable MSI Reduced Quiet Zone
(0)



Enable MSI Reduced Quiet Zone
(1)

Chinese 2 of 5

Parameter # 408

SSI # F0h 98h

Scan one of the following barcodes to enable or disable Chinese 2 of 5.



**Enable Chinese 2 of 5
(1)**

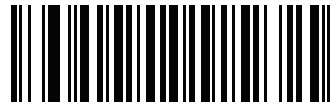

*** Disable Chinese 2 of 5
(0)**

Matrix 2 of 5

Parameter # 618

SSI # F1h 6Ah

Scan one of the following barcodes to enable or disable Matrix 2 of 5.



**Enable Matrix 2 of 5
(1)**



*** Disable Matrix 2 of 5
(0)**

Set Lengths for Matrix 2 of 5

L1 = Parameter # 619

SSI # F1h 6Bh

L2 = Parameter # 620

SSI # F1h 6Ch

The length of a code refers to the number of characters (i.e., human readable characters), including check digit(s) the code contains. Set lengths for Matrix 2 of 5 to any length, one or two discrete lengths, or lengths within a specific range. The default is **Length Within Range: 4 to 55**.



NOTE: When setting lengths, enter a leading zero for single digit numbers.

Scan one of the following barcodes to select a length option:

- **One Discrete Length** - Decode only Matrix 2 of 5 symbols containing a selected length. Select the length using the barcodes in [Numeric Barcodes](#). For example, to decode only Matrix 2 of 5 symbols with 14 characters, scan **Matrix 2 of 5 - One Discrete Length**, and then scan **1, 4**. To correct an error or change the selection, scan [Cancel on page 441](#).
- **Two Discrete Lengths** - Decode only Matrix 2 of 5 symbols containing either of two lengths. Select lengths using the barcodes in [Numeric Barcodes](#). For example, to decode only Matrix 2 of 5 symbols containing either 2 or 14 characters, scan **Matrix 2 of 5 - Two Discrete Lengths**, and then scan **0, 2, 1, 4**. To correct an error or change the selection, scan [Cancel on page 441](#).
- **Length Within Range** - Decode Matrix 2 of 5 symbols with a specific length range. Select lengths using the barcodes in [Numeric Barcodes](#). For example, to decode Matrix 2 of 5 symbols containing between 4 and 12 characters, scan **Matrix 2 of 5 - Length Within Range**, and then scan **0, 4, 1, 2**. To correct an error or change the selection, scan [Cancel on page 441](#).
- **Any Length** - Decode Matrix 2 of 5 symbols containing any number of characters within the scanner's capability.

Set Lengths for Matrix 2 of 5 (continued)



Matrix 2 of 5 - One Discrete Length



Matrix 2 of 5 - Two Discrete Lengths



*** Matrix 2 of 5 - Length Within Range**



Matrix 2 of 5 - Any Length

Matrix 2 of 5 Check Digit**Parameter # 622****SSI # F1h 6Eh**

The check digit is the last character of the symbol used to verify the integrity of the data. Scan one of the following barcodes to determine whether to include the Matrix 2 of 5 check digit with the barcode data.



**Enable Matrix 2 of 5 Check Digit
(1)**



*** Disable Matrix 2 of 5 Check Digit
(0)**

Transmit Matrix 2 of 5 Check Digit**Parameter # 623****SSI # F1h 6Fh**

Scan one of the following barcodes to transmit Matrix 2 of 5 data with or without the check digit.



**Transmit Matrix 2 of 5 Check Digit
(1)**



*** Do Not Transmit Matrix 2 of 5 Check Digit
(0)**

Korean 3 of 5

Parameter # 581

SSI # F1h 45h

Scan one of the following barcodes to enable or disable Korean 3 of 5.



NOTE: The length for Korean 3 of 5 is fixed at 6.



**Enable Korean 3 of 5
(1)**



*** Disable Korean 3 of 5
(0)**

Inverse 1D

Parameter # 586

SSI # F1h 4Ah



NOTE: The Inverse 1D setting may impact Composite or Inverse Composite decoding. See [Composite Inverse on page 207](#).

Scan one of the following barcodes to set the 1D inverse decoder setting:

- **Regular Only** - The scanner decodes regular 1D barcodes only.
- **Inverse Only** - The scanner decodes inverse 1D barcodes only.
- **Inverse Autodetect** - The scanner decodes both regular and inverse 1D barcodes.

Inverse 1D (continued)



*** Regular
(0)**



**Inverse Only
(1)**



**Inverse Autodetect
(2)**

GS1 DataBar

The variants of GS1 DataBar are GS1 DataBar Omnidirectional, GS1 DataBar Truncated, GS1 DataBar Stacked, GS1 DataBar Stacked Omnidirectional, DataBar Expanded, GS1 DataBar Expanded Stacked and DataBar Limited. The limited and expanded versions have stacked variants. Scan the appropriate barcodes to enable or disable each variant of GS1 DataBar.

GS1 DataBar Omnidirectional (formerly GS1 DataBar-14), GS1 DataBar Truncated, GS1 DataBar Stacked, GS1 DataBar Stacked Omnidirectional

Parameter # 338

SSI # F0h 52h



NOTE: When GS1 DataBar Omnidirectional is enabled the variants are also enabled.

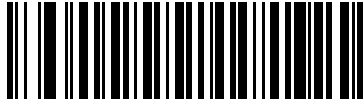

* Enable GS1 DataBar Omnidirectional
(1)

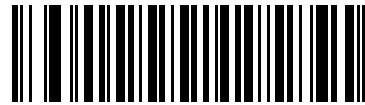

Disable GS1 DataBar Omnidirectional
(0)

GS1 DataBar Limited

Parameter # 339

SSI # F0h 53h

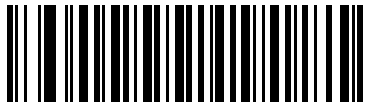

* Enable GS1 DataBar Limited
(1)

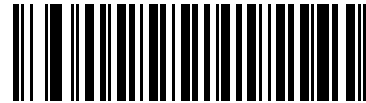

Disable GS1 DataBar Limited
(0)

GS1 DataBar Expanded, GS1 DataBar Expanded Stacked

Parameter # 340

SSI # F0h 54h



NOTE: When GS1 DataBar Expanded is enabled GS1 DataBar Expanded Stacked is also enabled.

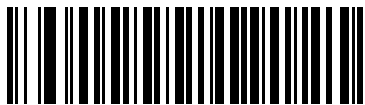

* Enable GS1 DataBar Expanded
(1)



Disable GS1 DataBar Expanded
(0)

Convert GS1 DataBar to UPC/EAN/JAN

Parameter # 397

SSI # F0h, 8Dh

This parameter only applies to GS1 DataBar Omnidirectional and GS1 DataBar Limited symbols not decoded as part of a Composite symbol. Scan **Enable Convert GS1 DataBar to UPC/EAN/JAN** to strip the leading '010' from DataBar-14 and DataBar Limited symbols encoding a single zero as the first digit, and report the barcode as EAN-13.

For barcodes beginning with between two and five zeros, this strips the leading '0100' and reports the barcode as UPC-A. The [UPC-A Preamble](#) option that transmits the system character and country code applies to converted barcodes. Note that neither the system character nor the check digit can be stripped.

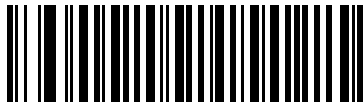

Enable Convert GS1 DataBar to UPC/EAN/JAN
(1)

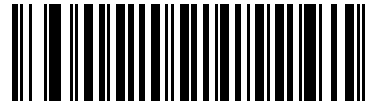

*** Disable Convert GS1 DataBar to UPC/EAN/JAN**
(0)

GS1 DataBar Security Level

Parameter # 1706

SSI # F8h 06h AAh

The scanner offers four levels of decode security for GS1 DataBar (GS1 DataBar Omnidirectional, GS1 DataBar Limited, GS1 DataBar Expanded) barcodes.

- **Security Level 0** - The scanner operates in its most aggressive state, while providing sufficient security decoding most in-spec barcodes.
- **Security Level 1** - This setting eliminates most misdecodes while maintaining reasonable aggressiveness.
- **Security Level 2** - Select this option with greater barcode security requirements if Security Level 1 fails to eliminate misdecodes.
- **Security Level 3** - If you selected Security Level 2 and misdecodes still occur, select this security level to apply the highest safety requirements.



GS1 DataBar Security Level 0
(0)



* GS1 DataBar Security Level 1
(1)



GS1 DataBar Security Level 2
(2)



GS1 DataBar Security Level 3
(3)

GS1 DataBar Limited Margin Check

Parameter # 728

SSI # F1h D8h

The scanner offers four levels of decode security for GS1 DataBar Limited barcodes. There is an inverse relationship between the level of margin check and scanner aggressiveness. Increasing the level of margin check can reduce scanning aggressiveness, so select only the level of margin check necessary.

- **Margin Check Level 1** – No clear margin required. This complies with the original GS1 standard, yet can result in erroneous decoding of a DataBar Limited barcode when scanning some UPC symbols that start with digits **9** and **7**.
- **Margin Check Level 2** – Automatic risk detection. This level of margin check can result in erroneous decoding of DataBar Limited barcodes when scanning some UPC symbols. If a misdecode is detected, the scanner operates in Level 3 or Level 1.
- **Margin Check Level 3** – Margin check level reflects the newly proposed GS1 standard that requires a five times trailing clear margin.
- **Margin Check Level 4** – Security level extends beyond the standard required by GS1. This level of margin check requires a five times leading and trailing clear margin.



GS1 DataBar Limited Margin Check Level 1
(1)



GS1 DataBar Limited Margin Check Level 2
(2)

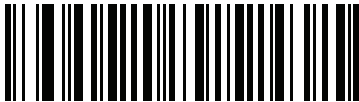

* GS1 DataBar Limited Margin Check Level 3
(3)



GS1 DataBar Limited Margin Check Level 4
(4)

Symbology-Specific Security Features

Redundancy Level

Parameter # 78

SSI # 4Eh

The scanner offers four levels of decode redundancy. Select higher redundancy levels for decreasing levels of barcode quality. As redundancy levels increase, the scanner's aggressiveness decreases.

Scan one of the following barcodes to select the redundancy level appropriate for the barcode quality:

- **Redundancy Level 1** - The scanner must read the following code types twice before decoding:
 - Codabar (8 characters or less)
 - MSI (4 characters or less)
 - D 2 of 5 (8 characters or less)
 - I 2 of 5 (8 characters or less)
- **Redundancy Level 2** - The scanner must read all code types twice before decoding.
- **Redundancy Level 3** - The scanner must read code types other than the following twice before decoding, but must read the following codes three times:
 - Codabar (8 characters or less)
 - MSI (4 characters or less)
 - D 2 of 5 (8 characters or less)
 - I 2 of 5 (8 characters or less)
- **Redundancy Level 4** - The scanner must read all code types three times before decoding.

Redundancy Level (continued)



* Redundancy Level 1
(1)

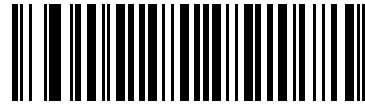

Redundancy Level 2
(2)



Redundancy Level 3
(3)

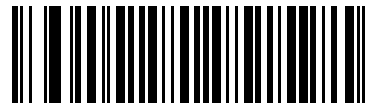

Redundancy Level 4
(4)

Security Level

Parameter # 77

SSI # 4Dh

The scanner offers four levels of decode security for delta barcodes, which include the Code 128 family, UPC/EAN/JAN, and Code 93. Select increasing levels of security for decreasing levels of barcode quality. There is an inverse relationship between security and scanner aggressiveness, so choose only that level of security necessary for the application.

- **Security Level 0** - The scanner operates in its most aggressive state, while providing sufficient security decoding most in-spec barcodes.
- **Security Level 1** - This default setting eliminates most misdecodes.
- **Security Level 2** - Select this option if Security Level 1 fails to eliminate misdecodes.
- **Security Level 3** - If you selected Security Level 2 and misdecodes still occur, select this security level.



NOTE: Selecting this option is an extreme measure against mis-decoding severely out-of-spec barcodes, and significantly impairs the decoding ability of the scanner. If this level of security is required, try to improve the quality of the barcodes.

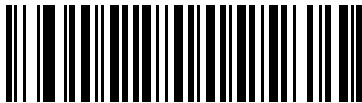

**Security Level 0
(0)**



*** Security Level 1
(1)**

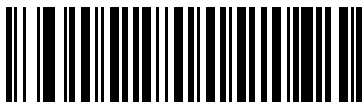

**Security Level 2
(2)**



**Security Level 3
(3)**

1D Quiet Zone Level

Parameter # 1288

SSI # F8h 05h 08h

This feature sets the level of aggressiveness when decoding barcodes with a reduced quiet zone (the margin on either side of a barcode), and applies to symbologies enabled by a Reduced Quiet Zone parameter. Because higher levels increase the decoding time and risk of misdecodes, Zebra strongly recommends enabling only the symbologies which require higher quiet zone levels, and leaving Reduced Quiet Zone disabled for all other symbologies. Options are:

- **1D Quiet Zone Level 0** - The scanner performs normally in terms of quiet zone.
- **1D Quiet Zone Level 1** - The scanner performs more aggressively in terms of quiet zone.
- **1D Quiet Zone Level 2** - The scanner only requires a quiet zone at the end of barcode for decoding.
- **1D Quiet Zone Level 3** - The scanner decodes anything in terms of quiet zone or end of barcode.

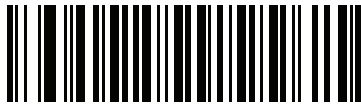

1D Quiet Zone Level 0
(0)

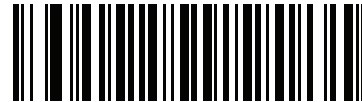

* 1D Quiet Zone Level 1
(1)

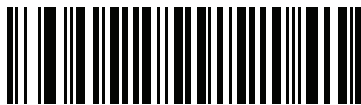

1D Quiet Zone Level 2
(2)



1D Quiet Zone Level 3
(3)

Intercharacter Gap Size

Parameter # 381

SSI # F0h, 7Dh

The Code 39 and Codabar symbologies have an intercharacter gap that is ly quite small. Due to various barcode printing technologies, this gap can grow larger than the maximum size allowed, preventing the scanner from decoding the symbol. If this problem occurs, scan the **Large Intercharacter Gaps** parameter to tolerate these out-of-specification barcodes.



* Normal Intercharacter Gaps
(6)



Large Intercharacter Gaps
(10)

Composite

Composite CC-C

Parameter # 341

SSI # F0h 55h

Scan one of the following barcodes to enable or disable Composite barcodes of type CC-C.

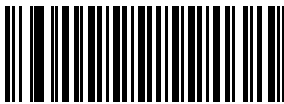

Enable CC-C
(1)



* Disable CC-C
(0)

Composite CC-A/B**Parameter # 342****SSI # F0h 56h**

Scan one of the following barcodes to enable or disable Composite barcodes of type CC-A/B.



**Enable CC-A/B
(1)**

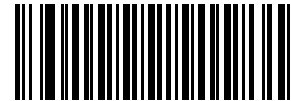

*** Disable CC-A/B
(0)**

Composite TLC-39**Parameter # 371****SSI # F0h 73h**

Scan one of the following barcodes to enable or disable Composite barcodes of type TLC-39.

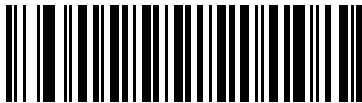

**Enable TLC39
(1)**



*** Disable TLC39
(0)**

Composite Inverse**Parameter # 1113****SSI # F8h 04h 59h**

Select an option to set Composite for either regular decode or inverse decode. This mode only supports Composite Inverse that includes DataBar combined with CCAB, and does not support other 1D/2D combinations.

For this parameter to function, first enable [Composite CC-A/B on page 207](#).

- **Regular Only** - The scanner decodes regular Composite barcodes only. Before selecting this, set [Inverse 1D on page 195](#) to **Regular Only** or **Inverse Autodetect**.
- **Inverse Only** - The scanner decodes inverse Composite barcodes only. Before selecting this, set [Inverse 1D on page 195](#) to **Inverse Only** or **Inverse Autodetect**.



* **Regular Only**
(0)

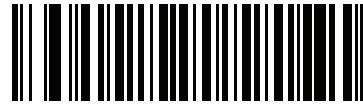

Inverse Only
(1)

UPC Composite Mode

Parameter # 344

SSI # F0h 58h

Select an option for linking UPC symbols with a 2D symbol during transmission as if they were one symbol:

- **UPC Never Linked** - Transmit UPC barcodes regardless of whether a 2D symbol is detected.
- **UPC Always Linked** - Transmit UPC barcodes and the 2D portion. If 2D is not present, do not transmit the barcode.
- **Autodiscriminate UPC Composites** - The scanner determines if there is a 2D portion, then transmits the UPC, as well as the 2D portion if present.

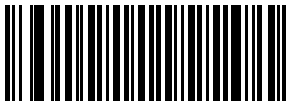

* **UPC Never Linked**
(0)

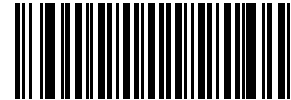

UPC Always Linked
(1)



Autodiscriminate UPC Composites
(2)

Composite Beep Mode

Parameter # 398

SSI # F0h, 8Eh

Scan one of the following barcodes to select the number of decode beeps that sound upon decoding a Composite barcode.

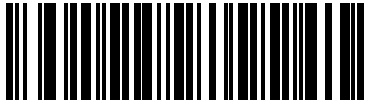

Single Beep After Both are Decoded
(0)

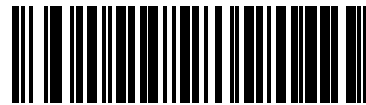

* Beep as Each Code Type is Decoded
(1)

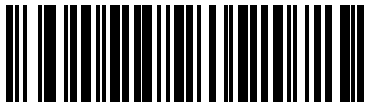

Double Beep After Both are Decoded
(2)

GS1-128 Emulation Mode for UCC/EAN Composite Codes

Parameter # 427

SSI # F0h, ABh

Scan one of the following barcodes to enable or disable this mode.



Enable GS1-128 Emulation Mode for
UCC/EAN Composite Codes
(1)



* Disable GS1-128 Emulation Mode for
UCC/EAN Composite Codes
(0)

2D Symbologies

PDF417

Parameter # 15

SSI # 0Fh

Scan one of the following barcodes to enable or disable PDF417.



* Enable PDF417
(1)



Disable PDF417
(0)

MicroPDF417

Parameter # 227

SSI # E3h

Scan one of the following barcodes to enable or disable MicroPDF417.



Enable MicroPDF417
(1)



* Disable MicroPDF417
(0)

Code 128 Emulation

Parameter # 123

SSI # 7Bh

Enable this parameter to transmit data from certain MicroPDF417 symbols as Code 128. You must enable [AIM Code ID Character \(1\)](#) on page 89 for this parameter to work.



NOTE: Linked MicroPDF codewords 906, 907, 912, 914, and 915 are not supported. Use GS1 Composites instead.

Enable Code 128 Emulation to transmit these MicroPDF417 symbols with one of the following prefixes:

]C1 if the first codeword is 903-905

]C2 if the first codeword is 908 or 909

]C0 if the first codeword is 910 or 911

Disable Code 128 Emulation to transmit these MicroPDF417 symbols with one of the following prefixes:

]L3 if the first codeword is 903-905

]L4 if the first codeword is 908 or 909

]L5 if the first codeword is 910 or 911

Scan one of the following barcodes to enable or disable Code 128 Emulation.



**Enable Code 128 Emulation
(1)**



*** Disable Code 128 Emulation
(0)**

Data Matrix

Parameter # 292

SSI # F0h, 24h

Scan one of the following barcodes to enable or disable Data Matrix.



* Enable Data Matrix
(1)



Disable Data Matrix
(0)

GS1 Data Matrix

Parameter # 1336

SSI # F8h 05h 38h

Scan one of the following barcodes to enable or disable GS1 Data Matrix.



Enable GS1 Data Matrix
(1)

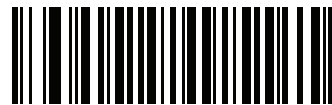

* Disable GS1 Data Matrix
(0)

Data Matrix Inverse

Parameter # 588

SSI # F1h 4Ch

Scan one of the following barcodes to select the Data Matrix inverse decoder setting:

- **Regular Only** - The scanner decodes regular Data Matrix barcodes only.
- **Inverse Only** - The scanner decodes inverse Data Matrix barcodes only.
- **Inverse Autodetect** - The scanner decodes both regular and inverse Data Matrix barcodes.



Regular Only
(0)



Inverse Only
(1)



*** Inverse Autodetect**
(2)

Decode Data Matrix Mirror Images

Parameter # 537

SSI # F1h 19h

Scan one of the following barcodes to select an option for decoding mirror image Data Matrix barcodes:

- **Never** - Do not decode Data Matrix barcodes that are mirror images.
- **Always** - Decode only Data Matrix barcodes that are mirror images.
- **Auto** - Decode both mirrored and unmirrored Data Matrix barcodes.



Never
(0)



Always
(1)



*** Auto**
(2)

Maxicode

Parameter # 294

SSI # F0h, 26h

Scan one of the following barcodes to enable or disable Maxicode.



**Enable Maxicode
(1)**



*** Disable Maxicode
(0)**

QR Code

Parameter # 293

SSI # F0h, 25h

Scan one of the following barcodes to enable or disable QR Code.



NOTE: Inverse QR barcodes decode if QR Code is enabled.



*** Enable QR Code
(1)**



**Disable QR Code
(0)**

Weblink QR

Parameter #1947

SSI # F7 07 9B

Enable or disable Weblink QR bar code.

Options:

- *Enable Weblink QR Codes
- Disable Weblink QR Codes.



***Enable Weblink QR Codes
(1)**



**Disable Weblink QR Codes
(0)**

GS1 QR

Parameter # 1343

SSI # F8h 05h 3Fh

Scan one of the following barcodes to enable or disable GS1 QR.

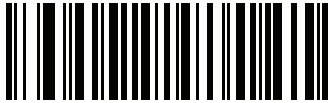

* Enable GS1 QR
(1)



Disable GS1 QR
(0)

MicroQR

Parameter # 573

SSI # F1h 3Dh

Scan one of the following barcodes to enable or disable MicroQR.



* Enable MicroQR
(1)



Disable MicroQR
(0)

Linked QR Mode

Parameter # 1847

SSI # 737h

Scan one of the following barcodes to select a linked QR mode.

- **Linked QR Only** - Does not decode individual QRs from a set of linked QR codes.
- **Individual QR With Headers** - Decodes individual QRs from a set of linked QR codes and keeps the header information and data.
- **Individual QR No Headers** - Decodes individual QRs from a set of linked QR codes and just transmits data without header information.



* **Linked QR Only**
(0)



Individual QR With Headers
(1)



Individual QR No Headers
(2)

Aztec

Parameter # 574

SSI # F1h 3Eh

Scan one of the following barcodes to enable or disable Aztec.



NOTE: Enabling Aztec also enables Linked Aztec.



*** Enable Aztec
(1)**



**Disable Aztec
(0)**

Aztec Inverse

Parameter # 589

SSI # F1h 4Dh

Scan one of the following barcodes to select the Aztec inverse decoder setting:

- **Regular Only** - The scanner decodes regular Aztec barcodes only.
- **Inverse Only** - The scanner decodes inverse Aztec barcodes only.
- **Inverse Autodetect** - The scanner decodes both regular and inverse Aztec barcodes.



**Regular Only
(0)**



**Inverse Only
(1)**



*** Inverse Autodetect
(2)**

Han Xin

Parameter # 1167

SSI # F8h 04h 8Fh

Scan one of the following barcodes to enable or disable Han Xin.



**Enable Han Xin
(1)**



*** Disable Han Xin
(0)**

Han Xin Inverse

Parameter # 1168

SSI # F8h 04h 90h

Scan one of the following barcodes to select a Han Xin inverse decoder setting:

- **Regular Only** - The scanner decodes Han Xin barcodes with normal reflectance only.
- **Inverse Only** - The scanner decodes Han Xin barcodes with inverse reflectance only.
- **Inverse Autodetect** - The scanner decodes both regular and inverse Han Xin barcodes.

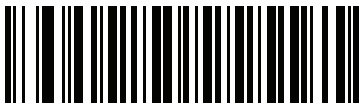

*** Regular Only
(0)**

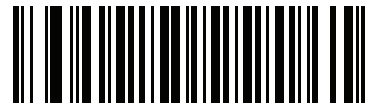

**Inverse Only
(1)**



**Inverse Autodetect
(2)**

Grid Matrix**Parameter # 1718****SSI # F8h 06h B6h**

Scan one of the following barcodes to enable or disable Grid Matrix.



Enable
(1)

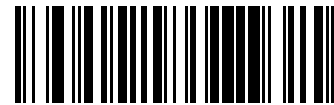

*** Disable**
(0)

Grid Matrix Inverse**Parameter # 1719****SSI # F8h 06h B7h**

Scan one of the following barcodes to select a Grid Matrix inverse decoder setting:

- **Regular Only** - The scanner decodes regular Grid Matrix barcodes only.
- **Inverse Only** - The scanner decodes inverse Grid Matrix barcodes only.
- **Autodiscriminate** - The scanner decodes both regular and inverse Grid Matrix barcodes.



*** Regular Only**
(0)



Inverse Only
(1)



Autodiscriminate
(2)

Grid Matrix Mirror

Parameter # 1736

SSI # F8h 06h C8h

Scan one of the following barcodes to select a Grid Matrix mirror decoder setting:

- **Regular Only** - The scanner decodes regular Grid Matrix barcodes only.
- **Mirrored Only** - The scanner decodes mirrored Grid Matrix barcodes only.
- **Auto-discriminate** - The scanner decodes both regular and mirrored Grid Matrix barcodes.



* **Regular Only**
(0)



Mirrored Only
(1)



Autodiscriminate
(2)

DotCode

Parameter # 1906

SSI # F8 07 72h

Scan one of the following barcodes to enable or disable DotCode.



*** Disable DotCode
(0)**



**Enable DotCode
(1)**

DotCode Inverse

Parameter # 1907

SSI # F8 07 73h

Scan one of the following barcodes to select a DotCode Inverse decoder setting. Setting options are:

- **Regular Only** - Decoder decodes DotCode barcodes with normal reflectance only.
- **Inverse Only** - Decoder decodes DotCode barcodes with inverse reflectance only.
- **Inverse Autodetect** - Decoder decodes both regular and inverse DotCode barcodes.



Regular
(0)



Inverse Only
(1)



*** Inverse Autodetect**
(2)

DotCode Mirrored

Parameter # 1908

SSI # F8 07 74h

Scan one of the following barcodes to select a DotCode Mirror decoder setting:

- **Non-Mirrored Only** - Digital scanner decodes non-mirrored DotCode barcodes only.
- **Mirrored Only** - Digital scanner decodes mirrored DotCode barcodes only.
- **Autodetect** - Digital scanner decodes both mirrored and non-mirrored DotCode barcodes.



Never
(0)



Always
(1)



* Autodetect
(2)

DotCode Prioritize

Parameter # 1937

SSI # F8 07 91h

Enable DotCode Prioritize to give priority to DotCode decoding as compared to other symbologies.

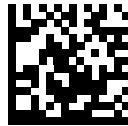

Disable
(0)



*** Enable**
(1)

Macro PDF Features

Macro PDF is a special feature for concatenating multiple PDF symbols into one file. The scanner can decode symbols encoded with this feature, and can store more than 64 Kb of decoded data from up to 50 MacroPDF symbols.



CAUTION: When printing, keep each Macro PDF sequence separate, as each sequence has unique identifiers. Do not mix barcodes from several Macro PDF sequences, even if they encode the same data. When scanning a Macro PDF sequence, scan the entire sequence without interruption. When scanning a mixed sequence, two long low beeps (low / low) indicate an inconsistent file ID or inconsistent symbology error.

Flush Macro Buffer

Scan the following barcode to flush the buffer of all decoded Macro PDF data stored to that point, transmit it to the host device, and abort from Macro PDF mode.



Flush Macro PDF Buffer

Abort Macro PDF Entry

Scan the following barcode to clear all currently-stored Macro PDF data in the buffer without transmission and abort from Macro PDF mode.



Abort Macro PDF Entry

Postal Codes

US Postnet

Parameter # 89

SSI # 59h

Scan one of the following barcodes to enable or disable US Postnet.



**Enable US Postnet
(1)**



*** Disable US Postnet
(0)**

US Planet

Parameter # 90

SSI # 5Ah

Scan one of the following barcodes to enable or disable US Planet.



**Enable US Planet
(1)**

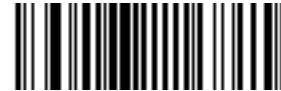

*** Disable US Planet
(0)**

Transmit US Postal Check Digit

Parameter # 95

SSI # 5Fh

Scan one of the following barcodes to select whether to transmit US Postal data, which includes both US Postnet and US Planet, with or without the check digit.



*** Transmit US Postal Check Digit
(1)**



**Do Not Transmit US Postal Check Digit
(0)**

UK Postal

Parameter # 91

SSI # 5Bh

Scan one of the following barcodes to enable or disable UK Postal.



**Enable UK Postal
(1)**



*** Disable UK Postal
(0)**

Transmit UK Postal Check Digit

Parameter # 96

SSI # 60h

Scan one of the following barcodes to select whether to transmit UK Postal data with or without the check digit.



*** Transmit UK Postal
Check Digit
(1)**



**Do Not Transmit UK Postal Check Digit
(0)**

Japan Postal

Parameter # 290

SSI # F0h, 22h

Scan one of the following barcodes to enable or disable Japan Postal.



**Enable Japan Postal
(1)**



*** Disable Japan Postal
(0)**

Australia Post

Parameter # 291

SSI # F0h, 23h

Scan one of the following barcodes to enable or disable Australia Post.



**Enable Australia Post
(1)**



*** Disable Australia Post
(0)**

Australia Post Format

Parameter # 718

SSI # F1h, CEh

Scan one of the following barcodes to select a format for Australia Post:

- **Autodiscriminate** (or Smart mode) - Decode the Customer Information Field using the N and C Encoding Tables.



NOTE: This option increases the risk of misdecodes because the encoded data format does not specify the Encoding Table used for encoding.

- **Raw Format** - Output raw bar patterns as a series of numbers 0 through 3.
- **Alphanumeric Encoding** - Decode the Customer Information Field using the C Encoding Table.
- **Numeric Encoding** - Decode the Customer Information Field using the N Encoding Table.

For more information on Australia Post Encoding Tables, refer to the Australia Post Customer Barcoding Technical Specifications available at auspost.com.au.



* **Autodiscriminate**
(0)



Raw Format
(1)



Alphanumeric Encoding
(2)



Numeric Encoding
(3)

Netherlands KIX Code

Parameter # 326

SSI # F0h, 46h

Scan one of the following barcodes to enable or disable Netherlands KIX Code.



Enable Netherlands KIX Code
(1)



* Disable Netherlands KIX Code
(0)

USPS 4CB/One Code/Intelligent Mail

Parameter # 592

SSI # F1h 50h

Scan one of the following barcodes to enable or disable USPS 4CB/One Code/Intelligent Mail.



Enable USPS 4CB/One Code/Intelligent Mail
(1)



* Disable USPS 4CB/One Code/Intelligent Mail
(0)

UPU FICS Postal

Parameter # 611

SSI # F1h 63h

Scan one of the following barcodes to enable or disable UPU FICS Postal.



Enable UPU FICS Postal
(1)



* Disable UPU FICS Postal
(0)

Mailmark

Parameter # 1337

SSI # F8h 05h 39h

Scan one of the following barcodes to enable or disable Mailmark.

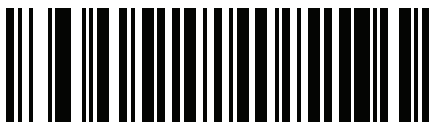

* Disable Mailmark
(0)

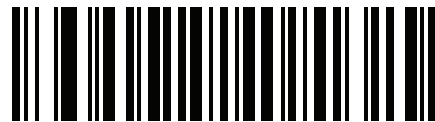

Enable Mailmark
(1)

USB Interface

Introduction

This chapter describes how to set up the scanner with a USB host. The scanner connects directly to a USB host, or a powered USB hub, which powers it. No additional power supply is required.

The scanner ships with the settings shown in [Table 13 on page 237](#) (also see [Parameter Defaults](#) for all defaults). If the default values suit requirements, programming is not necessary.

Setting Parameters

To set feature values, scan a single barcode or a short barcode sequence. The settings are stored in non-volatile memory and are preserved even when the scanner powers down.



NOTE: Most computer monitors allow scanning barcodes directly on the screen. When scanning from the screen, be sure to set the document magnification to a level where you can see the barcode clearly, and bars and/or spaces do not merge.

To return all features to default values, scan [Set Factory Defaults on page 62](#). Throughout the programming barcode menus, asterisks (*) indicate default values.

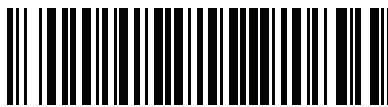

* Indicates default * Enable Parameter Feature/option

Scanning Sequence Examples

In most cases scanning one barcode sets the parameter value. For example, to set the USB keystroke delay to medium, scan the **Medium Delay (20 msec)** barcode under [USB Keystroke Delay on page 241](#). The scanner issues a fast warble beep and the LED turns green, signifying a successful parameter entry.

Other parameters require scanning several barcodes. See the parameter descriptions for this procedure.

Errors While Scanning

Unless otherwise specified, to correct an error during a scanning sequence, just re-scan the correct parameter.

Connecting a USB Interface

Figure 19 USB Connection

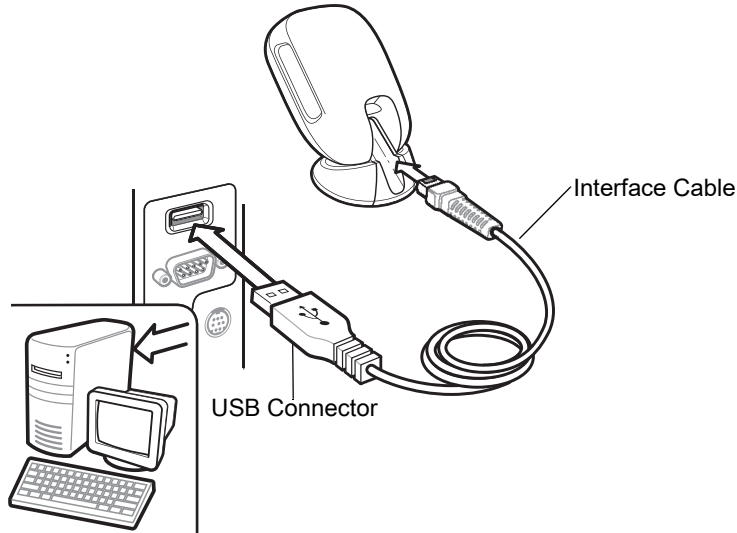

NOTE: When connecting via USB use the shielded connector cable (e.g., p/n CBA-U21-S07ZBR). Refer to Solution Builder for guidance about cables.

For information about cables and cable compatibility, go to the Zebra Partner Portal at: https://partnerportal.zebra.com/PartnerPortal/product_services/downloads_z/barcode_scanners/Universal-Cable-Guide-Bar-Code-Scanners.xlsx.

The scanner connects to USB-capable hosts including:

- TGCS (IBM) terminals
- Apple™ desktop and notebooks
- Other network computers that support more than one keyboard.

The following operating systems support the scanner through USB:

- Windows® XP, 7, 8, 10
- MacOS 8.5 - MacOS 10.6
- IBM 4690 OS
- Linux.

The scanner also interfaces with other USB hosts that support USB Human Interface Devices (HID).

To set up the scanner:

1. Connect the modular connector of the USB interface cable to the cable interface port on the scanner. See [Inserting the Interface Cable on page 31](#).



NOTE: Interface cables vary depending on configuration. The connectors illustrated in [Figure 19](#) are examples only. The connectors may be different than those illustrated, but the steps to connect the scanner are the same.

2. Plug the series A connector in the USB host or hub, or plug the PowerPlus connector in an available port of the IBM SurePOS terminal.
3. The scanner automatically detects the host and uses the default USB device type. If the default (*) does not meet your requirements, select another USB device type by scanning the appropriate barcode from [USB Device Type on page 239](#).
4. On first installation when using Windows, the software may prompt to select or install the Human Interface Device driver. To install this driver, provided by Windows, click **Next** at all choices and click **Finished** on the last choice. The scanner powers up during this installation.
5. To modify any other parameter options, scan the appropriate barcodes in this chapter.

If problems occur with the system, see [Troubleshooting on page 51](#).

USB Parameter Defaults

[Table 13](#) lists defaults for USB host parameters. Change these values in one of two ways:

- Scan the appropriate barcodes in this chapter. The new value replaces the standard default value in memory. To recall default parameter values, see [Default Parameters on page 62](#).
- Configure the scanner using the 123Scan configuration program. See [123Scan and Software Tools](#).



NOTE: See [Parameter Defaults](#) for all user preference, host, symbology, and miscellaneous default parameters.

Table 13 USB Interface Parameter Defaults

Parameter	Default	Page Number
USB Host Parameters		
USB Device Type	USB Keyboard HID	239
Symbol Native API (SNAPI) Status Handshaking	Enable	241
USB Keystroke Delay	No Delay	241
USB Caps Lock Override	Disable	242
Barcodes with Unknown Characters	Send Barcodes with Unknown Characters	242
USB Convert Unknown to Code 39	Disable	243
USB Fast HID	Enable	243
USB Polling Interval	3 msec	244
Keypad Emulation	Enable	246
Quick Keypad Emulation	Enable	246
Keypad Emulation with Leading Zero	Enable	247
USB FN1 Substitution	Disable	247
Function Key Mapping	Disable	248

Table 13 USB Interface Parameter Defaults (Continued)

Parameter	Default	Page Number
Simulated Caps Lock	Disable	248
Convert Case	None	249
USB Static CDC	Enable	250
CDC Beep on <BEL>	Enable	250
TGCS (IBM) USB Beep Directive	Ignore	250
TGCS (IBM) USB Barcode Configuration Directive	Ignore	251
TGCS (IBM) USB Specification Version	Version 2.2	251
USB CDC Host Variant	Standard CDC	252

USB Host Parameters

USB Device Type

Scan one of the following barcodes to select the USB device type. To select a country keyboard type for the **USB Keyboard HID** host, see [Country Codes](#).



NOTES:

- When changing USB Device Types, the scanner resets and issues the standard startup beep sequences.
- When connecting two scanners to a host, IBM does not allow selecting two of the same device type. If you require two connections, select IBM Table-top USB for one scanner and IBM Hand-held USB for the second scanner.
- Select **IBM Hand-held USB** to disable data transmission when an IBM register issues a Scan Disable command. Aim, illumination, and decoding is still permitted. Select **IBM OPOS (IBM Hand-held USB with Full Scan Disable)** to completely shut off the scanner when an IBM register issues a Scan Disable command, including aim, illumination, decoding, and data transmission.
- To select the Toshiba TEC device type, refer to the Toshiba TEC Programmer's Guide.

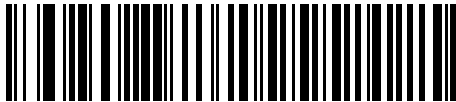

* USB Keyboard HID



IBM Table-top USB

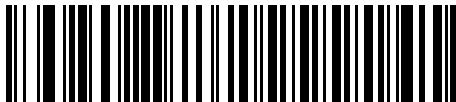

IBM Hand-held USB



IBM OPOS
(IBM Hand-held USB with Full Scan Disable)

USB Device Type (continued)



NOTES:

- Before selecting [USB CDC Host on page 240](#) or [SSI over USB CDC on page 240](#), install the appropriate USB CDC Driver on the host to ensure the scanner does not stall during power up (due to a failure to enumerate USB). Go to zebra.com/support, Support & Downloads > Barcode Scanners > USB CDC Driver, select the appropriate Windows platform, and download the appropriate CDC Driver (64 bit or 32 bit).
To recover a stalled scanner:
Install the USB CDC Driver
or
After power-up, hold the trigger for 10 seconds, which allows the scanner to power up using an alternate USB configuration. Upon power-up, scan another **USB Device Type**.
- Select **USB HID POS** to communicate over a USB cable with Universal Windows Platform (UWP) applications running on Windows 10 devices.



USB CDC Host

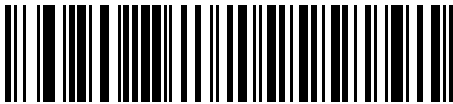

SSI over USB CDC



Symbol Native API (SNAPI) with Imaging Interface



Symbol Native API (SNAPI) without Imaging Interface



**USB HID POS
(for Windows 10 devices only)**

Symbol Native API (SNAPI) Status Handshaking

After selecting a SNAPI interface as the USB device type, scan one of the following barcodes to select whether to enable or disable status handshaking.



*** Enable SNAPI Status Handshaking**



Disable SNAPI Status Handshaking

USB Keystroke Delay

Scan one of the following barcodes to set the delay, in milliseconds, between emulated keystrokes. Select a longer delay for hosts that require slower data transmission.

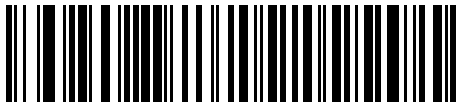

*** No Delay**



Medium Delay (20 msec)

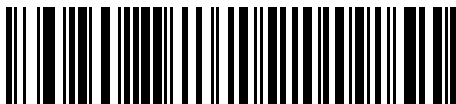

Long Delay (40 msec)

USB Caps Lock Override

This option applies only to the USB Keyboard HID device. Scan **Override Caps Lock Key** to preserve the case of the data regardless of the state of the **Caps Lock** key. This setting is always enabled for the Japanese Windows (ASCII) keyboard type and can not be disabled.



**Override Caps Lock Key
(Enable)**

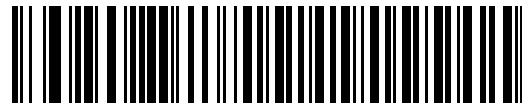

*** Do Not Override Caps Lock Key
(Disable)**

Barcodes with Unknown Characters

This option applies only to the USB Keyboard HID and IBM devices. Unknown characters are characters the host does not recognize. Scan **Send Barcodes With Unknown Characters** to send all barcode data except for unknown characters. The scanner issues no error beeps.

Scan **Do Not Send Barcodes With Unknown Characters** for IBM devices to prevent sending barcodes containing at least one unknown character to the host, or for USB Keyboard HID devices to send the barcode characters up to the unknown character. The scanner issues an error beep.

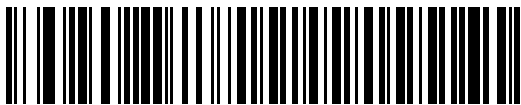

*** Send Barcodes with Unknown Characters**

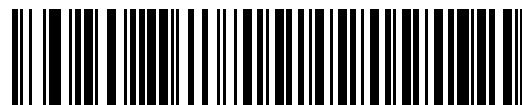

Do Not Send Barcodes with Unknown Characters

USB Convert Unknown to Code 39

This option applies only to the IBM hand-held, IBM table-top, and OPOS devices. Scan one of the following barcodes to enable or disable converting unknown barcode type data to Code 39.

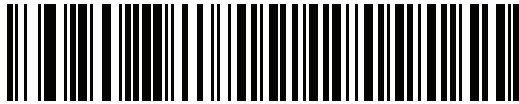

Enable Convert Unknown to Code 39



*** Disable Convert Unknown to Code 39**

USB Fast HID

Scan **Enable USB Fast HID** to transmit USB HID data at a faster rate.



NOTE: Disable **USB Fast HID** if there are problems with transmission.



*** Enable USB Fast HID**

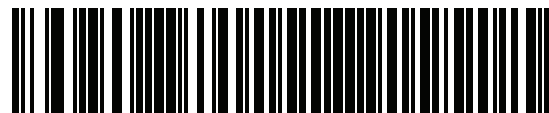

Disable USB Fast HID

USB Polling Interval

Scan one of the following barcodes to set the polling interval, which is the rate at which data transmits between the scanner and host computer. A lower number indicates a faster data rate.



NOTE: When changing the USB polling interval, the scanner restarts and issues a power-up beep sequence.



IMPORTANT: Ensure the host supports the selected data rate.

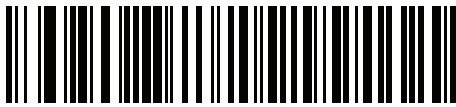

1 msec



2 msec

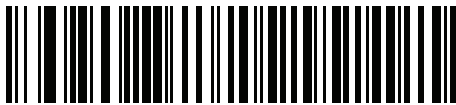

* 3 msec



4 msec

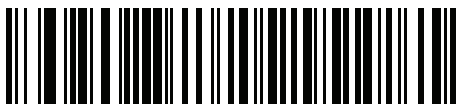

5 msec

USB Polling Interval (continued)

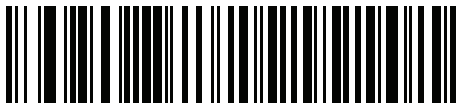

6 msec



7 msec

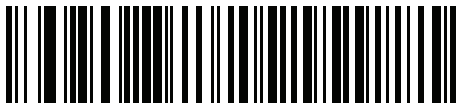

8 msec

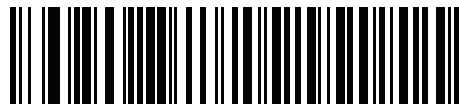

9 msec

Keypad Emulation

Scan **Enable Keypad Emulation** to send all characters as ASCII sequences over the numeric keypad. For example, ASCII A transmits as “ALT make” 0 6 5 “ALT Break”.



NOTE: If your keyboard type is not listed in the country code list (see [Country Codes](#)), disable [Quick Keypad Emulation](#) and enable **Keypad Emulation** below.



* **Enable Keypad Emulation**



Disable Keypad Emulation

Quick Keypad Emulation

This option applies only to the USB Keyboard HID device when [Keypad Emulation](#) is enabled. Scan **Enable Quick Keypad Emulation** for a quicker method of emulation using the numeric keypad where ASCII sequences are only sent for ASCII characters not found on the keyboard.



* **Enable Quick Keypad Emulation**



Disable Quick Keypad Emulation

Keypad Emulation with Leading Zero

Scan **Enable Keypad Emulation with Leading Zero** to send character sequences sent over the numeric keypad as ISO characters which have a leading zero. For example, ASCII A transmits as “ALT MAKE” 0 0 6 5 “ALT BREAK”.



* **Enable Keypad Emulation with Leading Zero**



Disable Keypad Emulation with Leading Zero

USB Keyboard FN1 Substitution

This option applies only to the USB Keyboard HID device. Scan **Enable USB Keyboard FN1 Substitution** to replace any FN1 character in a GS1 128 barcode with a user-selected Key Category and value. See [FN1 Substitution Values on page 93](#) to set the Key Category and Key Value.

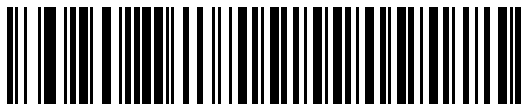

Enable USB Keyboard FN1 Substitution

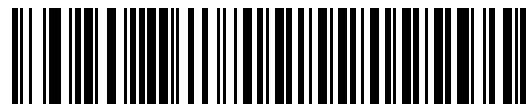

* **Disable USB Keyboard FN1 Substitution**

Function Key Mapping

ASCII values under 32 are normally sent as a control-key sequence (see [Table 33 on page 460](#)). Scan **Enable Function Key Mapping** to send the keys in bold in place of the standard key mapping. Table entries that do not have a bold equivalent remain the same regardless of whether you enable this parameter.



Enable Function Key Mapping

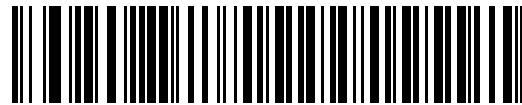

*** Disable Function Key Mapping**

Simulated Caps Lock

Scan **Enable Simulated Caps Lock** to invert upper and lower case characters on the barcode as if the Caps Lock state is enabled on the keyboard. This inversion occurs regardless of the keyboard's **Caps Lock** state.



NOTES: - Simulated Caps Lock applies to ASCII characters only.

- Do not enable this parameter if any of the following parameters are enabled:

[USB Caps Lock Override on page 242](#)

[Convert All to Upper Case on page 249](#)

[Convert All to Lower Case on page 249](#)

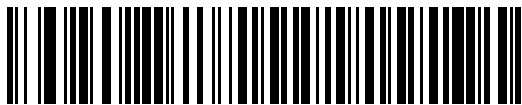

Enable Simulated Caps Lock

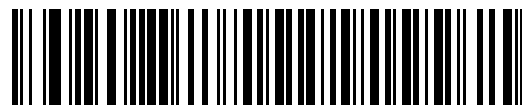

*** Disable Simulated Caps Lock**

Convert Case

Scan one of the following barcodes to convert all barcode data to the selected case.



NOTE: Convert Case applies to ASCII characters only.

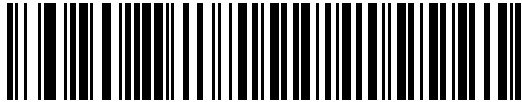

*** No Case Conversion**

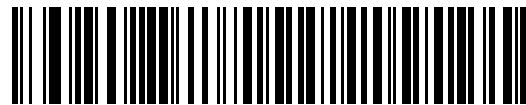

Convert All to Upper Case

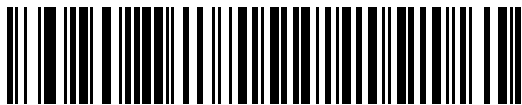

Convert All to Lower Case

USB Static CDC

When disabled, each device connected consumes another COM port (first device = COM1, second device = COM2, third device = COM3, etc.)

When enabled, each device connects to the same COM port.



*** Enable USB Static CDC**



Disable USB Static CDC

CDC Beep on <BEL>

If you enable this parameter, the scanner issues a beep when it detects a <BEL> character in USB CDC communications. <BEL> indicates an illegal entry or other important event.

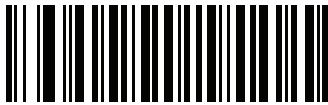

*** Enable CDC Beep on <BEL>**

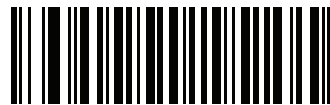

Disable CDC Beep on <BEL>

TGCS (IBM) USB Beep Directive

The host can send a beep configuration request to the scanner. Scan **Ignore Beep Directive** to prevent the scanner from processing the host request. All directives are still acknowledged to the USB host as if they were processed.



Honor Beep Directive



*** Ignore Beep Directive**

TGCS (IBM) USB Barcode Configuration Directive

The host can enable and disable code types. Scan **Ignore Barcode Configuration Directive** to prevent the scanner from processing the host request. All directives are still acknowledged to the USB host as if they were processed.



Honor Barcode Configuration Directive



*** Ignore Barcode Configuration Directive**

TGCS (IBM) USB Specification Version

Select **IBM Specification Level Version 0 (Original)** to send the following code types as Unknown:

- Data Matrix
- GS1 Data Matrix
- QR Code
- GS1 QR
- MicroQR Code
- Aztec

Select **IBM Specification Level Version 2.2** to send the code types with the appropriate IBM identifiers.



IBM Specification Level Version 0 (Original)



*** IBM Specification Level Version 2.2**

USB CDC Host Variant

Parameter # 1713 (SSI # F8 06 B1)

The USB Airline/Airport(CUTE/CUSS/CUPS) CDC Host Variant feature is similar to the RS232 host variant(CUTE). It is now supported over USB CDC host mode. The scanner transmits data in Airline/Airport(CUTE/CUSS/CUPS) data format <Prefix><Data><Suffix>.

The USB Airline/Airport(CUTE/CUSS/CUPS) feature supports 2 CDC Host Variants. One for each ISV (Independent Software Vendor) spec: STIA and ARINC. The default USB CDC Host Variant is Standard CDC host mode.

Table 14 USB CDC Host Variant Parameter Values

CDC Host Variant	Parameter Value
CDC Standard (default)	N06B100
CDC SITA	N06B101
CDC TravelSky	N06B102
CDC ARINC	N06B103

Parameter Scanning Lockout

If the scanner is configured as USB CDC Host Variant (other than CDC Standard), it will disable all parameter barcodes scanning. To unlock, scan * [Enable Parameter Barcode Scanning \(1\) on page 63](#).

Parameter Default

Enabling of any of the USB CDC Host Variant (other than CDC Standard) requires coercion of other parameters. The scanner updates the following parameters (Table2) to the specified default values based on the USB CDC Host Variant selected.

Table 15 Parameter Defaults for Airport Device Types

Parameter	SITA Defaults	ARINC Defaults	Travel Sky Defaults
IATA 2 of 5 (D 2 of 5)	Enabled	Enabled	Enabled
Parameter Scanning	Disabled	Disabled	Disabled
IATA 2 of 5 (D 2 of 5) Lengths	6 to 55	6 to 55	6 to 56
I 2 of 5	Enabled	Enabled	Enabled

Parameter	SITA Defaults	ARINC Defaults	Travel Sky Defaults
I 2 of 5 Lengths	4 to 56	4 to 56	4 to 56
Micro PDF	Enabled	N/R	Enabled
PDF417	N/R	Enabled	N/R
Code 39	N/R	Enabled	N/R
Code 128	N/R	Enabled	N/R
Triggered Same Symbol Timeout	Enabled	Enabled	Enabled
Transmit Code ID	Disabled	Disabled	Disabled

Transmitting Data Formatting

- SITA Format - The USB SITA feature transmits data in SITA format: <STX><ID><DATA><CR><ETX>
Where:
 - <STX> - 0X02
 - <ID> - Custom Code ID (see [Table 16](#))
 - <DATA> - Barcode decode data
 - <CR> - 0x0d
 - <ETX> - 0x03

Table 16 SITA Code ID

Code Type	Code ID Character
I 2 of 5	1
D 2 of 5, IATA	2
Code 39 (all variants)	3
Data Matrix	4
Code 128 (all variants)	5
PDF (all variants)	6
QR Code (all variants)	7
Aztec Code (all variants)	8
UPCA, EAN13, (all supplemental variants)	A
All others	None

- ARINC Format - The USB SITA feature transmits data in ARINC format: <STX><DID><DOC><BID><DATA><ETX><CRC>
Where:
 - <STX> - 0X02
 - <DID> - 0xB1 (DTYP and DNUM)
 - <DOC> - 0x03 (Document Identifier)
 - <BID> - Barcode Identifier (see [Table 17](#))
 - <DATA> - Barcode Decode Data
 - <ETX> - 0x03
 - <CRC> - CRC-16

Table 17 ARINC Barcode Identifier

Code Type	ASCII Value
I 2 of 5	1
D 2 of 5	2
Code 39	3

USB Interface

Code Type	ASCII Value
Code 128	5
Code 39 with Check Digit*	8
D 2 of 5 with Check Digit*	9
I 2 of 5 with Check Digit*	0
2D Data Matix	4
2D QR	7
2D PDF	6
EAN 13 with Check Digit*	A
2D Aztec	8
All others	None

Note: Not supported on scanner; specified in ARINC spec.; No distinguish of Check Digits without AIM Code ID Transmit.

- TravelSky Format - The USB SITA feature transmits data in TravelSky format: <ID><DATA>
Where:
 <ID> - Custom Code ID (same as [Table 16 on page 253](#))
 <DATA> - Barcode Decode Data

Select a USB CDC Host Variant.



Standard CDC



SITA



TRVSKEY



ARINC

ASCII Character Sets

See [ASCII Character Sets](#) for the following information:

- ASCII Character Set, [Table 33 on page 460](#)
- ALT Key Character Set, [Table 34 on page 465](#)
- GUI Key Character Set, [Table 35 on page 466](#)
- PF Key Character Set, [Table 36 on page 467](#)
- F Key Character Set, [Table 37 on page 468](#)
- Numeric Key Character Set, [Table 38 on page 468](#)
- Extended Key Character Set, [Table 39 on page 469](#)

SSI Interface

Introduction

This chapter describes the system requirements of the Simple Serial Interface (SSI), which provides a communications link between Zebra decoders (e.g., scan engines, slot scanners, hand-held scanners, two-dimensional scanners, Hands-free scanners, and RF base stations) and a serial host. It provides the means for the host to control the decoder or scanner.

Communication

All communication between the scanner and host occurs over the hardware interface lines using the SSI protocol. Refer to the Simple Serial Interface Programmer's Guide, p/n 72E-40451-xx, for more information on SSI.

The host and the scanner exchange messages in packets. A packet is a collection of bytes framed by the proper SSI protocol formatting bytes. The maximum number of bytes per packet that the SSI protocol allows for any transaction is 257 (255 bytes + 2 byte checksum).

Depending on the configuration, the scanner can send decode data as ASCII data (unpacketed), or as part of a larger message (packeted).

SSI performs the following functions for the host device:

- Maintains a bi-directional interface with the scanner
- Allows the host to send commands that control the scanner
- Passes data from the scanner to a host device in SSI packet format or straight decode message.

The SSI environment consists of a scanner, a serial cable which attaches to the host device, and if required, a power supply.

SSI transmits all decode data including special formatting (e.g., AIM ID). Parameter settings can control the format of the transmitted data.

The scanner can also send parameter information, product identification information, or event codes to the host.

All commands sent between the scanner and host must use the format described in the SSI Message Formats section. [SSI Transactions on page 258](#) describes the required sequence of messages in specific cases.

SSI Commands

Table 18 lists all the SSI opcodes the scanner supports. The host transmits opcodes designated type H. The scanner (decoder) transmits type D opcodes, and either can transmit Host/Decoder (H/D) types.

Table 18 SSI Commands

Name	Type	Opcode	Description
AIM_OFF	H	0xC4	Deactivate aim pattern.
AIM_ON	H	0xC5	Activate aim pattern.
BEEP	H	0xE6	Sound the beeper.
CAPABILITIES_REPLY	D	0xD4	Reply to CAPABILITIES_REQUEST; contains a list of the capabilities and commands the decoder supports.
CAPABILITIES_REQUEST	H	0xD3	Request capabilities report from the decoder.
CMD_ACK	H/D	0xD0	Positive acknowledgment of received packet.
CMD_NAK	H/D	0xD1	Negative acknowledgment of received packet.
DECODE_DATA	D	0xF3	Decode data in SSI packet format.
EVENT	D	0xF6	Event indicated by associated event code.
LED_OFF	H	0xE8	De-activate LED output.
LED_ON	H	0xE7	Activate LED output.
PARAM_DEFAULTS	H	0xC8	Set parameter default values.
PARAM_REQUEST	H	0xC7	Request values of certain parameters.
PARAM_SEND	H/D	0xC6	Send parameter values.
REPLY_REVISION	D	0xA4	Reply to REQUEST_REVISION, contains the decoder's software/hardware configuration.
REQUEST_REVISION	H	0xA3	Request the decoder's configuration.
SCAN_DISABLE	H	0xEA	Prevent the operator from scanning barcodes.
SCAN_ENABLE	H	0xE9	Permit barcode scanning.
SLEEP	H	0xEB	Request to place the decoder into low power.
START_DECODE	H	0xE4	Tell the decoder to attempt to decode a barcode.
STOP_DECODE	H	0xE5	Tell the decoder to abort a decode attempt.
WAKEUP	H	N/A	Wake the decoder from low power mode.

For details of the SSI protocol, refer to the *Simple Serial Interface Programmer's Guide*.

SSI Transactions

General Data Transactions

ACK/NAK Handshaking

If you enable ACK/NAK handshaking (the default), all packeted messages must have a CMD_ACK or CMD_NAK response, unless the command description states otherwise. Zebra recommends leaving this handshaking enabled to provide feedback to the host. Raw decode data and WAKEUP do not use ACK/NAK handshaking since they are not packeted data.

Following is an example of a problem which can occur if you disable ACK/NAK handshaking:

- The host sends a PARAM_SEND message to the scanner to change the baud rate from 9600 to 19200.
- The scanner cannot interpret the message.
- The scanner does not implement the change the host requested.
- The host assumes that the parameter change occurred and acts accordingly.
- Communication is lost because the change did not occur on both sides.

If you enable ACK/NAK handshaking, the following occurs:

- The host sends a PARAM_SEND message.
- The scanner cannot interpret the message.
- The scanner CMD_NAKs the message.
- The host resends the message.
- The scanner receives the message successfully, responds with CMD_ACK, and implements parameter changes.

Decoded Data Transmission

The [Decode Data Packet Format](#) parameter controls how decode data is sent to the host. Set this parameter to send the data in a DECODE_DATA packet. Clear this parameter to transmit the data as raw ASCII data.



NOTE: When transmitting decode data as raw ASCII data, ACK/NAK handshaking does not apply regardless of the state of the ACK/NAK handshaking parameter.

ACK/NAK Enabled and Packeted Data

The scanner sends a DECODE_DATA message after a successful decode. The scanner waits for a programmable timeout for a CMD_ACK response. If it does not receive the response, the scanner tries to send two more times before issuing a host transmission error. If the scanner receives a CMD_NAK from the host, it may attempt a retry depending on the cause field of the CMD_NAK message.

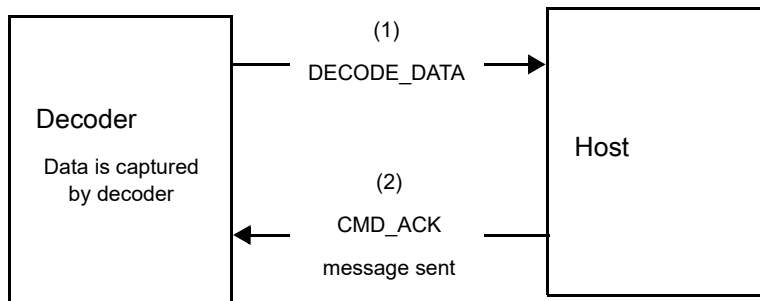

ACK/NAK Enabled and Unpacketed ASCII Data

Even if ACK/NAK handshaking is enabled, no handshaking occurs because handshaking applies only to packeted data. In this example the packeted_decode parameter is disabled.

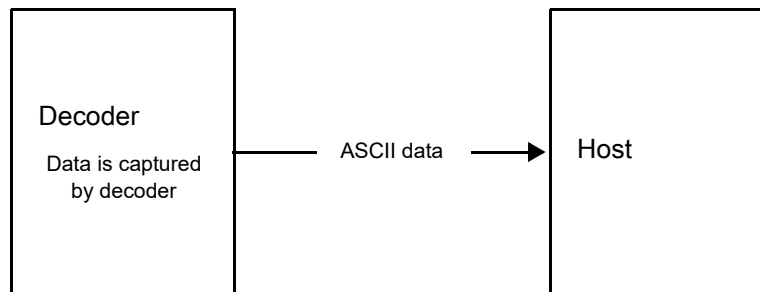

ACK/NAK Disabled and Packeted DECODE_DATA

In this example ACK/NAK does not occur even though packeted_decode is enabled because the ACK/NAK handshaking parameter is disabled.

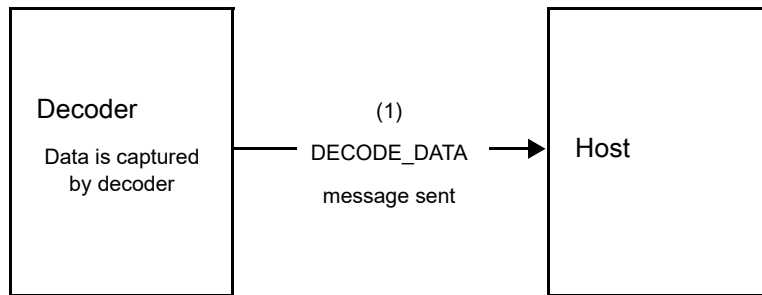

ACK/NAK Disabled and Unpacketed ASCII Data

The decoder sends captured data to the host.

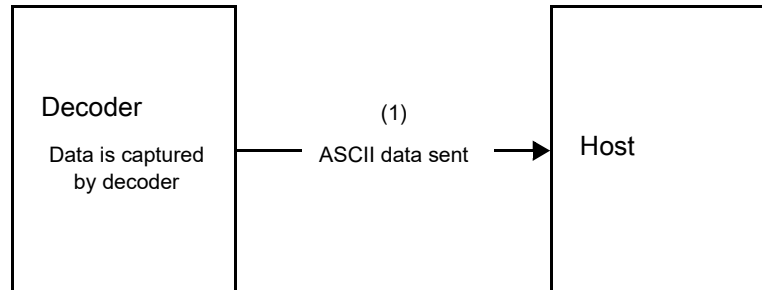

Communication Summary

RTS/CTS Lines

All communication must use RTS/CTS handshaking as described in the *Simple Serial Interface Programmer's Guide*, p/n 72E-40451-xx. If bypassing hardware handshaking, the host must send the WAKEUP command before all other communication or the first byte of a message can be lost during the scanner wakeup sequence. Zebra recommends not bypassing RTS/CTS hardware handshaking.

ACK/NAK Option

ACK/NAK handshaking is enabled by default and Zebra recommends leaving it enabled. Disabling this can cause communication problems, as handshaking is the only acknowledgment that a message was received correctly. ACK/NAK is not used with unpacketed decode data regardless of whether it is enabled.

Number of Data Bits

All communication with the scanner must use 8-bit data.

Serial Response Timeout

The [Host Serial Response Timeout](#) parameter determines how long to wait for a handshaking response before trying again or aborting further attempts. Set the same value for both the host and scanner.



NOTE: You can temporarily change the [Host Serial Response Timeout](#) when the host takes longer to process an ACK or longer data string. Zebra does not recommend frequent permanent changes due to limited write cycles of non-volatile memory.

Retries

The host resends data twice after the initial send if the scanner does not respond with an ACK or NAK (if ACK/NAK handshaking is enabled), or response data (e.g., PARAM_SEND, REPLY_REVISION). If the scanner replies with a NAK RESEND, the host resends the data. All resent messages must have the resend bit set in the Status byte.

The scanner resends data two times after the initial send if the host fails to reply with an ACK or NAK (if ACK/NAK handshaking is enabled).

Baud Rate, Stop Bits, Parity, Response Timeout, ACK/NAK Handshaking

If you use PARAM_SEND to change these serial parameters, the ACK response to the PARAM_SEND uses the previous values for these parameters. The new values then take effect for the next transaction.

Errors

The scanner issues a communication error when:

- The CTS line is asserted when the scanner tries to transmit, and is still asserted on each of two successive retries
- The scanner does not receive an ACK or NAK after initial transmit and two resends.

SSI Communication Notes

- When not using hardware handshaking, space messages sufficiently apart. The host must not communicate with the scanner if the scanner is transmitting.
- When using hardware handshaking, frame each message properly with handshaking signals. Do not try to send two commands within the same handshaking frame.
- There is a permanent/temporary bit in the PARAM_SEND message. Removing power from the scanner discards temporary changes. Permanent changes are written to non-volatile memory. Frequent changes shorten the life of the non-volatile memory.

Using Time Delay to Low Power Mode with SSI

[Time Delay to Low Power Mode on page 72](#) provides options to select a general time delay. To program a more specific delay value, use an SSI command according to [Table 19](#).

Table 19 Values for Selecting Time Delay to Low Power

Value	Timeout	Value	Timeout	Value	Timeout	Value	Timeout
0x00	15 Min	0x10	1 Sec	0x20	1 Min	0x30	1 Hour
0x01	30 Min	0x11	1 Sec	0x21	1 Min	0x31	1 Hour
0x02	60 Min	0x12	2 Sec	0x22	2 Min	0x32	2 Hours
0x03	90 Min	0x13	3 Sec	0x23	3 Min	0x33	3 Hours
N/A	N/A	0x14	4 Sec	0x24	4 Min	0x34	4 Hours
N/A	N/A	0x15	5 Sec	0x25	5 Min	0x35	5 Hours
N/A	N/A	0x16	6 Sec	0x26	6 Min	0x36	6 Hours
N/A	N/A	0x17	7 Sec	0x27	7 Min	0x37	7 Hours
N/A	N/A	0x18	8 Sec	0x28	8 Min	0x38	8 Hours
N/A	N/A	0x19	9 Sec	0x29	9 Min	0x39	9 Hours
N/A	N/A	0x1A	10 Sec	0x2A	10 Min	0x3A	10 Hours
N/A	N/A	0x1B	15 Sec	0x2B	15 Min	0x3B	15 Hours
N/A	N/A	0x1C	20 Sec	0x2C	20 Min	0x3C	20 Hours
N/A	N/A	0x1D	30 Sec	0x2D	30 Min	0x3D	30 Hours
N/A	N/A	0x1E	45 Sec	0x2E	45 Min	0x3E	45 Hours
N/A	N/A	0x1F	60 Sec	0x2F	60 Min	0x3F	60 Hours



CAUTION: With hardware handshaking disabled, the scanner wakes from low power mode upon receiving a character. However, the scanner does not process this character or any others it receives during the 10 ms period following wakeup. Wait at least 10 ms after wakeup to send valid characters.

Encapsulation of RSM Commands/Responses over SSI

The SSI protocol allows the host to send a command that is variable in length up to 255 bytes. Although there is a provision in the protocol to multi-packet commands from the host, the scanner does not support this. The host must fragment packets using the provisions in the RSM protocol.

Command Structure

Byte	7	6	5	4	3	2	1	0
0	Length (not including the checksum)							
1	SSI_MGMT_COMMAND (0x80)							
2	Message Source (4 - Host)							
3	Reserved (0)			Reserved (0)		Reserved (0)	Cont'd packet	Retransmit
4	Payload data (see the following example)							
...								
Length -1								
Length	2's complement checksum (MSB)							
Length +1	2's complement checksum (LSB)							

The expected positive response is SSI_MGMT_COMMAND which can be a multi-packet response. Devices that do not support this command respond with the standard SSI_NAK.

Response Structure

Byte	7	6	5	4	3	2	1	0
0	Length (not including the checksum)							
1	SSI_MGMT_COMMAND (0x80)							
2	Message Source (0 - Decoder)							
3	Reserved (0)			Reserved (0)		Reserved (0)	Cont'd packet	Retransmit
4	Payload data (see the following example)							
...								
Length -1								
Length	2's complement checksum (MSB)							
Length +1	2's complement checksum (LSB)							

Example Transaction

The following example illustrates how to retrieve diagnostic information (Diagnostic Testing and Reporting (Attribute #10061) decimal) from the scanner using encapsulation of RSM commands over SSI. Before sending an RSM command, the host must send the RSM Get Packet Size command to query the packet size supported by the device.

Command from Host to Query Packet Size Supported by Device

```
0A 80 04 00 00 06 20 00 FF FF FD 4E
```

Where:

- 0A 80 04 00 is encapsulation of RSM commands over SSI command header
- 00 06 20 00 FF FF is RSM Get Packet Size command
- FD 4E is SSI command checksum

Response from Device with Packet Size Information

```
0C 80 00 00 00 08 20 00 00 F0 00 F0 FD 6C
```

Where:

- 0C 80 00 00 is encapsulation of RSM command over SSI command header
- 00 08 20 00 00 F0 00 F0 is RSM Get Packet Size response
- FD 6C is SSI response checksum

Command from Host to Retrieve Diagnostic Information

```
0C 80 04 00 00 08 02 00 27 4D 42 00 FE B0
```

Where:

- 0C 80 04 00 is encapsulation of RSM commands over SSI command header
- 00 08 02 00 27 4D 42 00 is attribute Get command requesting attribute 10061 decimal
- FE B0 is SSI command checksum

Response from Device with Diagnostic Information

```
21 80 00 00 00 1D 02 00 27 4D 41 01 42 00 0E 00 00 00 00 01 03 02 03 03 03 04 03 05 03 06 03 FF FF FC 15
```

Where:

- 21 80 00 00 00 1D 02 00 27 4D 41 01 42 00 0E 00 00 is encapsulation of RSM responses over SSI command header
- 00 00 01 03 02 03 03 03 04 03 05 03 06 03 is attribute Get response which includes diagnostic report value
- FF FF is attribute Get response, packet termination
- FC 15 is SSI response checksum

Setting Parameters

This section describes how to set up the scanner with an SSI host. When using SSI, program the scanner via barcode menu or SSI hosts commands.

The scanner ships with the settings shown in [Table 20 on page 266](#) (also see [Parameter Defaults](#) for all defaults). If the default values suit requirements, programming is not necessary.

To set feature values, scan a single barcode or a short barcode sequence. The settings are stored in non-volatile memory and are preserved even when the scanner powers down.



NOTE: Most computer monitors allow scanning barcodes directly on the screen. When scanning from the screen, be sure to set the document magnification to a level where you can see the barcode clearly, and bars and/or spaces do not merge.

To return all features to default values, scan [Set Factory Defaults on page 62](#). Throughout the programming barcode menus, asterisks (*) indicate default values.

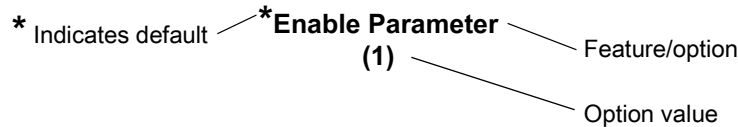
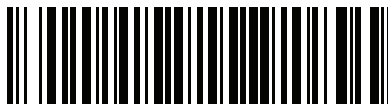

Scanning Sequence Examples

In most cases scanning one barcode sets the parameter value. For example, to set the baud rate to 19,200, scan the **Baud Rate 19,200** barcode under [Baud Rate on page 267](#). The scanner issues a fast warble beep and the LED turns green, signifying a successful parameter entry.

Other parameters require scanning several barcodes. See the parameter descriptions for this procedure.

Errors While Scanning

Unless otherwise specified, to correct an error during a scanning sequence, just re-scan the correct parameter.

Simple Serial Interface Parameter Defaults

Table 18 lists defaults for SSI host parameters. Change these values in one of two ways:

- Scan the appropriate barcodes in this chapter. The new value replaces the standard default value in memory. To recall default parameter values, see [Default Parameters on page 62](#).
- Download data through the device’s serial port using SSI. Hexadecimal parameter numbers appear in this chapter below the parameter title, and option values appear in parenthesis beneath the accompanying barcodes. Refer to the *Simple Serial Interface (SSI) Programmer’s Guide* for detailed instructions for changing parameters using this method.



NOTE: SSI interprets Prefix, Suffix1, and Suffix2 values listed in [ASCII Character Set on page 460](#) differently than other interfaces. SSI does not recognize key categories, only the 3-digit decimal value. The default value of 7013 is interpreted as CR only.



NOTE: See [Parameter Defaults](#) for all user preference, host, symbology, and miscellaneous default parameters.

Table 20 SSI Interface Default Table

Parameter	Parameter Number	SSI Number	Default	Page Number
SSI Host Parameters				
Select SSI Host	N/A	N/A	N/A	267
Baud Rate	156	9Ch	9600	267
Parity	158	9Eh	None	269
Check Parity	151	97h	Disable	270
Stop Bits	157	9Dh	1	270
Software Handshaking	159	9Fh	ACK/NAK	271
Host RTS Line State	154	9Ah	Low	272
Decode Data Packet Format	238	EEh	Send Raw Decode Data	273
Host Serial Response Timeout	155	9Bh	Low - 2 Seconds	274
Host Character Timeout	239	EFh	Low - 200 msec	275
Multipacket Option	334	F0h 4Eh	Multipacket Option 1	276
Interpacket Delay	335	F0h 4Fh	Minimum - 0 msec	277
Event Reporting				
Decode Event	256	F0h 00h	Disable	278
Boot Up Event	258	F0h 02h	Disable	279
Parameter Event	259	F0h 03h	Disable	280

SSI Host Parameters

Select SSI Host

To select SSI as the host interface, scan the following barcode.



SSI Host

Baud Rate

Parameter # 156

SSI # 9Ch

Baud rate is the number of bits of data transmitted per second. Scan one of the following barcodes to set the scanner's baud rate to match the baud rate setting of the host device. Otherwise, data may not reach the host device or may reach it in distorted form.



*** Baud Rate 9600
(6)**



**Baud Rate 19,200
(7)**



**Baud Rate 38,400
(8)**



**Baud Rate 57,600
(10)**

Baud Rate (continued)



**Baud Rate 115,200
(11)**



**Baud Rate 230,400
(13)**



**Baud Rate 460,800
(14)**



**Baud Rate 921,600
(15)**

Parity

Parameter # 158

SSI # 9Eh

A parity check bit is the most significant bit of each ASCII coded character. Scan one of the following barcodes to select the parity type according to host device requirements:

- **Odd** - This sets the parity bit value to 0 or 1, based on data, to ensure that the coded character contains an odd number of 1 bits.
- **Even** - This sets the parity bit value to 0 or 1, based on data, to ensure that the coded character contains an even number of 1 bits.
- **None** - No parity bit is required.



**Odd
(2)**



**Even
(1)**



*** None
(0)**

Check Parity

Parameter # 151

SSI # 97h

Scan one of the following barcodes to select whether to check the parity of received characters. See [Parity](#) to select the type of parity.



*** Do Not Check Parity
(0)**



**Check Parity
(1)**

Stop Bits

Parameter # 157

SSI # 9Dh

The stop bit(s) at the end of each transmitted character marks the end of transmission of one character and prepares the receiving device for the next character in the serial data stream. Scan one of the following barcodes to set the number of stop bits (one or two) based on the number the receiving host can accommodate.



*** 1 Stop Bit
(1)**



**2 Stop Bits
(2)**

Software Handshaking

Parameter # 159

SSI # 9Fh

This parameter offers control of data transmission in addition to the control hardware handshaking offers. Hardware handshaking is always enabled; you cannot disable it.

Options:

- **Disable ACK/NAK Handshaking** - The scanner neither generates nor expects ACK/NAK handshaking packets.
- **Enable ACK/NAK Handshaking** - After transmitting data, the scanner expects either an ACK or NAK response from the host. The scanner also ACKs or NAKs messages from the host.

The scanner waits up to the programmable [Host Serial Response Timeout](#) to receive an ACK or NAK. If the scanner does not get a response in this time, it resends its data up to two times before discarding the data and declaring a transmission error.



**Disable ACK/NAK
(0)**



*** Enable ACK/NAK
(1)**

Host RTS Line State

Parameter # 154

SSI # 9Ah

Scan one of the following barcodes to set the expected idle state of the Serial Host RTS line.

The SSI interface is used with host applications which also implement the SSI protocol. However, you can use the scanner in a "scan-and-transmit" mode to communicate with any standard serial communication software on a host PC (see [Decode Data Packet Format on page 273](#)). If transmission errors occur in this mode, the host PC may be asserting hardware handshaking lines which interfere with the SSI protocol. Scan the **High** barcode to address this problem.



* Low
(0)



High
(1)

Decode Data Packet Format

Parameter # 238

SSI # EEh

Scan one of the following barcodes to select whether to transmit decoded data in raw format (unpacketed), or with the packet format defined by the serial protocol.

Selecting the raw format disables ACK/NAK handshaking for decode data.



*** Send Raw Decode Data
(0)**



**Send Packeted Decode Data
(1)**

Host Serial Response Timeout

Parameter # 155

SSI # 9Bh

Scan one of the following barcodes to specify how long the scanner waits for an ACK or NAK before resending. Also, if the scanner wants to send, and the host has already been granted permission to send, the scanner waits for the designated timeout before declaring an error.



NOTE: Other values are available via SSI commands.



*** Low - 2 Seconds
(20)**



**Medium - 5 Seconds
(50)**



**High - 7.5 Seconds
(75)**



**Maximum - 9.9 Seconds
(99)**

Host Character Timeout

Parameter # 239

SSI # EFh

Scan one of the following barcodes to specify the maximum time the scanner waits between characters transmitted by the host before discarding the received data and declaring an error.



NOTE: Other values are available via SSI commands.



*** Low - 200 msec
(20)**



**Medium - 500 msec
(50)**



**High - 750 msec
(75)**



**Maximum - 990 msec
(99)**

Multipacket Option

Parameter # 334

SSI # F0h 4Eh

Scan one of the following barcodes to control ACK/NAK handshaking for multi-packet transmissions:

- **Multi-Packet Option 1** - The host sends an ACK/NAK for each data packet during a multi-packet transmission.
- **Multi-Packet Option 2** - The scanner sends data packets continuously, with no ACK/NAK handshaking to pace the transmission. The host, if overrun, can use hardware handshaking to temporarily delay scanner transmissions. At the end of transmission, the scanner waits for a CMD_ACK or CMD_NAK.
- **Multi-Packet Option 3** - This is the same as option 2 with the addition of a programmable interpacket delay. See [Interpacket Delay on page 277](#) to set this delay.



* Multipacket Option 1
(0)



Multipacket Option 2
(1)



Multipacket Option 3
(2)

Interpacket Delay

Parameter # 335

SSI # F0h 4Fh

Scan one of the following barcodes to specify the interpacket delay if you selected **Multipacket Option 3**.



NOTE: Other values are available via SSI commands.



*** Minimum - 0 msec
(0)**



**Low - 25 msec
(25)**



**Medium - 50 msec
(50)**



**High - 75 msec
(75)**



**Maximum - 99 msec
(99)**

Event Reporting

The host can request the scanner to provide certain information (events) relative to scanner behavior. Scan the following barcodes to enable or disable the events listed in [Table 21](#) and on the following pages.

Table 21 Event Codes

Event Class	Event	Code Reported
Decode Event	Non-parameter decode	0x01
Boot Up Event	System power-up	0x03
Parameter Event	Parameter entry error	0x07
	Parameter stored	0x08
	Defaults set (and parameter event is enabled by default)	0x0A
	Number expected	0x0F

Decode Event

Parameter # 256

SSI # F0h 00h

Scan one of the following barcodes to enable or disable Decode Event.

- **Enable Decode Event** - The scanner generates a message to the host upon a successful barcode decode.
- **Disable Decode Event** - No notification is sent.

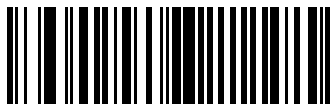

**Enable Decode Event
(1)**



*** Disable Decode Event
(0)**

Boot Up Event

Parameter # 258

SSI # F0h 02h

Scan one of the following barcodes to enable or disable Boot Up Event:

- **Enable Boot Up Event** - The scanner generates a message to the host whenever power is applied.
- **Disable Boot Up Event** - No notification is sent.

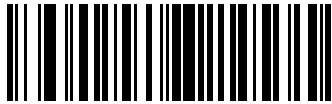

**Enable Boot Up Event
(1)**



*** Disable Boot Up Event
(0)**

Parameter Event

Parameter # 259

SSI # F0h 03h

Scan one of the following barcodes to enable or disable Parameter Event:

- **Enable Parameter Event** - The scanner generates a message to the host when one of the events specified in [Table 21 on page 278](#) occurs.
- **Disable Parameter Event** - No notification is sent.

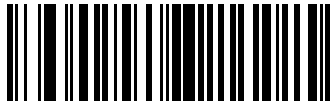

**Enable Parameter Event
(1)**



*** Disable Parameter Event
(0)**

RS-232 Interface

Introduction

This chapter describes how to set up the scanner with an RS-232 host. The scanner uses the RS-232 interface to connect to point-of-sale devices, host computers, or other devices with an available RS-232 port (e.g., com port).

The scanner ships with the settings shown in [Table 22 on page 283](#) (also see [Parameter Defaults](#) for all defaults). If the default values suit requirements, programming is not necessary.

If your host does not appear in [Table 23](#), refer to the documentation for the host device to set communication parameters to match the host.



NOTE: The scanner uses TTL RS-232 signal levels, which interface with most system architectures. For system architectures requiring RS-232C signal levels, Zebra offers different cables providing TTL-to-RS-232C conversion. Contact support for more information.

Setting Parameters

To set feature values, scan a single barcode or a short barcode sequence. The settings are stored in non-volatile memory and are preserved even when the scanner powers down.



NOTE: Most computer monitors allow scanning barcodes directly on the screen. When scanning from the screen, be sure to set the document magnification to a level where you can see the barcode clearly, and bars and/or spaces do not merge.

To return all features to default values, scan [Set Factory Defaults on page 62](#). Throughout the programming barcode menus, asterisks (*) indicate default values.



* Indicates default * Enable Parameter Feature/option

Scanning Sequence Examples

In most cases scanning one barcode sets the parameter value. For example, to set the baud rate to 19,200, scan the **Baud Rate 19,200** barcode under [Baud Rate on page 288](#). The scanner issues a fast warble beep and the LED turns green, signifying a successful parameter entry.

Other parameters require scanning several barcodes. See the parameter descriptions for this procedure.

Errors While Scanning

Unless otherwise specified, to correct an error during a scanning sequence, just re-scan the correct parameter.

Connecting an RS-232 Interface

Connect the scanner directly to the host computer.

Figure 20 RS-232 Connection

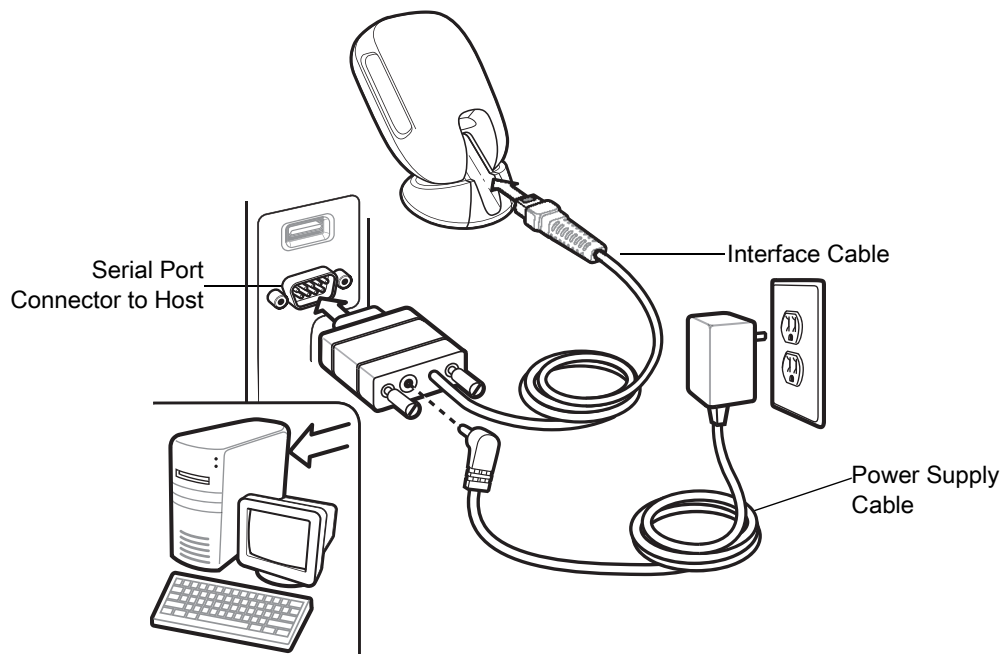

1. Attach the modular connector of the RS-232 interface cable to the cable interface port on the scanner. See [Inserting the Interface Cable on page 31](#).



NOTE: Interface cables vary depending on configuration. The connectors can be different than those illustrated in [Figure 1](#), but the steps to connect the scanner are the same.

2. Connect the other end of the RS-232 interface cable to the serial port on the host.
3. If required, connect the power supply to the serial connector end of the RS-232 interface cable. Plug the power supply into an appropriate outlet.
4. The scanner automatically detects the host interface type and uses the default setting. If the default (*) does not meet your requirements, select another RS-232 host type by scanning the appropriate barcode from [RS-232 Host Types on page 286](#).
5. To modify any other parameter options, scan the appropriate barcodes in this chapter.

If problems occur with the system, see [Troubleshooting on page 51](#).

RS-232 Parameter Defaults

Table 22 lists defaults for RS-232 host parameters. Change these values in one of two ways:

- Scan the appropriate barcodes in this chapter. The new value replaces the standard default value in memory. To recall default parameter values, see [Default Parameters on page 62](#).
- Configure the scanner using the 123Scan configuration program. See [123Scan and Software Tools](#).



NOTE: See [Parameter Defaults](#) for all user preference, host, symbology, and miscellaneous default parameters.

Table 22 RS-232 Interface Parameter Defaults

Parameter	Default	Page Number
RS-232 Host Parameters		
RS-232 Host Types	Standard	286
Baud Rate	9600	288
Parity	None	289
Stop Bits	1 Stop Bit	289
Data Bits	8-bit	290
Check Receive Errors	Enable	290
Hardware Handshaking	None	291
Software Handshaking	None	293
Host Serial Response Timeout	2 Seconds	295
RTS Line State	Low RTS	296
Beep on <BEL>	Disable	296
Intercharacter Delay	0 msec	297
Nixdorf Beep/LED Options	Normal Operation	298
Barcodes with Unknown Characters	Send Barcode With Unknown Characters	298

RS-232 Host Parameters

Various RS-232 hosts use their own parameter default settings. Selecting standard, ICL, Fujitsu, Wincor-Nixdorf Mode A, Wincor-Nixdorf Mode B, OPOS/JPOS, Olivetti, Omron, or Common Use Terminal Equipment (CUTE-LP/LG barcode readers) sets the defaults listed in [Table 23](#).

Table 23 Terminal Specific RS-232

Parameter	ICL	Fujitsu	Wincor-Nixdorf Mode A	Wincor-Nixdorf Mode B/OPOS/JPOS	Olivetti	Omron	CUTE
Transmit Code ID	Yes	Yes	Yes	Yes	Yes	Yes	Yes
Data Transmission Format	Data/Suffix	Data/Suffix	Data/Suffix	Data/Suffix	Prefix/Data/Suffix	Data/Suffix	Prefix/Data/Suffix
Suffix	CR (1013)	CR (1013)	CR (1013)	CR (1013)	ETX (1002)	CR (1013)	CR (1013) ETX (1003)
Baud Rate	9600	9600	9600	9600	9600	9600	9600
Parity	Even	None	Odd	Odd	Even	None	None
Hardware Handshaking	RTS/CTS Option 3	None	RTS/CTS Option 3	RTS/CTS Option 3	None	None	None
Software Handshaking	None	None	None	None	ACK/NAK	None	None
Serial Response Timeout	9.9 Sec.	2 Sec.	None	None	9.9 Sec.	9.9 Sec.	9.9 Sec.
Stop Bit Select	One	One	One	One	One	One	One
ASCII Format	8-Bit	8-Bit	8-Bit	8-Bit	7-Bit	8-Bit	8-Bit
Beep On <BEL>	Disable	Disable	Disable	Disable	Disable	Disable	Disable

In the Wincor-Nixdorf Mode A/B, if CTS is low, scanning is disabled. When CTS is high, scanning is enabled.

If you scan Wincor-Nixdorf RS-232 Mode A/B without connecting the scanner to the proper host, it may appear unable to scan. If this happens, scan a different RS-232 host type within 5 seconds of cycling power to the scanner.

The CUTE host disables all parameter scanning, including Set Defaults. If you inadvertently select CUTE, scan [* Enable Parameter Barcode Scanning \(1\) on page 63](#), then change the host selection.

Table 23 Terminal Specific RS-232 (Continued)

Parameter	ICL	Fujitsu	Wincor-Nixdorf Mode A	Wincor-Nixdorf Mode B/OPOS/JPOS	Olivetti	Omron	CUTE
RTS Line State	High	Low	Low	Low = No data to send	Low	High	High
Prefix	None	None	None	None	STX (1003)	None	STX (1002)

In the Wincor-Nixdorf Mode A/B, if CTS is low, scanning is disabled. When CTS is high, scanning is enabled. If you scan Wincor-Nixdorf RS-232 Mode A/B without connecting the scanner to the proper host, it may appear unable to scan. If this happens, scan a different RS-232 host type within 5 seconds of cycling power to the scanner.

The CUTE host disables all parameter scanning, including Set Defaults. If you inadvertently select CUTE, scan [Enable Parameter Barcode Scanning \(1\) on page 63](#), then change the host selection.

Selecting ICL, Fujitsu, Wincor-Nixdorf Mode A, Wincor-Nixdorf Mode B, OPOS/JPOS, Olivetti, Omron, or CUTE-LP/LG barcode readers transmits the code ID characters listed in [Table 24](#). These code ID characters are not programmable and are separate from the Transmit Code ID feature. Do not enable the Transmit Code ID feature for these terminals.

Table 24 Terminal Specific Code ID Characters

Code Type	ICL	Fujitsu	Wincor-Nixdorf Mode A	Wincor-Nixdorf Mode B/OPOS/JPOS	Olivetti	Omron	CUTE
UPC-A	A	A	A	A	A	A	A
UPC-E	E	E	C	C	C	E	None
EAN-8/JAN-8	FF	FF	B	B	B	FF	None
EAN-13/JAN-13	F	F	A	A	A	F	A
Code 39	C <len>	None	M	M	M <len>	C <len>	3
Code 39 Full ASCII	None	None	M	M	None	None	3
Codabar	N <len>	None	N	N	N <len>	N <len>	None
Code 128	L <len>	None	K	K	K <len>	L <len>	5
I 2 of 5	I <len>	None	I	I	I <len>	I <len>	1
Code 93	None	None	L	L	L <len>	None	None
D 2 of 5	H <len>	None	H	H	H <len>	H <len>	2
GS1-128	L <len>	None	P	P	P <len>	L <len>	5
MSI	None	None	O	O	O <len>	None	None
Bookland EAN	F	F	A	A	A	F	None
Trioptic	None	None	None	None	None	None	None
Code 11	None	None	None	None	None	None	None

Table 24 Terminal Specific Code ID Characters (Continued)

Code Type	ICL	Fujitsu	Wincor-Nixdorf Mode A	Wincor-Nixdorf Mode B/ OPOS/JPOS	Olivetti	Omron	CUTE
IATA	H<len>	None	H	H	H<len>	H<len>	2
Code 32	None	None	None	None	None	None	None
GS1 DataBar Variants	None	None	E	E	None	None	None
PDF417	None	None	Q	Q	None	None	6
Data Matrix	None	None	R	R	None	None	4
GS1 Data Matrix	None	None	W	W	None	None	None
QR Codes	None	None	U	U	None	None	7
GS1 QR	None	None	X	X	None	None	None
Aztec/Aztec Rune	None	None	V	V	None	None	8
Maxicode	None	None	T	T	None	None	None
MicroPDF	None	None	S	S	None	None	6

RS-232 Host Types

To select an RS-232 host interface, scan one of the following barcodes.



NOTE: For a list of supported scanner functionality by communication protocol, see [Communication Protocol Functionality](#).

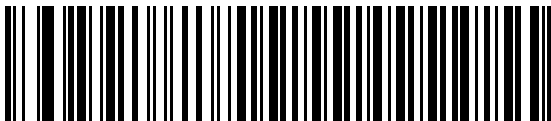

* Standard RS-232¹

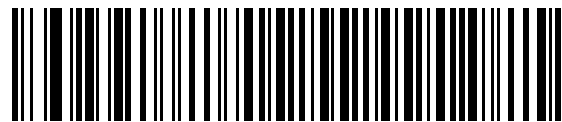

ICL RS-232

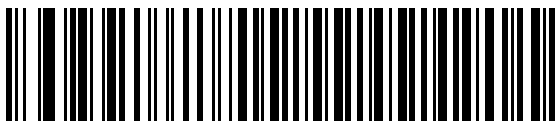

Wincor-Nixdorf RS-232 Mode A

RS-232 Host Types (continued)



Wincor-Nixdorf RS-232 Mode B

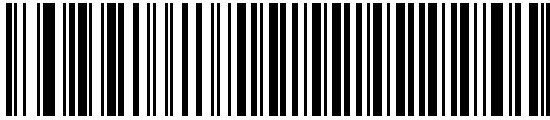

Olivetti ORS4500

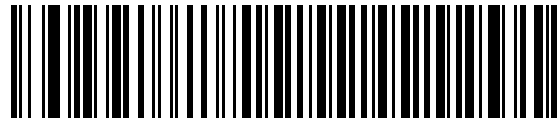

Omron

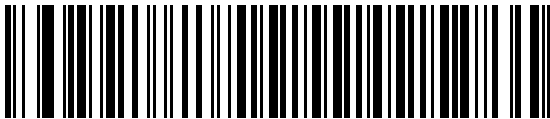

OPOS/JPOS

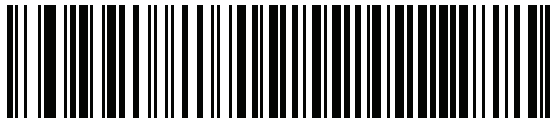

Fujitsu RS-232

CUTE²

¹Scanning Standard RS-232 activates the RS-232 driver, but does not change port settings (e.g., parity, data bits, handshaking). Selecting another RS-232 host type barcode changes these settings.

²The CUTE host disables all parameter scanning, including Set Defaults. If you inadvertently select CUTE, scan [* Enable Parameter Barcode Scanning \(1\) on page 63](#), and then change the host selection.

Baud Rate

Baud rate is the number of bits of data transmitted per second. Scan one of the following barcodes to set the scanner's baud rate to match the baud rate setting of the host device. Otherwise, data may not reach the host device or may reach it in distorted form.

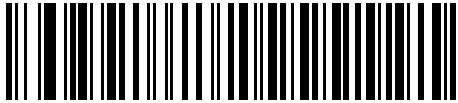

Baud Rate 4800



*** Baud Rate 9600**



Baud Rate 19,200



Baud Rate 38,400



Baud Rate 57,600



Baud Rate 115,200

Parity

A parity check bit is the most significant bit of each ASCII coded character. Scan one of the following barcodes to select the parity type according to host device requirements:

- **Odd** - This sets the parity bit value to 0 or 1, based on data, to ensure that the coded character contains an odd number of 1 bits.
- **Even** - This sets the parity bit value to 0 or 1, based on data, to ensure that the coded character contains an even number of 1 bits.
- **None** - No parity bit is required.

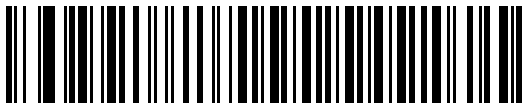

Odd

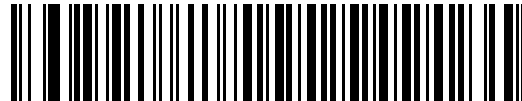

Even



*** None**

Stop Bits

The stop bit(s) at the end of each transmitted character marks the end of transmission of one character and prepares the receiving device for the next character in the serial data stream. Scan one of the following barcodes to set the number of stop bits (one or two) based on the number the receiving host can accommodate.



*** 1 Stop Bit**



2 Stop Bits

Data Bits

This parameter allows the scanner to interface with devices requiring a 7-bit or 8-bit ASCII protocol.



7-bit



* 8-bit

Check Receive Errors

Scan one of the following barcodes to set whether to check the parity, framing, and overrun of received characters. The parity value of received characters is verified against the value set for [Parity on page 289](#).

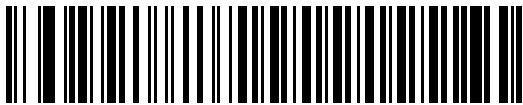

* Check For Received Errors



Do Not Check For Received Errors

Hardware Handshaking

The data interface consists of an RS-232 port designed to operate either with or without the hardware handshaking lines Request to Send (RTS) and Clear to Send (CTS).

If hardware handshaking and software handshaking are both enabled, hardware handshaking takes precedence.



NOTE: The DTR signal is jumpered to the active state.

Options:

- **None** - This disables hardware handshaking and transmits scan data as it becomes available.
- **Standard RTS/CTS** - This sets standard RTS/CTS hardware handshaking and transmits scanned data according to the following sequence:
 - a. The scanner reads the CTS line for activity:
 - If the CTS line is de-asserted, the scanner asserts the RTS line and waits up to [Host Serial Response Timeout on page 295](#) for the host to assert CTS, and then transmits data when asserted. If, after the timeout, the CTS line is not asserted, the scanner sounds a transmit error and discards the data.
 - If CTS is asserted, the scanner waits up to [Host Serial Response Timeout](#) for the host to de-assert CTS. If after this timeout the CTS line is still asserted, the scanner sounds a transmit error and discards the scanned data.
 - b. The scanner de-asserts RTS after sending the last character of data.
 - c. The host negates CTS. The scanner checks for a de-asserted CTS upon the next data transmission.

During data transmission, if CTS is deasserted for more than 50 ms between characters, the scanner sounds a transmit error and discards the data. The data must be re-scanned.

- **RTS/CTS Option 1** - The scanner asserts RTS before transmitting and ignores the state of CTS. The scanner de-asserts RTS when transmission completes.
- **RTS/CTS Option 2** - RTS is always high or low (user-programmed logic level). However, the scanner waits for the host to assert CTS before transmitting data. If CTS is not asserted within the [Host Serial Response Timeout](#), the scanner sounds a transmit error and discards the data. During data transmission, if CTS is deasserted for more than 50 ms between characters, the scanner sounds a transmit error and discards the data.
- **RTS/CTS Option 3** - This transmits scanned data according to the following sequence:
 - d. The scanner asserts RTS before data transmission, regardless of the state of CTS.
 - e. The scanner waits up to the [Host Serial Response Timeout](#) for the host to assert CTS, and then transmits data when asserted. If, after the timeout, the CTS line is not asserted, the scanner sounds a transmit error and discards the data.
 - f. The scanner de-asserts RTS after sending the last character of data.
 - g. The host negates CTS. The scanner checks for a de-asserted CTS upon the next data transmission.

During data transmission, if CTS is deasserted for more than 50 ms between characters, the scanner sounds a transmit error and discards the data. The data must be re-scanned.

Hardware Handshaking (continued)

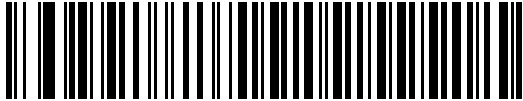

*** None**



Standard RTS/CTS



RTS/CTS Option 1



RTS/CTS Option 2



RTS/CTS Option 3

Software Handshaking

This parameter offers control of data transmission in addition to, or instead of, that offered by hardware handshaking. If software handshaking and hardware handshaking are both enabled, hardware handshaking takes precedence.

Options:

- **None** - This transmits data immediately. The scanner expects no response from the host.
- **ACK/NAK** - After transmitting data, the scanner waits for an ACK or NAK response from the host. If it receives a NAK, the scanner transmits the data again and waits for an ACK or NAK. After three unsuccessful attempts to send data after receiving NAKs, the scanner sounds a transmit error and discards the data.

The scanner waits up to the programmable [Host Serial Response Timeout](#) to receive an ACK or NAK. If the scanner does not get a response in this time, it sounds a transmit error and discards the data. There are no reattempts.

- **ENQ** - The scanner waits for an ENQ character from the host before transmitting data. If it does not receive an ENQ within the [Host Serial Response Timeout](#), the scanner sounds a transmit error and discards the data. The host must transmit an ENQ character at least every [Host Serial Response Timeout](#) to prevent transmission errors.
- **ACK/NAK with ENQ** - This combines the two previous options. An additional ENQ is not required to re-transmit data due to a NAK from the host.
- **XON/XOFF** - An XOFF character stops data transmission until the scanner receives an XON character. There are two situations for XON/XOFF:
 - The scanner receives an XOFF before it has data to send. When the scanner has data, it waits up to the [Host Serial Response Timeout](#) for an XON character before transmitting. If it does not receive the XON within this time, the scanner sounds a transmit error and discards the data.
 - The scanner receives an XOFF during data transmission and stops transmission after sending the current byte. When the scanner receives an XON character, it sends the rest of the data. The scanner waits indefinitely for the XON.

Software Handshaking (continued)

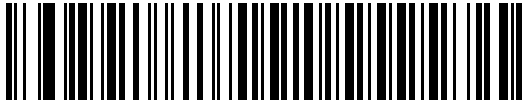

* None



ACK/NAK

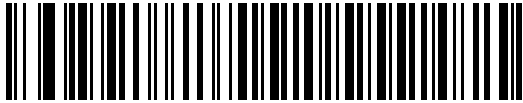

ENQ

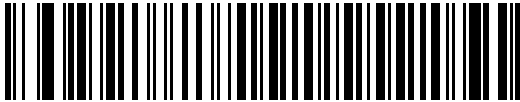

ACK/NAK with ENQ

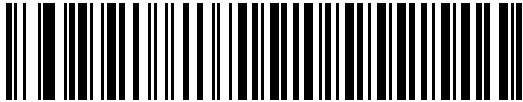

XON/XOFF

Host Serial Response Timeout

Scan one of the following barcodes to specify how long the scanner waits for an ACK, NAK, or CTS before determining that a transmission error occurred. This only applies when in one of the ACK/NAK software handshaking modes, or RTS/CTS hardware handshaking mode.



*** Minimum: 2 Seconds**



Low: 2.5 Seconds

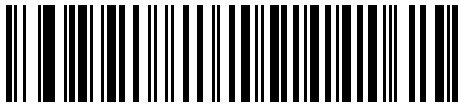

Medium: 5 Seconds



High: 7.5 Seconds

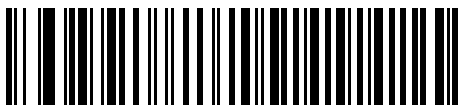

Maximum: 9.9 Seconds

RTS Line State

Scan one of the following barcodes to set the idle state of the serial host RTS line to **Low RTS** or **High RTS**.

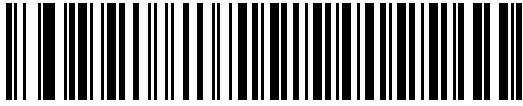

* Host: Low RTS

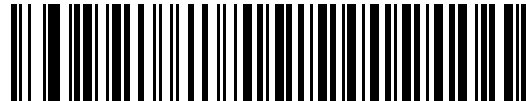

Host: High RTS

Beep on <BEL>

Scan one of the following barcodes to set whether the scanner issues a beep when it detects a <BEL> character on the RS-232 serial line. <BEL> indicates an illegal entry or other important event.

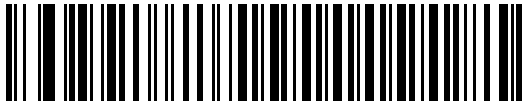

Beep On <BEL> Character
(Enable)

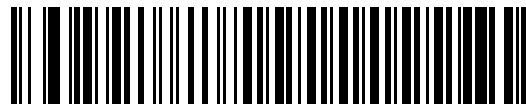

* Do Not Beep On <BEL> Character
(Disable)

Intercharacter Delay

Scan one of the following barcodes to specify the intercharacter delay inserted between character transmissions.



*** Minimum: 0 msec**



Low: 25 msec



Medium: 50 msec



High: 75 msec

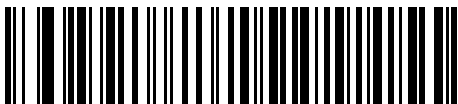

Maximum: 99 msec

Nixdorf Beep/LED Options

If you selected Nixdorf Mode B, scan one of the following barcodes to indicate when the scanner beeps and turns on its LED after a decode.



*** Normal Operation**
(Beep/LED Immediately After Decode)

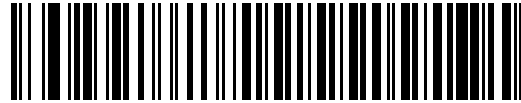

Beep/LED After Transmission



Beep/LED After CTS Pulse

Barcodes with Unknown Characters

Unknown characters are characters the host does not recognize. Scan **Send Barcodes With Unknown Characters** to send all barcode data except for unknown characters. The scanner issues no error beeps.

Scan **Do Not Send Barcodes With Unknown Characters** to send barcode data up to the first unknown character. The scanner issues an error beep.

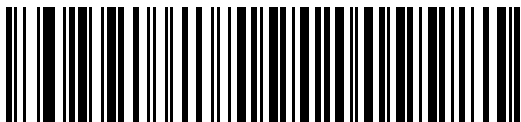

*** Send Barcodes With Unknown Characters**

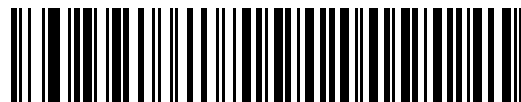

Do Not Send Barcodes With Unknown Characters

ASCII Character Sets

See ASCII Character Set, [Table 33 on page 460](#), for prefix/suffix values

IBM Interface

Introduction

This chapter describes how to set up the scanner with an IBM 468X/469X host.

The scanner ships with the settings shown in [Table 25 on page 302](#) (also see [Parameter Defaults](#) for all defaults). If the default values suit requirements, programming is not necessary.

Setting Parameters

To set feature values, scan a single barcode or a short barcode sequence. The settings are stored in non-volatile memory and are preserved even when the scanner powers down.



NOTE: Most computer monitors allow scanning barcodes directly on the screen. When scanning from the screen, be sure to set the document magnification to a level where you can see the barcode clearly, and bars and/or spaces do not merge.

To return all features to default values, scan [Set Factory Defaults on page 62](#). Throughout the programming barcode menus, asterisks (*) indicate default values.



* Indicates default * Enable Parameter Feature/option

Scanning Sequence Examples

In most cases scanning one barcode sets the parameter value. For example, to select the Port 9B address, scan the **Hand-held Scanner Emulation (Port 9B)** barcode under [Port Address on page 303](#). The scanner issues a fast warble beep and the LED turns green, signifying a successful parameter entry.

Other parameters require scanning several barcodes. See the parameter descriptions for this procedure.

Errors While Scanning

Unless otherwise specified, to correct an error during a scanning sequence, just re-scan the correct parameter.

Connecting an IBM 468X/469X Host

Connect the scanner directly to the host computer.

Figure 21 IBM Connection

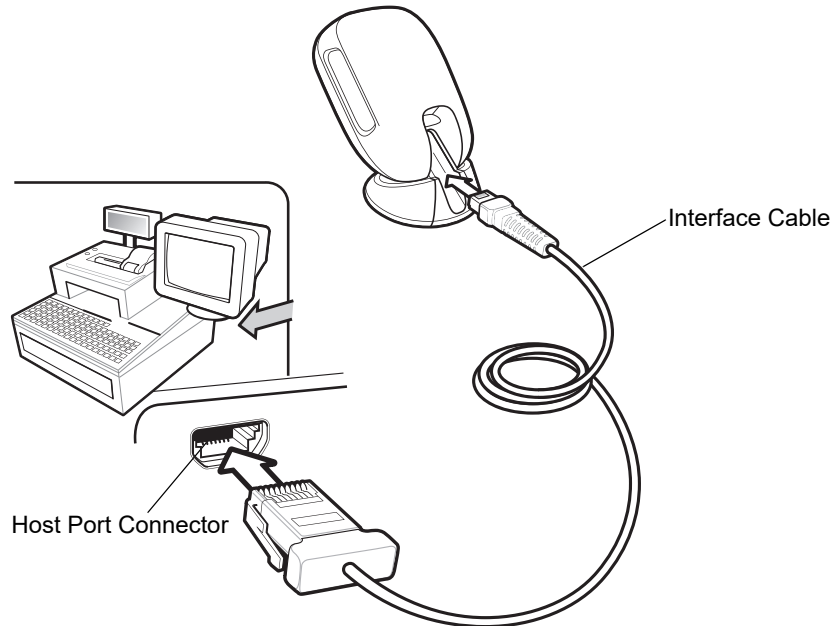

1. Attach the modular connector of the IBM 46XX interface cable to the cable interface port on the scanner. See [Inserting the Interface Cable on page 31](#).



NOTE: Interface cables vary depending on configuration. The connectors can be different than those illustrated in [Figure 21](#), but the steps to connect the scanner are the same.

2. Connect the other end of the IBM 46XX interface cable to the appropriate port on the host (ly Port 9).
3. The scanner automatically detects the host interface type, but there is no default setting. Scan the appropriate barcode from [Port Address on page 303](#) to select the port address.
4. To modify any other parameter options, scan the appropriate barcodes in this chapter.



NOTE: The only required configuration is the port address. The IBM system ly controls other scanner parameters.

If problems occur with the system, see [Troubleshooting on page 51](#).

IBM Parameter Defaults

Table 25 lists defaults for IBM host parameters. Change these values in one of two ways:

- Scan the appropriate barcodes in this chapter. The new value replaces the standard default value in memory. To recall default parameter values, see [Default Parameters on page 62](#).
- Configure the scanner using the 123Scan configuration program. See [123Scan and Software Tools](#).



NOTE: See [Parameter Defaults](#) for all user preference, host, symbology, and miscellaneous default parameters.

Table 25 IBM 468X/469X Interface Parameter Defaults

Parameter	Default	Page Number
IBM 468X/469X Host Parameters		
Port Address	None	303
Convert Unknown to Code 39	Disable	304
RS-485 Beep Directive	Ignore	304
RS-485 Barcode Configuration Directive	Ignore	305
IBM-485 Specification Version	Original Specification	305

IBM Host Parameters

Port Address

Scan one of the following barcodes to select the IBM 468X/469X port.



NOTE: Scanning a Port Address barcode enables the RS-485 interface on the scanner.



NOTE: For a list of supported scanner functionality by communication protocol, see [Communication Protocol Functionality](#).

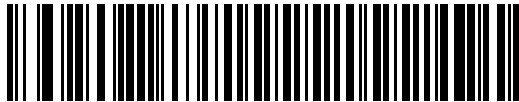

* None



Hand-held Scanner Emulation (Port 9B)

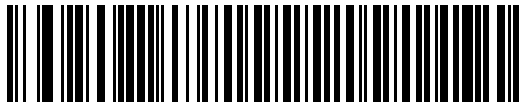

Non-IBM Scanner Emulation (Port 5B)

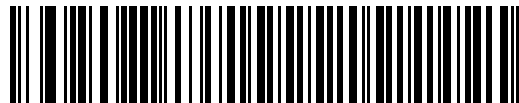

Table-top Scanner Emulation (Port 17)

Convert Unknown to Code 39

Scan one of the following barcodes to enable or disable converting unknown barcode type data to Code 39.



Enable Convert Unknown to Code 39



*** Disable Convert Unknown to Code 39**

RS-485 Beep Directive

The IBM RS-485 host can send a beep configuration request to the scanner. Scan **Ignore Beep Directive** to prevent the scanner from processing the host request. All directives are still acknowledged to the host as if they were processed.

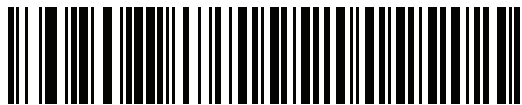

Honor Beep Directive



*** Ignore Beep Directive**

RS-485 Barcode Configuration Directive

The IBM RS-485 host can enable and disable code types. Scan **Ignore Barcode Configuration Directive** to prevent the scanner from processing the host request. All directives are still acknowledged to the IBM RS-485 host as if they were processed.

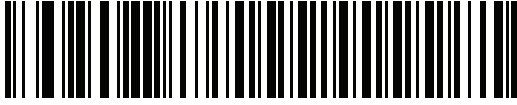

Honor Barcode Configuration Directive



*** Ignore Barcode Configuration Directive**

IBM-485 Specification Version

Parameter # 1729 (SSI # F8h 06h C1h)

The IBM interface specification version selected defines how code types are reported over the IBM interface.

When you scan **Original Specification**, only Symbologies that were historically supported on each individual port are reported as known. When you scan Version 2.0, all Symbologies covered in the newer IBM specification are reported as known with their respective code types.



*** Original Specification
(0)**



**Version 2.0
(1)**

Keyboard Wedge Interface

Introduction

This chapter describes how to set up a keyboard wedge interface with the scanner. The scanner connects between the keyboard and host computer and translates barcode data into keystrokes, which the host accepts as if they originated from the keyboard. This mode adds barcode reading functionality to a system designed for manual keyboard input. Keyboard keystrokes are simply passed through.

The scanner ships with the settings shown in [Table 26 on page 308](#) (also see [Parameter Defaults](#) for all defaults). If the default values suit requirements, programming is not necessary.

Setting Parameters

To set feature values, scan a single barcode or a short barcode sequence. The settings are stored in non-volatile memory and are preserved even when the scanner powers down.



NOTE: Most computer monitors allow scanning barcodes directly on the screen. When scanning from the screen, be sure to set the document magnification to a level where you can see the barcode clearly, and bars and/or spaces do not merge.

To return all features to default values, scan a barcode in [Default Parameters on page 62](#). Throughout the programming barcode menus, asterisks (*) indicate default values.



* Indicates default * Enable Parameter Feature/option

Scanning Sequence Examples

In most cases, scanning one barcode sets the parameter value. For example, to select a medium keystroke delay, scan the **Medium Delay (20 msec)** barcode under [Keystroke Delay on page 310](#). The scanner issues a fast warble beep and the LED turns green, signifying a successful parameter entry.

Other parameters require scanning several barcodes. See the parameter descriptions for this procedure.

Errors While Scanning

Unless otherwise specified, to correct an error during a scanning sequence, just re-scan the correct parameter.

Connecting a Keyboard Wedge Interface

Figure 22 Keyboard Wedge Connection

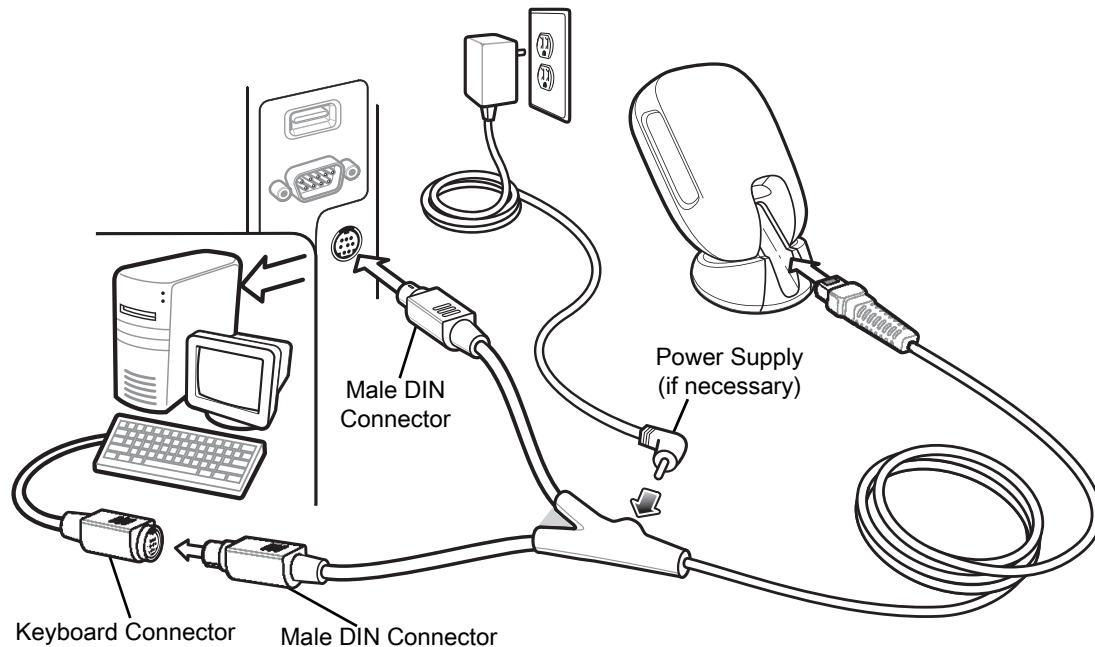

NOTE: Interface cables vary depending on configuration. The connectors can be different than those illustrated in Figure 22, but the steps to connect the scanner are the same.

1. Turn off the host and unplug the keyboard connector.
2. Attach the modular connector of the Y-cable to the cable interface port on the scanner. See [Inserting the Interface Cable on page 31](#).
3. Connect the round male DIN host connector of the Y-cable to the keyboard port on the host device.
4. Connect the round female DIN keyboard connector of the Y-cable to the keyboard connector.
5. If required, attach the optional power supply to the connector in the middle of the Y-cable.
6. Ensure that all connections are secure.
7. Turn on the host system.
8. The scanner automatically detects the host interface type and uses the default setting. If the default (*) does not meet your requirements, scan [IBM PC/AT & IBM PC Compatibles on page 309](#).
9. To modify other parameter options, scan the appropriate barcodes in this guide.

If problems occur with the system, see [Troubleshooting on page 51](#).

Keyboard Wedge Parameter Defaults

Table 26 lists defaults for keyboard wedge host parameters. Change these values in one of two ways:

- Scan the appropriate barcodes in this chapter. The new value replaces the standard default value in memory. To recall default parameter values, see [Default Parameters on page 62](#).
- Configure the scanner using the 123Scan configuration program. See [123Scan and Software Tools](#).



NOTE: See [Parameter Defaults](#) for all user preference, host, symbology, and miscellaneous default parameters.

Table 26 Keyboard Wedge Interface Parameter Defaults

Parameter	Default	Page Number
Keyboard Wedge Host Parameters		
Keyboard Wedge Host Type	IBM AT Notebook	309
Barcodes with Unknown Characters	Send Barcodes with Unknown Characters	309
Keystroke Delay	No Delay	310
Intra-keystroke Delay	Disable	310
Alternate Numeric Keypad Emulation	Enable	311
Quick Keypad Emulation	Enable	311
Simulated Caps Lock	Disable	312
Caps Lock Override	Disable	313
Convert Case	Do Not Convert	313
Function Key Mapping	Disable	314
FN1 Substitution	Disable	314
Send Make and Break	Send Make and Break Scan Codes	315

Keyboard Wedge Host Parameters

Keyboard Wedge Host Types

Scan one of the following barcodes to select the keyboard wedge host.



NOTE: For a list of supported scanner functionality by communication protocol, see [Communication Protocol Functionality](#).

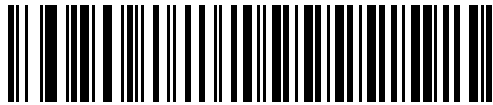

IBM PC/AT & IBM PC Compatibles

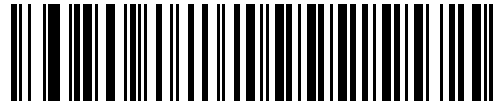

*** IBM AT Notebook**

Barcodes with Unknown Characters

Unknown characters are characters the host does not recognize. Scan **Send Barcodes With Unknown Characters** to send all barcode data except for unknown characters. The scanner issues no error beeps.

Scan **Do Not Send Barcodes With Unknown Characters** to send barcode data up to the first unknown character. The scanner issues an error beep.

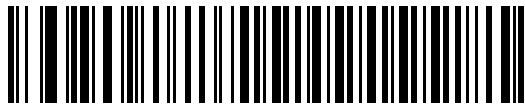

***Send Barcodes with Unknown Characters**



Do Not Send Barcodes with Unknown Characters

Keystroke Delay

This is the delay in milliseconds between emulated keystrokes. Scan one of the following barcodes to increase the delay when hosts require a slower data transmission.



* No Delay



Medium Delay (20 msec)

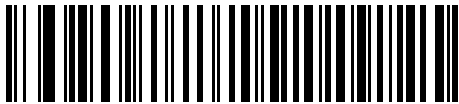

Long Delay (40 msec)

Intra-keystroke Delay

Scan **Enable Intra-keystroke Delay** to insert an additional delay between each emulated key press and release. This also sets [Keystroke Delay](#) to a minimum of 5 msec.

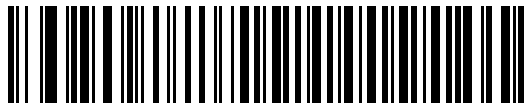

Enable Intra-keystroke Delay

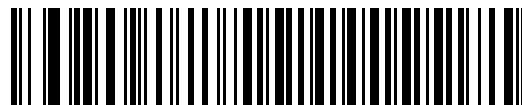

* Disable Intra-keystroke Delay

Alternate Numeric Keypad Emulation

This allows emulation of most other country keyboard types not listed in [Country Codes](#) in a Microsoft® operating system environment.



NOTE: If your keyboard type is not listed in the country code list (see [Country Codes](#)), disable [Quick Keypad Emulation on page 311](#) and ensure [Alternate Numeric Keypad Emulation on page 311](#) is enabled.

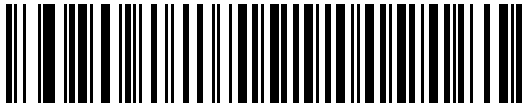

* Enable Alternate Numeric Keypad

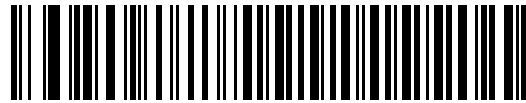

Disable Alternate Numeric Keypad

Quick Keypad Emulation

This enables faster keypad emulation where character value sequences are only sent for characters not found on the keyboard.



NOTE: This option applies only when [Alternate Numeric Keypad Emulation](#) is enabled.



* Enable Quick Keypad Emulation



Disable Quick Keypad Emulation

Simulated Caps Lock

Scan **Enable Caps Lock** to invert upper and lower case characters on the barcode as if the Caps Lock state is enabled on the keyboard. This inversion occurs regardless of the keyboard's Caps Lock state. Note that this only applies to alpha characters.



- NOTES:** - Simulated Caps Lock applies to ASCII characters only.
- Do not enable this parameter if either of the following parameters are enabled:
[Convert to Upper Case on page 313](#)
[Convert to Lower Case on page 313](#)



Enable Caps Lock

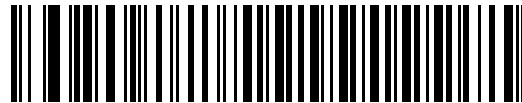

*** Disable Caps Lock**

Caps Lock Override

Scan **Enable Caps Lock Override** for AT or AT Notebook hosts to preserve the case of the data regardless of the state of the Caps Lock key. Therefore, an 'A' in the barcode transmits as an 'A' regardless of the setting of the keyboard's Caps Lock key.



NOTE: If both Simulated Caps Lock and Caps Lock Override are enabled, Caps Lock Override takes precedence.



Enable Caps Lock Override

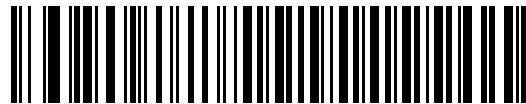

*** Disable Caps Lock Override**

Convert Case

Scan one of the following barcodes to convert all barcode data to the selected case.



NOTE: Convert Case applies to ASCII characters only.



Convert to Upper Case

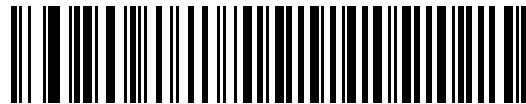

Convert to Lower Case



*** Do Not Convert**

Function Key Mapping

ASCII values under 32 are normally sent as control key sequences (see [Table 33 on page 460](#)). Scan **Enable Function Key Mapping** to send the keys in bold in place of the standard key mapping. Table entries that do not have a bold entry remain the same whether or not you enable this parameter.



Enable Function Key Mapping

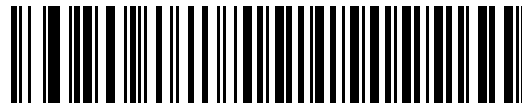

*** Disable Function Key Mapping**

FN1 Substitution

Scan **Enable FN1 Substitution** to replace FN1 characters in an EAN128 barcode with a user-selected keystroke (see [FN1 Substitution Values on page 93](#)).



Enable FN1 Substitution

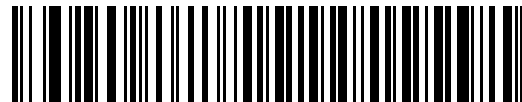

*** Disable FN1 Substitution**

Send Make and Break

Scan **Send Make and Break Scan Codes** to prevent sending the scan codes for releasing a key.



NOTE: Windows-based systems must use **Send Make and Break Scan Codes**.

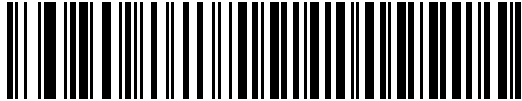

* **Send Make and Break Scan Codes**

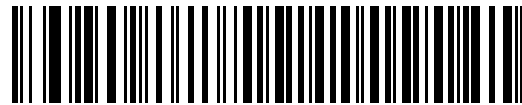

Send Make Scan Code Only

Keyboard Map

The following keyboard map is a reference for prefix/suffix keystroke parameters. To program the prefix/suffix values, see [Prefix/Suffix Values on page 90](#).

Figure 23 IBM PS2 Type Keyboard

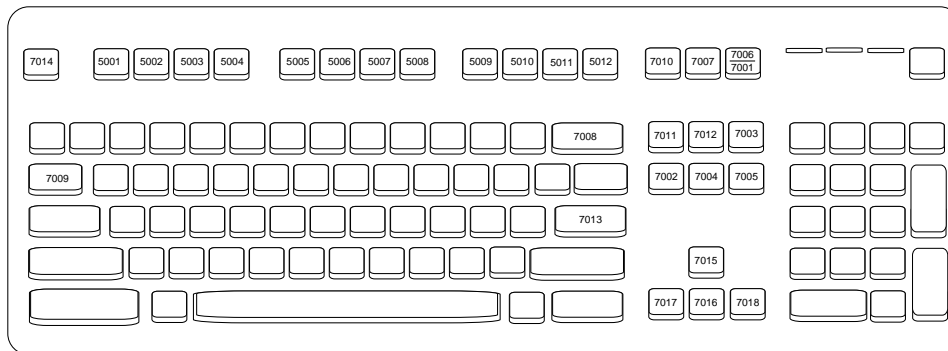

ASCII Character Sets

See [ASCII Character Sets](#) for the following information:

- ASCII Character Set, [Table 33 on page 460](#)
- ALT Key Character Set, [Table 34 on page 465](#)
- GUI Key Character Set, [Table 35 on page 466](#)
- PF Key Character Set, [Table 36 on page 467](#)
- F Key Character Set, [Table 37 on page 468](#)
- Numeric Key Character Set, [Table 38 on page 468](#)
- Extended Key Character Set, [Table 39 on page 469](#)

OCR Programming

Introduction

This chapter describes how to set up the scanner for OCR programming. The scanner can read 6 to 60 point OCR typeface. It supports font types OCR-A, OCR-B, MICR E13B, and US Currency Serial Number.

OCR is not as secure as a barcode. To decrease OCR misdecodes and speed OCR reading, set an accurate OCR template and character subset, and use a check digit.

All OCR fonts are disabled by default. Enabling OCR could slow barcode decoding. You can enable OCR-A and OCR-B at the same time, but not other combined font types.

Setting Parameters

To set feature values, scan a single barcode or a short barcode sequence. The settings are stored in non-volatile memory and are preserved even when the imager powers down.



NOTE: Most computer monitors allow scanning barcodes directly on the screen. When scanning from the screen, be sure to set the document magnification to a level where you can see the barcode clearly, and bars and/or spaces do not merge.

To return all features to default values, scan the [Set Factory Defaults on page 62](#). Throughout the programming barcode menus, asterisks (*) indicate default values.



* Indicates default * Enable Parameter Feature/option
(1) Option value

Scanning Sequence Examples

In most cases scanning one barcode sets the parameter value. For example, to enable OCR-B, scan the **Enable OCR-B** barcode under [OCR-B on page 321](#). The scanner issues a fast warble beep and the LED turns green, signifying a successful parameter entry.

Other parameters require scanning several barcodes. See the parameter descriptions for this procedure.

Errors While Scanning

Unless otherwise specified, to correct an error during a scanning sequence, just re-scan the correct parameter.

OCR Parameter Defaults

[Table 27](#) lists the defaults for OCR parameters. Change these values in one of two ways:

- Scan the appropriate barcodes in this chapter. The new value replaces the standard default value in memory. To recall default parameter values, see [Default Parameters on page 62](#).
- Configure the scanner using the 123Scan configuration program. See [123Scan and Software Tools](#).



NOTE: See [Parameter Defaults](#) for all user preference, host, symbology, and miscellaneous default parameters.

Table 27 OCR Programming Default Table

Parameter	Parameter Number	SSI Number	Default	Page Number
OCR Programming Parameters				
OCR-A	680	F1h A8h	Disable	319
OCR-A Variant	684	F1h ACh	OCR-A Full ASCII	320
OCR-B	681	F1h A9h	Disable	321
OCR-B Variant	685	F1h ADh	OCR-B Full ASCII	322
MICR E13B	682	F1h AAh	Disable	326
US Currency Serial Number	683	F1h ABh	Disable	327
OCR Orientation	687	F1h AFh	0°	327
OCR Lines	691	F1h B3h	1	329
OCR Minimum Characters	689	F1h B1h	3	329
OCR Maximum Characters	690	F1h B2h	100	330
OCR Subset	686	F1h AEh	Selected font variant	330
OCR Quiet Zone	695	F1h B7h	50	331

Table 27 OCR Programming Default Table (Continued)

Parameter	Parameter Number	SSI Number	Default	Page Number
OCR Template	547	F1h 23h	99999999	331
OCR Check Digit Modulus	688	F1h B0h	1	341
OCR Check Digit Multiplier	700	F1h BCh	121212121212	341
OCR Check Digit Validation	694	F1h B6h	None	342
Inverse OCR	856	F2h 58h	Regular	348
OCR Redundancy	1770	F8h 06h EAh	Level 1	349

OCR Programming Parameters

OCR-A

Parameter # 680

SSI # F1h A8h



NOTE: OCR is not as secure as a barcode. To decrease OCR misdecodes and speed OCR reading, set an accurate OCR template and character subset, and use a check digit. See [OCR Subset on page 330](#) and [OCR Template on page 331](#).

Scan one of the following barcodes to enable or disable OCR-A.



Enable OCR-A
(1)

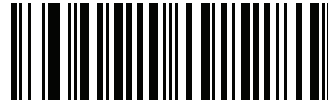

* Disable OCR-A
(0)

OCR-A Variant

Parameter # 684

SSI # F1 ACh



NOTE: Enable OCR-A before setting this parameter. If disabling OCR-A, set the variant to its default (OCR-A Full ASCII).

The font variant sets a processing algorithm and default character subset for the given font. To choose a variant, scan one of the following barcodes. Select the most appropriate font variant to optimize performance and accuracy.

OCR-A supports the following variants:

- OCR-A Full ASCII
!"#\$()*+,-./0123456789<>ABCDEFGHIJKLMNOPQRSTUVWXYZ^
- OCR-A Reserved 1
\$*+,-./0123456789ABCDEFGHIJKLMNOPQRSTUVWXYZ
- OCR-A Reserved 2
\$*+,-./0123456789<>ABCDEFGHIJKLMNOPQRSTUVWXYZ
- OCR-A Banking
-0123456789<> Ψ ϣ ϥ

Special banking characters output as the following representative characters:

Ψ outputs as f

ρ outputs as c

ϥ outputs as h



***OCR-A Full ASCII
(0)**



**OCR-A Reserved 1
(1)**

OCR-A Variant (continued)

**OCR-A Reserved 2
(2)**



**OCR-A Banking
(3)**

OCR-B**Parameter # 681****SSI # F1h A9h**

NOTE: OCR is not as secure as a barcode. To decrease OCR misdecodes and speed OCR reading, set an accurate OCR template and character subset, and use a check digit. See [OCR Subset on page 330](#) and [OCR Template on page 331](#).

Scan one of the following barcodes to enable or disable OCR-B.



**Enable OCR-B
(1)**

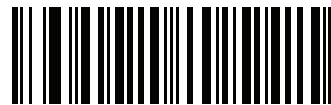

*** Disable OCR-B
(0)**

OCR-B Variant

Parameter # 685

SSI # F1h ADh



NOTE: Enable OCR-B before setting this parameter. If disabling OCR-B, set the variant to its default (OCR-B Full ASCII).

OCR-B has the following variants. Select the most appropriate font variant to optimize performance and accuracy.

- OCR-B Full ASCII
!#\$%()*+,-./0123456789<>ABCDEFGHIJKLMNOPQRSTUVWXYZ^|ñ
- OCR-B Banking
#+-0123456789<>JNP|
- OCR-B Limited
+,-./0123456789<>ACENPSTVX
- OCR-B ISBN 10-Digit Book Numbers
-0123456789>BCEINPSXz
- OCR-B ISBN 10 or 13-Digit Book Numbers
-0123456789>BCEINPSXz
- OCR-B Travel Document Version 1 (TD1) 3-Line ID Cards
-0123456789<ABCDEFGHIJKLMNOPQRSTUVWXYZ
- OCR-B Travel Document Version 2 (TD2) 2-Line ID Cards
-0123456789<ABCDEFGHIJKLMNOPQRSTUVWXYZ
- OCR-B Travel Document 2 or 3-Line ID Cards Auto-Detect
!#\$%()*+,-./0123456789<>ABCDEFGHIJKLMNOPQRSTUVWXYZ^|ñ
- OCR-B Passport
-0123456789<ABCDEFGHIJKLMNOPQRSTUVWXYZñ
- OCR-B Visa Type A
-0123456789<ABCDEFGHIJKLMNOPQRSTUVWXYZ
- OCR-B Visa Type B
-0123456789<ABCDEFGHIJKLMNOPQRSTUVWXYZñ
- OCR-B ICAO Travel Documents
This allows reading either TD1, TD2, Passport, Visa Type A, or Visa Type B without switching between these options. It automatically recognizes the travel document read.

Scanning any ISBN Book Number automatically applies the appropriate ISBN checksum.

To choose a variant, scan one of the barcodes below. Selecting the following OCR-B variants automatically sets the appropriate [OCR Lines on page 329](#). These five variants invoke extensive special algorithms and checking for that particular document type:

Variant	OCR Lines Setting
Passport	2
TD1 ID Cards	3
TD2 ID Cards	2
Visa Type A	2
Visa Type B	2



NOTE: When setting one of the variants above with both OCR-A and OCR-B enabled, the scanner reads the specified travel document but does not read OCR-A. When the OCR-B variant is set back to the default (OCR-B Full ASCII), the scanner reads OCR-A.



*** OCR-B Full ASCII
(0)**

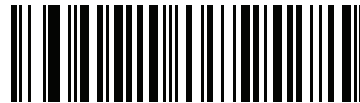

**OCR-B Banking
(1)**



**OCR-B Limited
(2)**



**OCR-B ISBN 10-Digit Book Numbers
(6)**

OCR-B Variant (continued)



**OCR-B ISBN 10 or 13-Digit Book Numbers
(7)**



**OCR-B Travel Document Version 1 (TD1)
3 Line ID Cards
(3)**



**OCR-B Travel Document Version 2 (TD2)
2-Line ID Cards
(8)**



**Travel Document 2 or 3-Line ID Cards Auto-Detect
(20)**



**OCR-B Passport
(4)**

OCR-B Variant (continued)



**OCR-B Visa Type A
(9)**



**OCR-B Visa Type B
(10)**



**OCR-B ICAO Travel Documents
(11)**

MICR E13B

Parameter # 682

SSI # F1h AAh



NOTE: OCR is not as secure as a barcode. To decrease OCR misdecodes and speed OCR reading, set an accurate OCR template and character subset, and use a check digit. See [OCR Subset on page 330](#) and [OCR Template on page 331](#).

Scan one of the following barcodes to enable or disable MICR E13B.

MICR E 13B uses the following characters:

0 1 2 3 4 5 6 7 8 9 t a o d

TOAD characters (Transit, On Us, Amount, and Dash) output as the following representative characters:

t outputs as t

a outputs as a

o outputs as o

d outputs as d



**Enable MICR E13B
(1)**

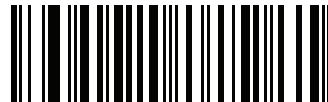

*** Disable MICR E13B
(0)**

US Currency Serial Number

Parameter # 683

SSI # F1h ABh

Scan one of the following barcodes to enable or disable US Currency Serial Number.



NOTE: OCR is not as secure as a barcode. To decrease OCR misdecodes and speed OCR reading, set an accurate OCR template and character subset, and use a check digit. See [OCR Subset on page 330](#) and [OCR Template on page 331](#).



**Enable US Currency
(1)**



*** Disable US Currency
(0)**

OCR Orientation

Parameter # 687

SSI # F1h AFh

Select one of five options to specify the orientation of the OCR to read:

- 0° to the imaging engine (default)
- 270° clockwise (or 90° counterclockwise) to the imaging engine
- 180° (upside down) to the imaging engine
- 90° clockwise to the imaging engine
- Omnidirectional

Setting an incorrect orientation can cause misdecodes.

OCR Orientation (continued)



* OCR Orientation 0°
(0)



OCR Orientation 270° Clockwise
(1)



OCR Orientation 180° Clockwise
(2)



OCR Orientation 90° Clockwise
(3)



OCR Orientation Omnidirectional
(4)

OCR Lines

Parameter # 691

SSI # F1h B3h

To select the number of OCR lines to decode, scan one of the following barcodes. Selecting Visas, TD1, or TD2 ID cards automatically sets the appropriate **OCR Lines**. Also see [OCR-B Variant on page 322](#).



* OCR 1 Line
(1)



OCR 2 Lines
(2)



OCR 3 Lines
(3)

OCR Minimum Characters

Parameter # 689

SSI # F1h B1h

To select the minimum number of OCR characters (not including spaces) per line to decode, scan the following barcode, then scan a three-digit number between 003 and 100 using the barcodes in [Numeric Barcodes](#) representing the number of OCR characters to decode. Strings of OCR characters less than the minimum are ignored. The default is 003.



OCR Minimum Characters

OCR Maximum Characters

Parameter # 690

SSI # F1h B2h

To select the maximum number of OCR characters (including spaces) per line to decode, scan the following barcode, then scan a three-digit number between 003 and 100 using the barcodes in [Numeric Barcodes](#) representing the number of OCR characters to decode. Strings of OCR characters greater than the maximum are ignored. The default is 100.



OCR Maximum Characters

OCR Subset

Parameter # 686

SSI # F1h AEh

Create an OCR subset to define a custom group of characters in place of a preset font variant. For example, if scanning only numbers and the letters A, B, and C, create a subset of just these characters to speed decoding. This applies a designated OCR Subset across all enabled OCR fonts.

To set or modify the OCR font subset:

1. Enable the appropriate OCR font(s).
2. Scan the **OCR Subset** barcode.
3. Scan numbers and letters to form the OCR Subset from [Alphanumeric Barcodes](#).
4. Scan [End of Message on page 331](#).

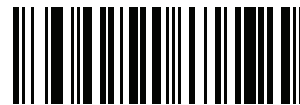

OCR Subset

To cancel an OCR subset, for OCR-A or OCR-B, scan OCR-A variant **Full ASCII**, or OCR-B variant **Full ASCII**.

For MICR E13B or US Currency Serial Number, create a subset which includes all allowed characters in that character set, or scan an option from the [Default Parameters on page 62](#) and re-program the scanner.

OCR Quiet Zone

Parameter # 695

SSI # F1h B7h

This option sets the OCR quiet zone. The scanner stops scanning a field when it detects a sufficiently wide blank space. The width of this space is defined by the End of Field option. Used with parsers that tolerate slanted characters, the End of Field count is approximately a count of 8 for a character width. For example, if set to 15, then two character widths are an end of line indicator for the parser. Larger end of field numbers require bigger quiet zones at each end of text line.

To set a quiet zone, scan the following barcode, then scan a two-digit number using the numeric keypad in [Numeric Barcodes](#). The range of the quiet zone is 20 - 99 and the default is 50, indicating a six character width quiet zone.



OCR Quiet Zone

OCR Template

Parameter # 547

SSI # F1h 23h

This option creates a template for precisely matching scanned OCR characters to a desired input format. Carefully constructing an OCR template eliminates scanning errors.

To set or modify the OCR decode template, scan the [OCR Template](#) barcode, and then scan barcodes on the following pages that correspond to numbers and letters to form the template expression. Then scan **End of Message**. The default is **99999999** which accepts OCR strings containing any character.



OCR Template



End of Message

Required Digit (9)

Only a numeric character is accepted in this position.

Template	Valid data	Valid data	Invalid data
99999	12987	30517	123AB



9

Required Alpha (A)

Only an alpha character is accepted in this position.

Template	Valid data	Valid data	Invalid data
AAAAA	ABCDE	UVWXY	12FGH



A

Require and Suppress (0)

Any character in this position, including space or reject, is suppressed from the output.

Template	Incoming data	Output
990AA	12QAB	12AB

Optional Alphanumeric (1)

An alphanumeric character is accepted in this position if present. Optional characters are not allowed as the first character(s) in a field of like characters.

Template	Valid data	Valid data	Invalid data
99991	1234A	12345	1234<



1

Optional Alpha (2)

An alpha character is accepted in this position if present. Optional characters are not allowed as the first character(s) in a field of like characters.

Template	Valid data	Valid data	Invalid data
AAAA2	ABCDE	WXYZ	ABCD6



2

Alpha or Digit (3)

An alphanumeric character is required in this position to validate the incoming data.

Template	Valid data	Valid data	Invalid data
33333	12ABC	WXYZ34	12AB<



3

Any Including Space & Reject (4)

Any character is accepted in this position, including space and reject. An underscore (_) represents rejects in the output. This is a good selection for troubleshooting.

Template	Valid data	Valid data
99499	12\$34	34 98



4

Any except Space & Reject (5)

Any character is accepted in this position, except a space or reject.

Template	Valid data	Valid data	Invalid data
55999	A.123	*Z456	A BCD



5

Optional Digit (7)

A numeric character is accepted if present. Optional characters are not allowed as the first character(s) in a field of like characters.

Template	Valid data	Valid data	Invalid data
99977	12345	789	789AB



7

Digit or Fill (8)

Any numeric or fill character is accepted in this position.

Template	Valid data	Valid data	Valid data
88899	12345	>>789	<<789



8

Alpha or Fill (F)

Any alpha or fill character is accepted in this position.

Template	Valid data	Valid data	Valid data
AAAF	ABCXY	LMN>>	ABC<5



F

Optional Space ()

A space is accepted if present. Optional characters are not allowed as the first character(s) in a field of like characters.

Template	Valid data	Valid data	Invalid data
99 99	12 34	1234	67891



Space

Optional Small Special (.)

A special character is accepted if present. Optional characters are not allowed as the first character(s) in a field of like characters. Small special characters are - , and .

Template	Valid data	Valid data	Invalid data
AA.99	MN.35	XY98	XYZ12



.

Other Template Operators

These template operators assist in capturing, delimiting, and formatting scanned OCR data.

Literal String (" and +)

Use either of these delimiting characters surrounding characters from the alphanumeric keyboard in [Alphanumeric Barcodes](#) to define a literal string within a template that must be present in scanned OCR data. There are two

characters used to delimit required literal strings; if one of the delimiter characters is present in the desired literal string, use the other delimiter.

Template	Valid data	Invalid data
"35+BC"	35+BC	AB+22



“



+

New Line (E)

To create a template of multiple lines, add **E** between the template of each single line.

Template	Valid data	Valid data	Invalid data
999EAAAA	321	987	XYZW
	BCAD	ZXYW	12



E

String Extract (C)

This operator combined with others defines a string of characters to extract from the scanned data. The string extract is structured as follows:

CbPe

Where:

- C is the string extract operator
- b is the string begin delimiter
- P is the category (one or more numeric or alpha characters) describing the string representation
- e is the string end delimiter

Values for *b* and *e* can be any scannable character. They are included in the output stream.

Template	Incoming data	Output
C>A>	XQ3>ABCDE>	>ABCDE>
	->ATHRUZ>123	>ATHRUZ>
	1ABCZXYZ	No Output



C

Ignore to End of Field (D)

This operator causes all characters after a template to be ignored. Use this as the last character in a template expression. Examples for the template 999D:

Template	Incoming data	Output
999D	123-PED	123
	357298	357
	193	193



D

Skip Until (P1)

This operator skips over characters until a specific character type or a literal string is detected. It can be used in two ways:

P1ct

Where:

- P1 is the Skip Until operator
- c is the type of character that triggers the start of output
- t is one or more template characters

P1"s"t

Where:

- P1 is the Skip Until operator
- "s" is one or more literal string characters (see [Literal String \(" and +\) on page 335](#)) that trigger the start of output
- t is one or more template characters

The trigger character or literal string is included in output from a Skip Until operator, and the first character in the template should accommodate this trigger.

Template	Incoming data	Output
P1"PN"AA9999	123PN9876	PN9876
	PN1234	PN1234
	X-PN3592	PN3592



P



1

Skip Until Not (P0)

This operator skips over characters until a specific character type or a literal string is not matched in the output stream. It can be used in two ways:

P0ct

Where:

- P0 is the Skip Until Not operator
- c is the type of character that triggers the start of output
- t is one or more template characters

P0"s"t

Where:

- P0 is the Skip Until Not operator
- "s" is one or more literal string characters (see [Literal String \(" and +\) on page 335](#)) that trigger the start of output
- t is one or more template characters

The trigger character or literal string is not included in output from a Skip Until Not operator.

Template	Incoming data	Output
P0A9999	BN3456	3456
	PN1234	1234
	5341	No output

Template	Incoming data	Output
P0"PN"9999	PN3456	3456
	5341	No output
	PNPN7654	7654



P



0

Repeat Previous (R)

This operator allows a template character to repeat one or more times, allowing the capture of variable-length scanned data. The following examples capture two required alpha characters followed by one or more required digits:

Template	Incoming data	Output
AA9R	AB3	AB3
	PN12345	PN12345
	32RM52700	No output



R

Scroll Until Match (S)

This operator steps through scanned data one character at a time until the data matches the template.

Template	Incoming data	Output
S99999	AB3	No Output
	PN12345	12345
	32RM52700	52700



S

Multiple Templates

This feature sets up multiple templates for OCR decoding. To do this, follow the procedure described in [OCR Template on page 331](#) (scan the [OCR Template](#) barcode, and then barcodes corresponding to numbers and letters to form the template expression, and then **End of Message**) for each template in the multiple template string, using a capital letter **X** as a separator between templates.

For example, set the [OCR Template](#) as **99999XAAAAA** to decode OCR strings of either **12345** or **ABCDE**.

Template Examples

Following are sample templates with descriptions of valid data for each definition.

Field Definition Description

"M"99977 M followed by three digits and two optional digits.

"X"997777"X" X followed by two digits, four optional digits, and an X.

9959775599 Two digits followed by any character, a digit, two optional digits, any two characters, and two digits.

A55"- "999"- "99 A letter followed by two characters, a dash, three digits, a dash, and two digits.

33A" . "99 Two alphanumeric characters followed by a letter, a period, and two digits.

999992991 Five digits followed by an optional alpha, two digits, and an optional alphanumeric.

"PN98" Literal field - **PN98**

OCR Check Digit Modulus

Parameter # 688

SSI # F1h B0h

The check digit is the last digit (in the right-most position) in an OCR string and improves the accuracy of the collected data. This option sets OCR module check digit calculation. The calculation is performed on incoming data to determine this check digit, based on the numeric weight of the alpha and numeric characters. See [OCR Check Digit Multiplier on page 341](#). If the incoming data does not match the check digit, the data is considered corrupt.

The selected check digit option does not take effect until you set [OCR Check Digit Validation on page 342](#).

To choose the Check Digit Modulus, such as 10 for Modulus 10, scan the following barcode, and then scan a three-digit number from 001 to 099 representing the check digit using the numeric keypad in [Numeric Barcodes](#). The default is 1.

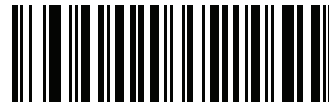

OCR Check Digit

OCR Check Digit Multiplier

Parameter # 700

SSI # F1h BCh

This option sets OCR check digit multipliers for character positions. For check digit validation, each character in scanned data has an assigned weight to use in calculating the check digit. The scanner OCR ships with the following weight equivalents:

0 = 0	A = 10	K = 20	U = 30
1 = 1	B = 11	L = 21	V = 31
2 = 2	C = 12	M = 22	W = 32
3 = 3	D = 13	N = 23	X = 33
4 = 4	E = 14	O = 24	Y = 34
5 = 5	F = 15	P = 25	Z = 35
6 = 6	G = 16	Q = 26	Space = 0
7 = 7	H = 17	R = 27	
8 = 8	I = 18	S = 28	
9 = 9	J = 19	T = 29	

All other characters are equivalent to one (1).

You can define the multiplier string if it is different from the default.

121212121212 (default)

123456789A (for ISBN, Product Add Right to Left. See [OCR Check Digit Validation on page 342](#))

For example:

ISBN	0	2	0	1	1	8	3	9	9	4
Multiplier	10	9	8	7	6	5	4	3	2	1
Product	0	18	0	7	6	40	12	27	18	4
Product add	0 +	18 +	0 +	7 +	6 +	40 +	12 +	27 +	18 +	4 = 132

ISBN uses Modulus 11 for the check digit. In this case, 132 is divisible by 11, so it passes the check digit.

To set the check digit multiplier, scan the following barcode, and then scan numbers and letters to form the multiplier string from [Alphanumeric Barcodes](#). Then scan [End of Message on page 331](#).

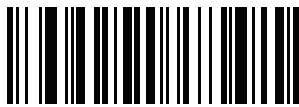

OCR Check Digit Multiplier

OCR Check Digit Validation

Parameter # 694

SSI # F1h B6h

Use the following options to protect against scanning errors by applying a check digit validation scheme.

None

No check digit validation, indicating no check digit is applied. This is the default.



*** No Check Digit
(0)**

Product Add Left to Right

Each character in the scanned data is assigned a numeric value (see [OCR Check Digit Multiplier on page 341](#)). Each digit representing a character in the scanned data is multiplied by its corresponding digit in the multiplier, and the sum of these products is computed. The check digit passes if this sum modulo Check Digit Modulus is zero.

Example:

Scanned data numeric value is 132456 (check digit is 6)

Check digit multiplier string is 123456

Digit	1	3	2	4	5	6	
Multiplier	1	2	3	4	5	6	
Product	1	6	6	16	25	36	
Product add	1+	6+	6+	16+	25+	36=	90

The Check Digit Modulus is 10. It passes because 90 is divisible by 10 (the remainder is zero).



Product Add Left to Right
(3)

Product Add Right to Left

Each character in the scanned data is assigned a numeric value (see [OCR Check Digit Multiplier on page 341](#)). The check digit multiplier is reversed in order. Each value representing a character in the scanned data is multiplied by its corresponding digit in the reversed multiplier, resulting in a product for each character in the scanned data. The sum of these products is computed. The check digit passes if this sum modulo Check Digit Modulus is zero.

Example:

Scanned data numeric value is 132459 (check digit is 9)

Check digit multiplier string is 123456

Digit	1	3	2	4	5	9	
Multiplier	6	5	4	3	2	1	
Product	6	15	8	12	10	9	
Product add	6+	15+	8+	12+	10+	9=	60

The Check Digit Modulus is 10. It passes because 60 is divisible by 10 (the remainder is 0).



**Product Add Right to Left
(1)**

Digit Add Left to Right

Each character in the scanned data is assigned a numeric value (see [OCR Check Digit Multiplier on page 341](#)). Each value representing a character in the scanned data is multiplied by its corresponding digit in the multiplier, resulting in a product for each character in the scanned data. The sum of each individual digit in all of the products is then calculated. The check digit passes if this sum modulo Check Digit Modulus is zero.

Example:

Scanned data numeric value is 132456 (check digit is 6)

Check digit multiplier string is 123456

Digit 1 3 2 4 5 6

Multiplier	1	2	3	4	5	6
------------	---	---	---	---	---	---

Product 1 6 6 16 25 36

Digit add $1+ 6+ 6+ 1+6+ 2+5+ 3+6= 36$

The Check Digit Modulus is 12. It passes because 36 is divisible by 12 (the remainder is 0).



**Digit Add Left to Right
(4)**

Digit Add Right to Left

Each character in the scanned data is assigned a numeric value (see [OCR Check Digit Multiplier on page 341](#)). The check digit multiplier is reversed in order. Each value representing a character in the scanned data is multiplied by its corresponding digit in the reversed multiplier, resulting in a product for each character in the scanned data. The sum of each individual digit in all of the products is then calculated. The check digit passes if this sum modulo Check Digit Modulus is zero.

Example:

Scanned data numeric value is 132456 (check digit is 6)

Check digit multiplier string is 123456

Digit	1	3	2	4	5	6	
Multiplier	6	5	4	3	2	1	
Product	6	15	8	12	10	6	
Digit add	6+	1+5+	8+	1+2+	1+0+	6=	30

The Check Digit Modulus is 10. It passes because 30 is divisible by 10 (the remainder is 0).



Digit Add Right to Left
(2)

Product Add Right to Left Simple Remainder

Each character in the scanned data is assigned a numeric value (see [OCR Check Digit Multiplier on page 341](#)). The check digit multiplier is reversed in order. Each value representing a character in the scanned data is multiplied by its corresponding digit in the reversed multiplier, resulting in a product for each character in the scanned data. The sum of these products **except for the check digit's product** is computed. The check digit passes if this sum modulo Check Digit Modulus is equal to the check digit's product.

Example:

Scanned data numeric value is 122456 (check digit is 6)

Check digit multiplier string is 123456

Digit	1	2	2	4	5	6	
Multiplier	6	5	4	3	2	1	
Product	6	10	8	12	10	6	
Product add	6+	10+	8+	12+	10=	46	6

The Check Digit Modulus is 10. It passes because 46 divided by 10 leaves a remainder of 6.



**Product Add Right to Left Simple Remainder
(5)**

Digit Add Right To Left Simple Remainder

Each character in the scanned data is assigned a numeric value (see [OCR Check Digit Multiplier on page 341](#)). The check digit multiplier is reversed in order. Each value representing a character in the scanned data is multiplied by its corresponding digit in the reversed multiplier, resulting in a product for each character in the scanned data. The sum of each individual digit in all of the products **except for the check digit's product** is then calculated. The check digit passes if this sum modulo Check Digit Modulus is equal to the check digit's product.

Example:

Scanned data numeric value is 122459 (check digit is 6)

Check digit multiplier string is 123456

Digit	1	2	2	4	5	9
Multiplier	6	5	4	3	2	1
Product	6	10	8	12	10	9
Digit add	6+	1+0+	8+	1+2+	1+0=	19 9

The Check Digit Modulus is 10. It passes because 19 divided by 10 leaves a remainder of 9.



**Digit Add Right to Left Simple Remainder
(6)**

Health Industry - HIBCC43

This is the health industry module 43 check digit standard. The check digit is the modulus 43 sum of all the character values in a given message, and is printed as the last character in a given message.

Example:

Supplier Labeling Data Structure: + A 1 2 3 B J C 5 D 6 E 7 1

Sum of values: $41+10+1+2+3+11+19+12+5+13+6+14+7+1 = 145$

Divide 145 by 43. The quotient is 3 with a remainder of 16. The check digit is the character corresponding to the value of the remainder (see Table 28), which in this example is 16, or **G**. The complete Supplier Labeling Data Structure, including the check digit, therefore is:

A 1 2 3 B J C 5 D 6 E 7 1 G

Table 28 Table of Numeric Value Assignments for Computing HIBC LIC Data Format Check Digit

0 = 0	9 = 9	I = 18	R = 27	- = 36
1 = 1	A = 10	J = 19	S = 28	. = 37
2 = 2	B = 11	K = 20	T = 29	Space = 38
3 = 3	C = 12	L = 21	U = 30	\$ = 39
4 = 4	D = 13	M = 22	V = 31	/ = 40
5 = 5	E = 14	N = 23	W = 32	+ = 41
6 = 6	F = 15	O = 24	X = 33	% = 42
7 = 7	G = 16	P = 25	Y = 34	
8 = 8	H = 17	Q = 26	Z = 35	



Health Industry - HIBCC43
(9)

Inverse OCR

Parameter # 856

SSI # F2h 58h

Inverse OCR is white or light words on a black or dark background. Select an option for decoding inverse OCR:

- **Regular Only** - Decode regular OCR (black on white) strings only.
- **Inverse Only** - Decode inverse OCR (white on black) strings only.
- **Autodiscriminate** - Decode both regular and inverse OCR strings.



* Regular Only
(0)



Inverse Only
(1)



Autodiscriminate
(2)

OCR Redundancy

Parameter # 1770

SSI # F8h 06h EAh

This option adjusts the number of times to decode an OCR text string before transmission. There are three levels of OCR decode redundancy. There is an inverse relationship between the redundancy level and OCR decoding aggressiveness. Increasing the level of the redundancy can reduce OCR scanning aggressiveness, so select only the level of redundancy necessary.

- **OCR Redundancy Level 1:** This default setting allows the scanner to operate in its most aggressive state while providing sufficient accuracy in decoding most in-spec OCR text strings.
- **OCR Redundancy Level 2:** This setting eliminates most misdecodes while maintaining reasonable aggressiveness.
- **OCR Redundancy Level 3:** Select this option with greater redundancy requirements if OCR Redundancy Level 2 fails to eliminate misdecodes.



* OCR Redundancy Level 1
(1)



OCR Redundancy Level 2
(2)



OCR Redundancy Level 3
(3)

Intelligent Document Capture (Hand-held Mode Only)

Introduction

Intelligent Document Capture (IDC) is Zebra advanced image processing firmware for select imager based scanners. This chapter describes the IDC functionality, provides parameter barcodes to control IDC features, and includes a quick start procedure.

The IDC Process

Intelligent Document Capture:

1. Verifies a barcode is appropriate to use as an IDC anchor or link. See [Barcode Acceptance Test on page 351](#).
2. Determines the rectangular region to capture as an image. See [Capture Region Determination on page 351](#).
3. Processes the captured image. See [Image Post Processing on page 352](#).
4. Transmits the data. See [Data Transmission on page 352](#).

Barcode Acceptance Test

Upon decoding a barcode, the scanner checks that the barcode fits the description of a barcode that anchors or links to an IDC form. To be accepted as an IDC barcode:

- The symbology must be enabled for decode, and also enabled via [IDC Symbology on page 356](#). The IDC firmware allows enabling between zero and eight symbologies simultaneously: Code 128, Code 39, Interleaved 2 of 5, Discrete 2 of 5, Codabar, PDF417, Data Matrix, and EAN-128.
- The decoded data must satisfy the values set in the [IDC Minimum Text Length](#) and [IDC Maximum Text Length](#) parameters. To disable either of these checks, set the value to zero.

If the barcode does not satisfy both requirements, it is sent as a normal (non-IDC) decode.

An IDC barcode is required when [IDC Operating Mode on page 355](#) is set to **Anchored** or **Linked**.

Free-Form operating mode does not require a barcode, but transmits decoded data if one is found and satisfies the requirements. If no barcode is decoded, the document capture process starts but may require specifying a non-zero value for the [IDC Delay Time on page 365](#). The scanner must wait for at least this amount of time after trigger pull before capturing a document, unless a barcode is decoded before the time expires.

If [Momentary Trigger Mode Timeout on page 77](#) is enabled, the barcode must be directly under the aiming pattern and within the scanner's decode range, and the region to capture must be completely within the scanner's field-of-view.

Capture Region Determination

After accepting an IDC barcode, the firmware establishes the region to capture as an image. The method used depends on the setting of the [IDC Operating Mode](#) as follows.

The IDC firmware emits a single low beep after successfully capturing a region. The scanner is then no longer capturing images and can be moved without disturbing the IDC output. Be sure to hold the trigger button until the decode beep, otherwise the IDC process may be aborted.

IDC Operating Mode = Anchored

A coordinate system is built based on the barcode in its rectified (de-skewed) form. The origin is the center of the barcode, and the x-axis is set toward the right, from the barcode's point of view. The unit module width of the barcode is the unit for x. Similarly, the y-axis is set toward the up direction. The unit for the y-axis is specified via the parameter [IDC Aspect on page 359](#). This is the aspect ratio of a thin bar or space - the barcode's height is divided by this value to get this unit. Set [IDC Aspect](#) to zero to automatically calculate the aspect ratio. The barcode can be of different sizes for the same form, as long as the center of the barcode is the same when the barcode's length changes.

From this coordinate system, the IDC area is determined using four parameters: offsets in x and y ([IDC X Coordinate](#), [IDC Y Coordinate](#)) to the region's top-left corner, and width and height ([IDC Width](#), [IDC Height](#)).

If the capture area is relatively large as compared to the barcode area, the calculation to obtain the capture area is prone to significant errors. A recommended solution is to enclose the form with a single black-lined rectangular border (a box), which is not in contact with any other line on the outside of the form (although it can be connected to lines on the inside of the form). When the [IDC Find Box Outline](#) is set, the firmware searches for the box, and does not decode if any edges are broken (such as by a protruding thumb).

The [IDC Zoom Limit](#) parameter controls the quality of the captured form. The IDC firmware rejects capturing a form unless the width is at least the [IDC Zoom Limit](#) percentage of the [IDC Width](#) parameter. For example, if [IDC Zoom Limit](#) is set to 100 and [IDC Width](#) is set to 150, the form must be at least 300 pixels wide before it is captured (each unit module is scaled to two pixels).

The [IDC Maximum Rotation](#) parameter controls the maximum rotation any edge of the form can have in relation to the scanner's horizontal or vertical axis.

IDC Operating Mode = Free-Form or Linked

The document capture region is a rectangular piece of paper, or a portion of it enclosed by a rectangular border. In either case, all four sides of the capture region must be completely within the scanner's field-of-view, and there must be sufficient contrast at the border of the capture region. For example, if a piece of white paper contains the document to capture, it must be put in front of a dark background.

By default, the scanner captures the largest rectangular region within the field-of-view. To specify a particular border type, use the [IDC Border Type](#) parameter.

The region must contain at least 10% of the field-of-view in two dimensions.

If an IDC barcode is decoded, IDC uses its location to start the search for the capture region. Otherwise, it searches the capture region from the center of the field-of-view. IDC also uses the orientation of a decoded IDC barcode to orient the output image.

Image Post Processing

After determining the document capture region, the firmware de-skews and re-samples the region as follows. Enabling [IDC Captured Image Brighten](#) calls normalization, which makes the brightness of the image uniform, and enhances contrast as a large percent of background pixels is made completely white (a smaller percent of pixels is made completely black if the firmware determines there is no danger of enhancing the contrast of a very bland area). Enabling [IDC Captured Image Sharpen](#) enhances the sharpness of the image.

IDC re-samples the image about one output pixel per input pixel for **Free-Form** or **Linked** modes and two pixels-per-module in **Anchored** mode.

IDC compresses and transmits the image in one of the standard image formats selected by the [IDC File Format Selector](#), [IDC Bits Per Pixel](#), and [IDC JPEG Quality](#) parameters.

Note that it may take several seconds for post processing to complete, depending on the size of the captured region, the options enabled, and the scanner model.

Data Transmission

After processing the captured image, IDC assembles the image with the decoded barcode data (if applicable) into an ISO/IEC 15434 style packet and transmits it to the host. The scanner issues the standard decode beep and the trigger can be released. Be sure to set the [USB Device Type on page 239](#) to **Symbol Native API (SNAPI) with Imaging Interface**.

PC Application and Programming Support

For a sample application running on the Microsoft Windows operating system, contact your Zebra representative. This application displays barcode data and/or captured images from Intelligent Document Capture enabled scanners and allows setting and reading IDC parameters. Complete source code and documentation are also provided for developing custom applications. The application includes documentation for the ISO/IEC 15434 format as used by the IDC firmware and C# code to process it.

Setting Parameters

This section describes the parameters controlling the IDC firmware and provides programming barcodes for setting them.

The scanner ships with the settings shown in [Table 29 on page 354](#) (also see [Parameter Defaults](#) for all defaults). If the default values suit requirements, programming is not necessary.

To set feature values, scan a single barcode or a short barcode sequence. The settings are stored in non-volatile memory and are preserved even when the imager powers down.



NOTE: Most computer monitors allow scanning barcodes directly on the screen. When scanning from the screen, be sure to set the document magnification to a level where you can see the barcode clearly, and bars and/or spaces do not merge.

To return all features to default values, scan the [Set Factory Defaults on page 62](#). Throughout the programming barcode menus, asterisks (*) indicate default values.

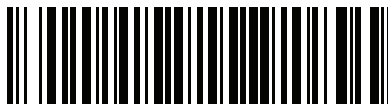

* Indicates default — ***Enable Parameter** — Feature/option
 (1) — Option value

Scanning Sequence Examples

In most cases scanning one barcode sets the parameter value. For example, to set the document capture file format to BMP, scan the **BMP** barcode under [IDC File Format Selector on page 359](#). The scanner issues a fast warble beep and the LED turns green, signifying a successful parameter entry.

Other parameters require scanning several barcodes. See the parameter descriptions for this procedure.

Errors While Scanning

Unless otherwise specified, to correct an error during a scanning sequence, just re-scan the correct parameter.

Image Document Capture Parameter Defaults

Table 29 lists defaults for IDC parameters. Change these values in one of two ways:

- Scan the appropriate barcodes in this chapter. The new value replaces the standard default value in memory. To recall default parameter values, see [Default Parameters on page 62](#).
- Configure the scanner using the 123Scan configuration program. See [123Scan and Software Tools](#).



NOTE: See [Parameter Defaults](#) for all user preference, host, symbology, and miscellaneous default parameters.

Alternatively, use the sample application to set parameters using the parameter name. The application provides prompts and error checking to assist in setting the parameters correctly and easily. You must use an application to set a parameter to a negative value, as the [IDC X Coordinate](#) can require.

Table 29 Intelligent Document Capture (IDC) Parameter Defaults

Parameter	Parameter Name	Parameter Number ¹	SSI Number ²	Default	Page Number
Intelligent Document Capture (IDC) Parameters					
IDC Operating Mode	DocCap_MODE	594	F1h 52h	Off	355
IDC Symbology	DocCap_SYMBODOLOGY	655	F1h 8Fh	001	356
IDC X Coordinate	DocCap_X	596	F4h F1h 54h	-151	357
IDC Y Coordinate	DocCap_Y	597	F4h F1h 55h	-050	357
IDC Width	DocCap_WIDTH	598	F1h 56h	0300	358
IDC Height	DocCap_HEIGHT	599	F1h 57h	0050	358
IDC Aspect	DocCap_ASPECT	595	F1h 53h	000	359
IDC File Format Selector	DocCap_FMT	601	F1h 59h	JPEG	359
IDC Bits Per Pixel	DocCap_BPP	602	F1h 5Ah	8 BPP	360
IDC JPEG Quality	DocCap_JPEG_Qual	603	F1h 5Bh	065	360
IDC Find Box Outline	Sig_FINDBOX	727	F1h D7h	Disable	361
IDC Minimum Text Length	DocCap_MIN_TEXT	656	F1h 90h	00	361
IDC Maximum Text Length	DocCap_MAX_TEXT	657	F1h 91h	00	362
IDC Captured Image Brighten	Sig_BRIGHTEN	654	F1h 8Eh	Enable	362
IDC Captured Image Sharpen	Sig_SHARPEN	658	F1h 92h	Enable	363
IDC Border Type	DocCap_BORDER	829	F2h 3Dh	None	364
IDC Delay Time	DocCap_DELAY	830	F2h 3Eh	000	365

1. Parameter number decimal values are used for programming via RSM commands.

2. SSI number hex values are used for programming via SSI commands.

Table 29 Intelligent Document Capture (IDC) Parameter Defaults (Continued)

Parameter	Parameter Name	Parameter Number ¹	SSI Number ²	Default	Page Number
IDC Zoom Limit	Sig_MIN_PERCENT	651	F1h 8Bh	000	365
IDC Maximum Rotation	Sig_MAX_ROT	652	F1h 8Ch	00	366

1. Parameter number decimal values are used for programming via RSM commands.
 2. SSI number hex values are used for programming via SSI commands.

IDC Operating Mode

Parameter Name: DocCap_MODE

Parameter # 594

SSI # F1h 52h

Select the operating mode of the Intelligent Document Capture firmware:

- **Off** - Disables the IDC feature.
- **Anchored** - Requires a barcode decode. The image capture region is based off this barcode.
- **Free-Form** - A printed border or page edge defines the image capture region. A barcode is optional.
- **Linked** - A printed border or page edge defines the image capture region. A barcode is required.

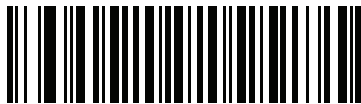

* Off
(0)



Anchored
(1)

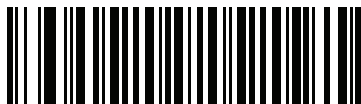

Free-Form
(2)



Linked
(3)

IDC Symbology

Parameter Name: DocCap_SYMBOLOGY

Parameter # 655

SSI # F1h 8Fh

Select the barcode type(s) to use when Document Capture mode is not set to **Off**. To enable more than one symbology at a time, simply add the values together. For example, to enable PDF417, Data Matrix, and Code 39 write a value of 98 (32 + 64 + 2).

Scan the following barcode, and then scan three barcodes from [Numeric Barcodes](#) in the range of 001 to 511 decimal. The default is 001.

Table 30 IDC Symbologies

Symbology	Value (Decimal)
Code 128	1
Code 39	2
I 2 of 5	4
D 2 of 5	8
Codabar	16
PD 417	32
Data Matrix	64
EAN 128	128
Aztec	256



IDC Symbology

IDC X Coordinate

Parameter Name: DocCap_X

Parameter # 596

SSI # F4h F1h 54h

This parameter only applies when [IDC Operating Mode](#) is set to **Anchored**. Specify the horizontal offset to the top left corner of the region to capture relative to the center of the barcode. Negative values move toward the left.

Scan the following barcode, and then scan four barcodes from [Numeric Barcodes](#) in the range of +/- 1279. The default is -151. Note that you must use an application to set a negative value.



IDC X Coordinate

IDC Y Coordinate

Parameter Name: DocCap_Y

Parameter # 597

SSI # F4h F1h 55h

This parameter only applies when [IDC Operating Mode](#) is set to **Anchored**. Specify the vertical offset to the top left corner of the region to capture relative to the center of the barcode. Negative values move toward the top.

Scan the following barcode, and then scan four barcodes from [Numeric Barcodes](#) in the range of +/- 1023. The default is -050. Note that you must use an application to set a negative value.



IDC Y Coordinate

IDC Width

Parameter Name: DocCap_WIDTH

Parameter # 598

SSI # F1h 56h

This parameter only applies when [IDC Operating Mode](#) is set to **Anchored**. Specify the width of the region to capture.

Scan the following barcode, and then scan four barcodes from [Numeric Barcodes](#) in the range of 0000 to 1279. The default is 0300.



IDC Width

IDC Height

Parameter Name: DocCap_HEIGHT

Parameter # 599

SSI # F1h 57h

This parameter only applies when [IDC Operating Mode](#) is set to **Anchored**. Specify the height of the region to capture.

Scan the following barcode, and then scan four barcodes from [Numeric Barcodes](#) in the range of 0000 to 1279. The default is 0050.

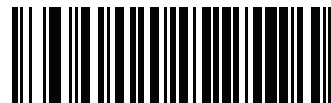

IDC Height

IDC Aspect

Parameter Name: DocCap_ASPECT

Parameter # 595

SSI # F1h 53h

This parameter only applies when [IDC Operating Mode](#) is set to **Anchored**. Specify the barcode's aspect ratio of a thin bar or space. The barcode's height is divided by this value to obtain the unit in the y-axis. Set this parameter to zero to calculate the aspect value automatically.

Scan the following barcode, and then scan three barcodes from [Numeric Barcodes](#) in the range of 000 to 255. The default is 000.

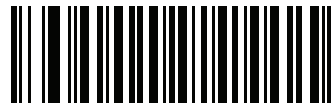

IDC Aspect

IDC File Format Selector

Parameter Name: DocCap_FMT

Parameter # 601

SSI # F1h 59h

Select a document capture file format appropriate for your system (BMP, TIFF, or JPEG). The scanner stores captured areas in the selected format.



*** JPEG
(1)**

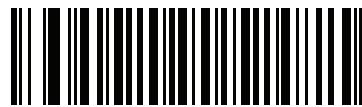

**BMP
(3)**



**TIFF
(4)**

IDC Bits Per Pixel

Parameter Name: DocCap_BPP

Parameter # 602

SSI # F1h 5Ah

Select the number of significant bits per pixel (BPP) to use when capturing an image. Select 1 BPP for a black and white image, 4 BPP to assign 1 of 16 levels of grey to each pixel, or 8 BPP to assign 1 of 256 levels of grey to each pixel.



NOTE: The scanner ignores these settings for JPEG file formats, which only support 8 BPP.



**1 BPP
(0)**



**4 BPP
(1)**



*** 8 BPP
(2)**

IDC JPEG Quality

Parameter Name: DocCap_JPEG_Qual

Parameter # 603

SSI # F1h 5Bh

Set the amount of JPEG compression to perform on the captured image. Higher numbers produce a better quality image but larger files.

Scan the following barcode, and then scan three barcodes from [Numeric Barcodes](#) in the range of 005 to 100 decimal. The default is 065.



IDC JPEG Quality

IDC Find Box Outline

Parameter Name: Sig_FINDBOX

Parameter # 727

SSI # F1h D7h

This parameter only applies when [IDC Operating Mode](#) is set to **Anchored**. Scan **Enable Find Box Outline** to search for a rectangular border during document capture.

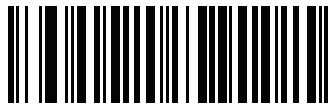

Enable Find Box Outline
(1)

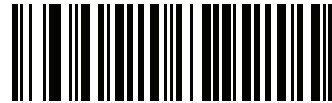

* Disable Find Box Outline
(0)

IDC Minimum Text Length

Parameter Name: DocCap_MIN_TEXT

Parameter # 656

SSI # F1h 90h

Specify the minimum number of characters encoded in a barcode for the IDC firmware to use it as an anchored or linked barcode. Set this to zero (the default) to disable all checking and use all barcodes.

Scan the following barcode, and then scan two barcodes from [Numeric Barcodes](#) in the range of 00 to 55 decimal. The default is 00.



IDC Minimum Text Length

IDC Maximum Text Length

Parameter Name: DocCap_MAX_TEXT

Parameter # 657

SSI # F1h 91h

Specify the maximum number of characters encoded in a barcode for the IDC firmware to use it as an anchored or linked barcode. Set this to zero (the default) to disable all checking and use all barcodes.

Scan the following barcode, and then scan two barcodes from [Numeric Barcodes](#) in the range of 00 to 55 decimal. The default is 00.



IDC Maximum Text Length

IDC Captured Image Brighten

Parameter Name: Sig_BRIGHTEN

Parameter # 654

SSI # F1h 8Eh

Enable **Captured Image Brighten** to make image brightness uniform and enhance contrast such that a large percent of the background pixels is made completely white (a smaller percent of pixels is made completely black if the program determines there is no danger of enhancing the contrast of a very bland area).



NOTE: This parameter is also used for Signature Capture.

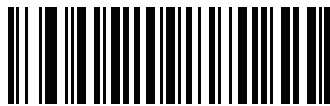

* Enable Captured Image Brighten
(1)



Disable Captured Image Brighten
(0)

IDC Captured Image Sharpen

Parameter Name: Sig_SHARPEN

Parameter # 658

SSI # F1h 92h

Enable this to enhance the sharpness of the image.



NOTE: This parameter is also used for Signature Capture.



*** Enable Captured Image Sharpen
(1)**



**Disable Captured Image Sharpen
(0)**

IDC Border Type

Parameter Name: DocCap_BORDER

Parameter # 829

SSI # F2h 3Dh

This parameter only applies when [IDC Operating Mode](#) is set to **Free-Form** or **Linked**. Select the style of border used to determine the outline of the capture region:

- **None** - Capture the largest rectangular region within the field-of-view.
- **Black** - The border must be black (such as a printed rectangular border).
- **White** - The border must be white (e.g., paper edge on a dark background).
- **Advanced Edge Detection (AED)** - Capture a region defined by edges of any color and potentially broken.



* None
(0)



Black
(1)



White
(2)



Advanced Edge Detection (AED)
(3)

IDC Delay Time

Parameter Name: DocCap_DELAY

Parameter # 830

SSI # F2h 3Eh

This parameter only applies when [IDC Operating Mode](#) is set to **Free-Form**. Set the delay for capturing a document after a trigger pull. Decoding a barcode aborts this delay.

Scan the following barcode, and then scan three barcodes from [Numeric Barcodes](#) in the range of 000 to 200 decimal in units of 10 msec. The default is 000.



IDC Delay Time

IDC Zoom Limit

Parameter Name: Sig_MIN_PERCENT

Parameter # 651

SSI # F1h 8Bh

This parameter only applies when [IDC Operating Mode](#) is set to **Anchored**. Set the minimal "zoom" percentage value of a form for it to be considered for capture. This controls the quality of the captured form. The IDC firmware rejects capturing a form unless the width is at least the [IDC Zoom Limit](#) percentage of the [IDC Width](#) parameter. For example, if you set this parameter to 100 and [IDC Width](#) to 150, the form must be at least 300 pixels wide before it is captured (each unit module is scaled to two pixels).

Set this to zero (the default) to disable all checking.

Scan the following barcode, and then scan three barcodes from [Numeric Barcodes](#) in the range of 000 to 100 percent. The default is 000.



IDC Zoom Limit

IDC Maximum Rotation

Parameter Name: Sig_MAX_ROT

Parameter # 652

SSI # F1h 8Ch

This parameter only applies when [IDC Operating Mode](#) is set to **Anchored**. Set the maximum rotation any edge of the form can have in relation to the scanner's horizontal or vertical axis for it to be considered for capture. Set this to zero (the default) to disable all checking.

Scan the following barcode, and then scan two barcodes from [Numeric Barcodes](#) in the range of 00 to 45 decimal. The default is 00.

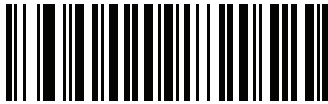

IDC Maximum Rotation

Quick Start

This section familiarizes you with some of the Intelligent Document Capture features. [IDC Demonstrations on page 368](#) includes instructions to demonstrate the Anchored, Free-Form, and Linked modes using a sample form to provide an understanding of how to use IDC. These examples do not illustrate all capabilities of the advanced IDC firmware. Build upon these using different parameter settings and forms.

Sample IDC Setup

To set up IDC:

1. Connect a scanner equipped with IDC to the host computer's USB port.
2. To set the scanner to the default settings and proper USB host type, scan **Set Defaults** followed by the **Symbol Native API (SNAPI) with Imaging Interface** barcode. Allow time for the scanner to reset and the USB connection to remunerate after each scan before continuing.



Set Defaults



Symbol Native API (SNAPI) with Imaging Interface

3. Start the sample application and select the scanner in the **SNAPI Scanners** drop-down menu.
4. Set parameters as specified in [IDC Demonstrations on page 368](#) using the sample application or by scanning parameter barcodes in this guide. The barcode in the sample form is Code 128, which is enabled by default for decoding and as a Document Capture symbology. You can change these settings for your IDC application.
5. Perform each demo. When scanning, aim the scanner at the barcode in the center of the rectangle. Pull the scanner back so the rectangle is fully contained in the aiming pattern. When you pull the trigger, the scanner emits a low tone to indicate that the IDC firmware identified and captured an image, then a decode beep to indicate that the data transmitted. There may be several seconds between the two beeps, depending on the size of the captured image and options selected (de-skew, brighten, etc). You can move the scanner after the first beep, but continue to hold the trigger or the scanner may end the session before sending the data.

IDC Demonstrations

Anchored Mode Demo

- Set [IDC Operating Mode on page 355](#) to **Anchored**.
- Set parameters to these values:
 - Set [IDC Height on page 358](#) to **100**.
 - Set [IDC Width on page 358](#) to **90**.
 - Set [IDC X Coordinate on page 357](#) to **-175**.
 - Set [IDC Y Coordinate on page 357](#) to **-50**.
- Pull the trigger. The scanner decodes the barcode and captures an image of the text scroll.
- Rotate the form clockwise so the word **Capture** is along the bottom edge, and pull the trigger. The scanner decodes the barcode and captures the same image, including orientation. (This example also works with the form rotated counter-clockwise or upside down).
- Modify the values for height, width, x, and y. Pull the trigger. The captured area changes in size and location.
- Cover the barcode with a small piece of paper (or your finger) and pull the trigger. The scanner does not decode the barcode or capture an image.

What This Demonstrates

Anchored mode captures an image of fixed size and location relative to a barcode on the page. Parameters control the height, width, and location. The IDC firmware requires that a barcode is present in order to capture an image. It decodes the barcode and uses it to adjust the image to the upright orientation.

Free-Form Mode Demo

- Set [IDC Operating Mode on page 355](#) to **Free-Form**.
- Pull the trigger. The scanner decodes the barcode and captures an image of the entire rectangle, including the contents.
- Modify the values for height, width, x, and y. Pull the trigger. Note that the captured image is not affected.
- Rotate the form clockwise so the word **Capture** is along the bottom edge, and pull the trigger. The scanner decodes the barcode and captures the same image, including orientation. (This example also works with the form rotated counterclockwise or upside down).
- Cover the barcode with a small piece of paper and pull the trigger. The scanner does not decode the barcode and does not re-orient the captured image to the normal position, i.e., with the logo in the upper-left corner.

What This Demonstrates

Free-Form mode captures an image where a rectangular border on the page determines the size and position. It adjusts the image to the upright orientation if a barcode is found and decoded in the image.

Linked Mode Demo

Set [IDC Operating Mode on page 355](#) to **Linked**.

Use the examples from the [Free-Form Mode Demo](#), noting that the last item (covering the barcode) does not decode the barcode or capture an image.

What This Demonstrates

Linked mode captures an image where a rectangular border on the page determines the size and position. The IDC firmware requires that a barcode is present in order to capture an image. It decodes the barcode and uses it to adjust the image to the upright orientation.

Other Suggestions

Hold the scanner at an angle (up/down or side to side) to the page instead of perpendicular to it. The IDC firmware de-skews and adjusts the brightness (enabled by default) to produce a quality image when the scanner is held at less than ideal conditions.

Quick Start Form

Figure 24 Quick Start Form

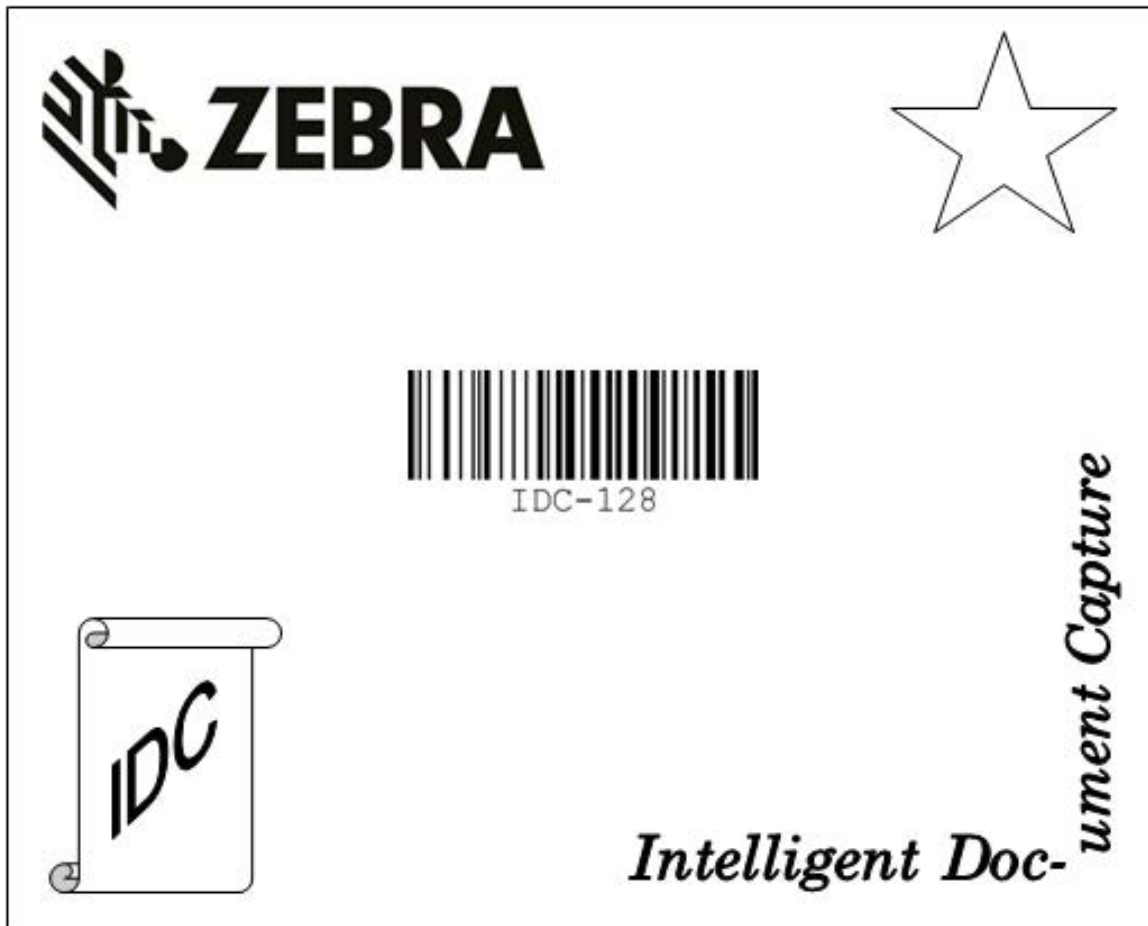

Digimarc

Introduction

Digimarc Barcode is a machine-readable code that is invisible to people.

Digimarc Symbology Selection

Digimarc codes are reported as UPC-A, UPC-E, EAN-13 or GS1 DataBar Expanded.



NOTE: Conversion of the Digimarc reported code types to other barcode types is not supported.

AIM and Symbol code IDs are supported for the reported Digimarc code types.

Picklist

The Digimarc decoder searches configured block areas of the image for Digimarc codes. The Digimarc decoder works the same whether or not Picklist is enabled or disabled.



NOTE: Decode time could be greater given the extra processing done by system and decoder when in Picklist mode.

Digimarc Digital Watermarks

Parameter # 1687

SSI # F8h 06h 97h

To enable or disable the Digimarc Digital Watermarks code scan the appropriate barcode below.



NOTE: Enabling Digimarc Digital Watermarks/DW increases decode times slightly. Increasing the [Timeout Between Decodes, Same Symbol on page 80](#) may be required to avoid double decodes.

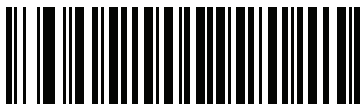

*** Enable Digimarc Digital Watermarks/DW
(1)**



**Disable Digimarc Digital Watermarks/DW
(0)**

Data Formatting: ADF, MDF, Preferred Symbol

Introduction

This chapter briefly describes the Zebra features available for customizing scanner operation.

Advanced Data Formatting (ADF)

Advanced Data Formatting (ADF) allows customizing data before transmission to the host device. Use ADF to edit scanned data to suit the host application's requirements. With ADF you scan one barcode per trigger pull. ADF is programmed using 123Scan.

For a video on Creating an Advanced Data Formatting (ADF) Rule using 123Scan, go to: www.zebra.com/ScannerHowToVideos.

For additional information, refer to the Advanced Data Formatting Programmer Guide.

Multicode Data Formatting (Hand-held Mode Only)

Multicode Data Formatting (MDF) enables a 2D scanner to scan all barcodes on a label with a single trigger pull, and then modify and transmit the data to meet host application requirements. MDF supports programming up to nine unique labels into one scanner. MDF also supports scanning multiple barcodes on opposite sides of a box by holding the trigger.

Programming options include:

- Output all or specific barcodes
- Control the barcode output sequence
- Apply unique multicode data formatting (MDF) to each output barcode
- Discard scanned data if all required barcodes are not present

For more information, refer to the *MDF and Preferred Symbol User Guide*.

To watch a video on Creating an Multicode Data Formatting (MDF) Rule using 123Scan, go to: <http://www.zebra.com/ScannerHowToVideos>

MDF in Hands-Free Mode

MDF in a hands-free scanning mode may yield multiple unexpected and undesired outputs when a label (most likely on a complex label) passes through the scanner's field of view. This problem happens when the complex label's barcodes can be matched by more than one group (for example, Group 1 represents all barcodes present and Group 2 represent some barcodes present).



NOTE: A similar problem can also occur in the hand-held trigger mode. If multiple MDF rules/groups exist and all the label is not in the field of view when pressing the trigger, the output may vary depending on which MDF rules/groups match.

The problem is demonstrated in [Figure 25](#) and as follows:

1. As the label is moving through the field of view, it is first partially read (some of the barcodes in the field of view in Frame 2).
2. Then, the second decode occurs as it is fully read (all the barcodes in the field of view in Frame 3).
3. This yields two different outputs (instead of the expected single output) from the presentation of a label. This problem is driven by a complex label inadvertently matching two different MDF rules/groups, thereby yielding two outputs.

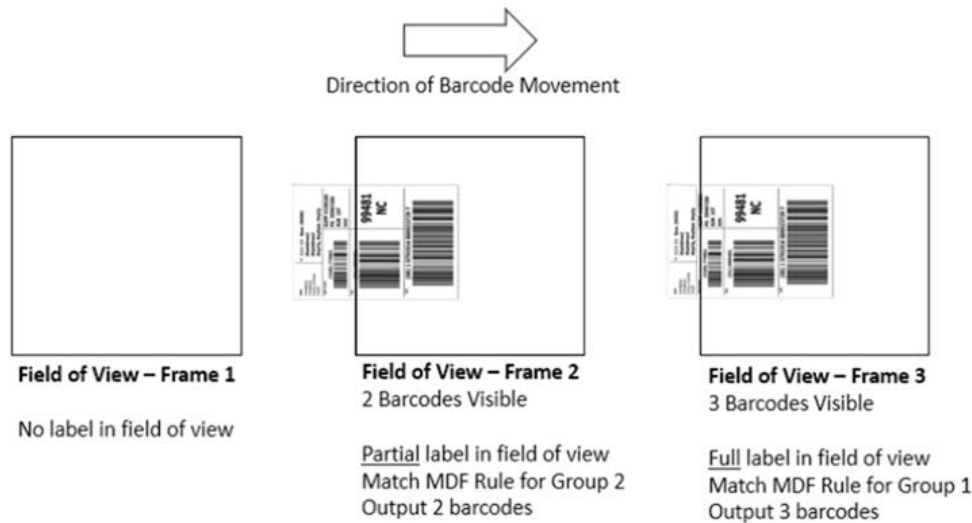

Figure 25 Scanning Label in a Horizontal Orientation



NOTE: To minimize issues associated with MDF hands-free mode, see [MDF Best Practices on page 374](#).

MDF Best Practices

Suggestions to minimize the undesired multiple outputs during the MDF scanning in hands-free mode are as follows:

- Scan barcodes in a vertical orientation (see [Figure 26](#)).

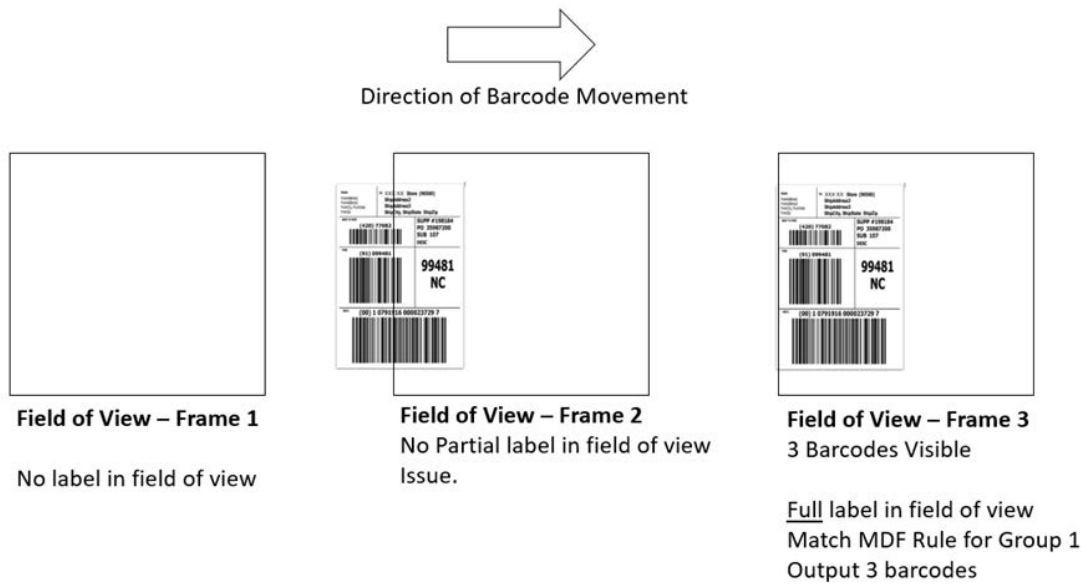

Figure 26 Scanning Label in a Vertical Orientation

- When creating the MDF programming with multiple groups, the Group 1's pattern match should be the most complicated (hardest to match), which equals to the most number of barcodes and criteria. Then Group 2, 3, and so on should be progressively matched more easily.
- When defining criteria, avoid enabling an output when the pattern is not matched. Set **Output if NO pattern match set** as **Discard bar code** (see [Figure 27](#)).

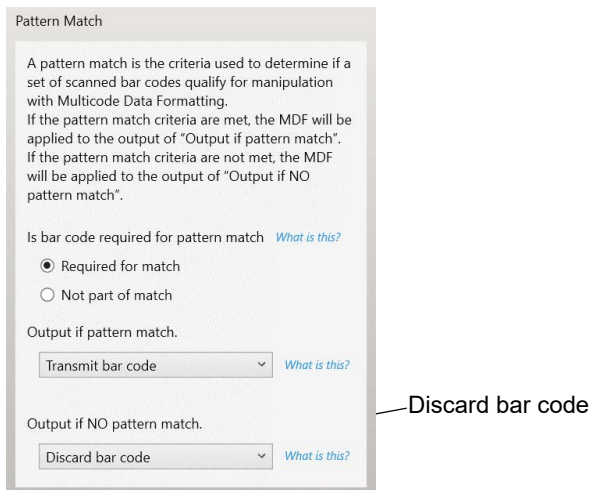

Figure 27 Figure Match Setting for Output

- Select **Discard barcode(s) NOT within the pattern match** in the 123Scan MDF setting. For more details, select **What is this?** located next to this selection.
- Discard scanned bar code(s) NOT within pattern match [What is this?](#)

- To prevent double decodes of the same symbol, increase the **Timeout Between Same Symbols** setting. See [Timeout Between Decodes, Same Symbol on page 80](#) for more details.
- Turn the scanner's aimer on to assist operators in scanning the barcode in a more consistent manner.

Other reasons a label/barcode may not be decoded while in the field of view are as follows:

- The label out of focus (too close or too far away). See [Decode Ranges on page 47](#) for correct working range.
- Specular reflection (reflection off a shiny surface).
- The label is presented at extreme angle to scanner.

Preferred Symbol

Preferred Symbol is a barcode prioritization technique that enables favored decoding of high priority barcode(s). The Preferred Symbol is the only barcode that is decoded and output within the preset Preferred Symbol Timeout. During this time, the scanner attempts to decode the prioritized barcode and reports only this barcode.

For more information, refer to the Multicode Data Formatting and Preferred Symbol User Guide, p/n MN-002895-xx.

To program Preferred Symbol via 123Scan, select 123Scan > Configuration Wizard > Symbologies screen, and then select Preferred Symbol from the drop-down menu. Preferred Symbol programming is saved in the 123Scan configuration file.

Data Parsing (UDI Scan+, Label Parse+ and Blood Bag Parse+)

Data Parsing allows a Zebra scanner to scan a UDI label, GS1 label, or Blood Bags with one or more barcodes encoded with multiple data fields (such as date of manufacture, expiration date, batch number, GTIN, and SSCC) and transmit select data fields and not others, in a specific order to a host application. Simply wave the scanner over all the barcodes while holding the trigger and the scanner takes care of the rest.

The scanner finds and transmits only the required data fields, even if they are spread across multiple barcodes and on different sides of the container. In addition, the scanner can insert field separators (such as tab, enter, and slash) to automate data entry into a host application.

Programming your scanner is easy using 123Scan's intuitive drag and drop interface. For more information on writing a Data Parsing Rule, refer to the Data Parsing (UDI, GS1 Label, Blood Bag) on Zebra Scanners User Guide available at: zebra.com/support.

To watch a video on Creating a Data Parsing Rule using 123Scan, go to: zebra.com/ScannerHowToVideos.

Scan a UDI Label using UDI Scan+

Government regulatory agencies¹ establish Unique Device Identification (UDI) standards to identify and monitor the distribution and use of medical devices within healthcare environments. These UDI standards identify medical devices from manufacturing through distribution to patient use - enabling complete traceability of the millions of individual medical devices utilized for patient care. To enable UDI compliance, all medical devices must carry a UDI label to enable "track and trace" from the point of production, during shipment, through the product's use and disposal.



NOTE: ¹ United States Food and Drug Administration (FDA), European Commission, International Medical Device Regulatory Forum.

Scan a GS1 Label using Label Parse+

The GS1 Organization, an international standards body, has released specifications used worldwide for generating shipping labels. These labels are used when shipping packages (logistics), raw materials and produce.

Scan a Blood Bag Label using Blood Bag Parse+

The ICCBBA Organization, an international standards body, has released a specification used worldwide for generating blood bag labels. These labels are used when shipping, storing and using blood bags. For more information, go to: icbba.org/tech-library/icbba-documents/standards-documents/standard-labeling-blood2.

Driver's License Set Up (DS9308-DL)

Introduction

The scanner uses internally embedded algorithms to parse out barcode information from standard US driver's licenses and certain other American Association of Motor Vehicle Administrators (AAMVA) compliant ID cards. Scanning these barcodes produces formatted data for use in age verification, credit card application information, and more.

This chapter describes how to program the scanner to read and use the data contained in the 2D barcodes on US driver's licenses and AAMVA compliant ID cards.

Table 31 DL Parsing Parameter Table

Parameter	Default	Page Number
DL Parsing Parameters		
Driver's License Parsing	No Driver's License Parsing	378
Parsing Driver's License Data Fields	N/A	379
Driver's License Parse Field Barcodes	N/A	380
AAMVA Parse Field Barcodes	N/A	382
Parser Version ID Barcode	N/A	391
Set Default Parameter	N/A	392
Output Gender as M or F	N/A	392
Date Format	CCYYMMDD	393
No Separator	N/A	394
Send Keystroke	N/A	395
Control Characters		395
Keyboard Characters		399
Parsing Rule Example	N/A	413
Embedded Driver's License Parsing ADF Example	N/A	417

Driver's License Parsing

Parameter # 645

SSI # F1 85

To enable driver's license parsing on the scanner, scan the **Embedded Driver's License Parsing** barcode. This does not require Zebra software (.DLL).

Scan the barcodes on the following pages in the order indicating the sequence of data fields that the scanner outputs. See [Parsing Driver's License Data Fields \(Embedded Driver's License Parsing\) on page 379](#) for more information.



* No Driver's License Parsing



Embedded Driver's License Parsing

Parsing Driver's License Data Fields (Embedded Driver's License Parsing)

To program a parsing rule:

1. Scan [Begin New Driver's License Parse Rule on page 380](#).
2. Scan any of the field barcodes on the following pages, or [Send Keystroke \(Control Characters and Keyboard Characters\) on page 395](#).
3. After entering the entire rule, scan [Save Driver's License Parse Rule on page 380](#) to save the rule.



NOTE: The scanner stores only one driver's license parsing rule in memory at a time. Saving a new rule replaces the prior rule.

To abort the programming sequence at any time during programming, scan [Quit Entering Driver's License Rule on page 380](#). Any previously saved rule is retained.

To erase a saved rule, scan [Erase Driver's License Parse Rules on page 380](#).

Embedded Driver's License Parsing Criteria - Code Type

After specifying the fields and their order for the parsed driver's license, you can also apply standard ADF rules to the parsed data using the **Parsed Driver's License** criterion barcode in the *Advanced Data Formatting Programmer Guide*.



NOTE: Only create standard ADF rules on parsed driver's license data when configured for Embedded Driver's License Parsing.

See [Embedded Driver's License Parsing ADF Example on page 417](#) for a sample ADF rule using this code type criterion.

Driver's License Parse Field Barcodes



Begin New Driver's License Parse Rule



Save Driver's License Parse Rule



Quit Entering Driver's License Rule



Erase Driver's License Parse Rules

The supported parse fields begin below. Not all IDs present data in the same format. For example, some IDs can have separate fields for first name, last name, and middle initial, while others have a single field with the entire name. Also, some IDs expire on the subject's birth date while the expiration date field only indicates the year. To present data in a consistent format, use the following nine barcodes to return data calculated from the actual data contained in the ID barcode.



First Name



Middle Name/Initial

Driver's License Parse Field Barcodes (continued)



Last Name



Name Suffix

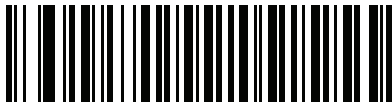

Name Prefix



Expiration Date

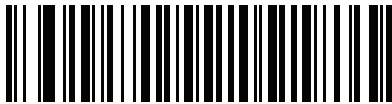

Birth Date



Issue Date



ID Number (Formatted)

AAMVA Parse Field Barcodes



AAMVA Issuer ID



Full Name

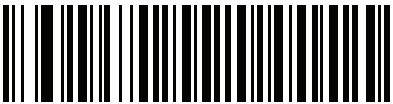

Last Name

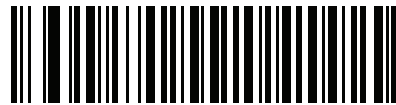

First Name



Middle Name / Initial



Name Suffix



Name Prefix

AAMVA Parse Field Barcodes (continued)



Mailing Address Line 1



Mailing Address Line 2



Mailing Address City

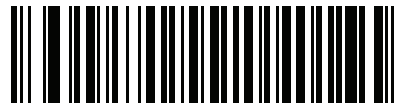

Mailing Address State



Mailing Address Postal Code



Home Address Line 1



Home Address Line 2

AAMVA Parse Field Barcodes (continued)



Home Address City



Home Address State

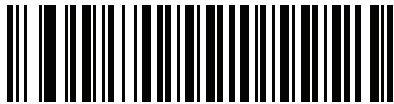

Home Address Postal Code

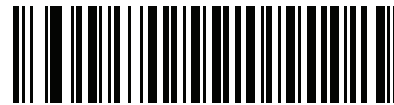

License ID Number



License Class



License Restrictions



License Endorsements

AAMVA Parse Field Barcodes (continued)



Height (Feet and/or Inches)



Height (Centimeters)

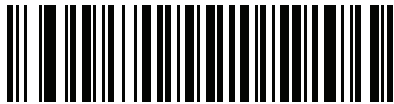

Weight (Pounds)

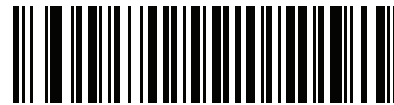

Weight (Kilograms)



Eye Color

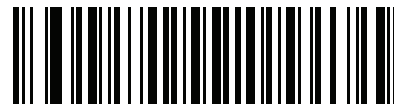

Hair Color



License Expiration Date

AAMVA Parse Field Barcodes (continued)



Birth Date



Gender



License Issue Date

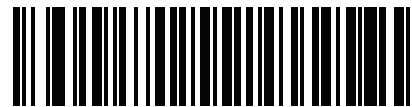

License Issue State



Social Security Number

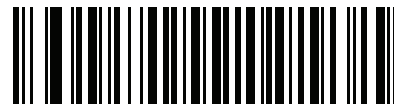

Permit Class



Permit Expiration Date

AAMVA Parse Field Barcodes (continued)

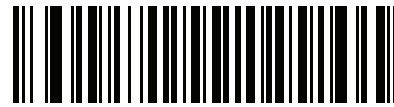

Permit ID Number

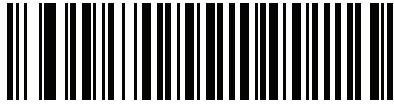

Permit Issue Date

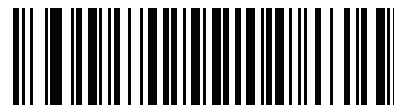

Permit Restrictions



Permit Endorsements

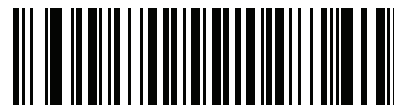

AKA Social Security Name



AKA Full Name



AKA Last Name



AKA First Name

AAMVA Parse Field Barcodes (continued)

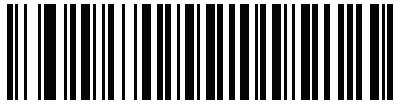

AKA Middle Name / Initial

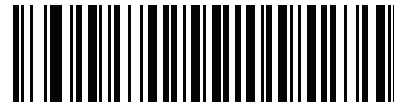

AKA Name Suffix

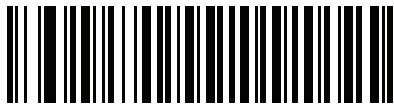

AKA Name Prefix



AKA Birth Date

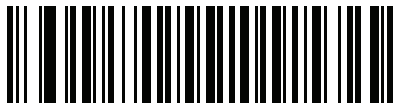

Issue Timestamp

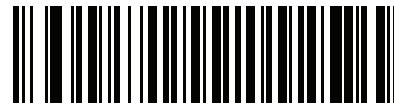

Number of Duplicates



Medical Codes

AAMVA Parse Field Barcodes (continued)

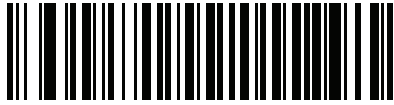

Organ Donor



Nonresident

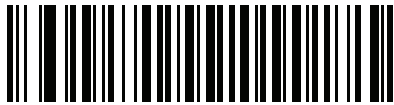

Customer ID

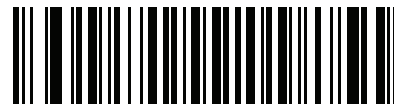

Weight Range



Document Discriminator



Country



Federal Commission Codes

AAMVA Parse Field Barcodes (continued)



Place of Birth

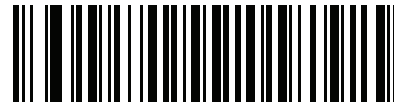

Audit Information

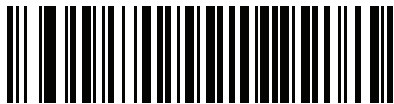

Inventory Control



Race / Ethnicity



Std Vehicle Class



Std Endorsements



Std Restrictions

AAMVA Parse Field Barcodes (continued)



Class Description



Endorsement Description

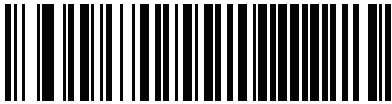

Restrictions Description

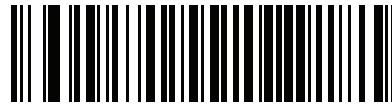

Height in Inches

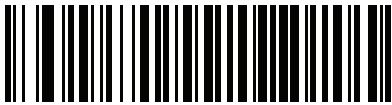

Height in Centimeters

Parser Version ID Barcode

Include this field to emit embedded parser software version identification

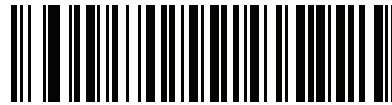

Parser Version ID

User Preferences

Set Default Parameter

Scan this barcode to return all parameters to the default values listed in [Table 32 on page 426](#).



* Set All Defaults

Output Gender as M or F

Scan this barcode to report the gender as **M** or **F** instead of a numeric value.

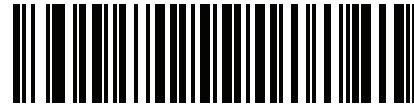

Output gender as M or F

Date Format

Use these barcodes to select the date format to display. Date fields include the following:

- **CCYY** = 4-digit year (**CC**=2-digit century [00-99], **YY**=2-digit year in the century [00-99])
- **MM** = 2-digit month [01-12]
- **DD** = 2-digit day of the month [00-31]

The default is **CCYYMMDD**.



NOTE: To specify a date separator, i.e., a character separating each field of the date, scan the **Send <character>** barcode that corresponds to the alphanumeric character to use as the date separator immediately following the date format barcode. To select no date separator, scan the **No Separator DL** parsing rule immediately following the date format barcode.

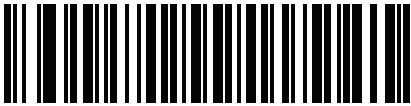

* CCYYMMDD

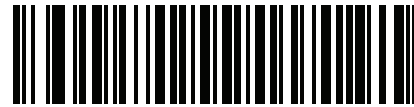

CCYYDDMM

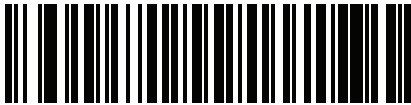

MMDDCCYY

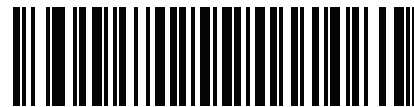

MMCCYYDD

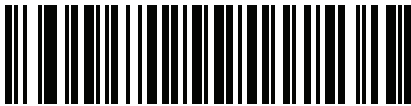

DDMMCCYY



DDCCYYMM

Date Format (continued)



YYMMDD

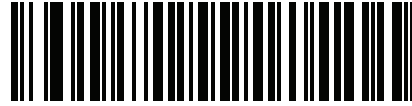

YYDDMM

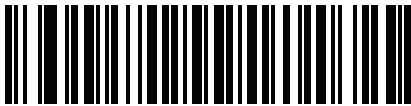

MMDDYY

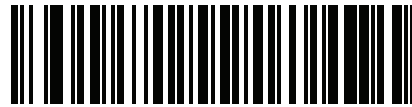

MMYYDD

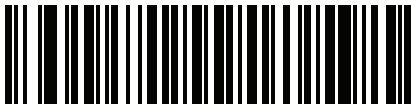

DDMMYY

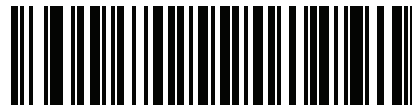

DDYYMM

No Separator

Scan this barcode immediately following a date format barcode to use no separator character between the date fields.

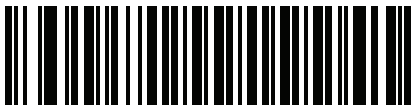

No Separator

Send Keystroke (Control Characters and Keyboard Characters)

Control Characters

Scan a **Send** barcode for the keystroke to send.



Send Control A



Send Control B



Send Control C



Send Control D



Send Control E



Send Control F



Send Control G



Send Control H

Control Characters (continued)



Send Control I



Send Control J



Send Control K



Send Control L



Send Control M



Send Control N



Send Control O



Send Control P

Control Characters (continued)



Send Control Q



Send Control R



Send Control S



Send Control T



Send Control U



Send Control V



Send Control W

Control Characters (continued)



Send Control X



Send Control Y



Send Control Z



Send Control [



**Send Control **



Send Control]

Control Characters (continued)



Send Control 6



Send Control -

Keyboard Characters

Scan a **Send** barcode for the keyboard characters to send.



Send Space



Send !



Keyboard Characters (continued)



Send \$



Send %



Send &



Send '



Send (



Send)



Send *

Keyboard Characters (continued)



Send +



Send ,



Send -



Send .



Send /



Send 0



Send 1

Keyboard Characters (continued)



Send 2



Send 3



Send 4



Send 5



Send 6



Send 7



Send 8

Keyboard Characters (continued)



Send 9



Send :



Send ;



Send <



Send =



Send >



Send ?

Keyboard Characters (continued)



Send @



Send A



Send B



Send C



Send D



Send E



Send F

Keyboard Characters (continued)



Send G



Send H



Send I



Send J



Send K



Send L



Send M

Keyboard Characters (continued)



Send N



Send O



Send P



Send Q



Send R



Send S



Send T

Keyboard Characters (continued)



Send U



Send V



Send W



Send X



Send Y



Send Z



Send [

Keyboard Characters (continued)



**Send **



Send]



Send ^



Send _



Send `



Send a



Send b

Keyboard Characters (continued)



Send c



Send d



Send e



Send f



Send g



Send h



Send i

Keyboard Characters (continued)



Send j



Send k



Send l



Send m



Send n



Send o



Send p

Keyboard Characters (continued)



Send q



Send r



Send s



Send t



Send u



Send v



Send w

Keyboard Characters (continued)



Send x



Send y



Send z



Send {



Send |



Send }



Send ~

Keyboard Characters (continued)



Send Tab Key



Send Enter Key

Parsing Rule Example

Scan the following barcodes in sequence to program the scanner to extract and transmit first, middle, and last names; mailing address line 1; mailing address line 2; mailing address city; mailing address state; mailing address postal code; and, date of birth. Then, scan a driver's license barcode.



NOTE: This example applies to RS-232. To use this example with a USB interface, enable [Function Key Mapping on page 248](#) to send the **Enter** key properly.

1



Embedded Driver's License Parsing

2



Begin New Driver's License Parse Rule

3



First Name

Parsing Rule Example (continued)

4



Send Space

5

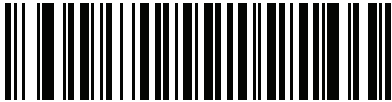

Middle Name / Initial

6



Send Space

7



Last Name

8



Send Enter Key

9



Mailing Address Line 1

Parsing Rule Example (continued)

10



Send Space

11

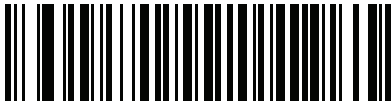

Mailing Address Line 2

12



Send Enter Key

13



Mailing Address City

14



Send Space

15

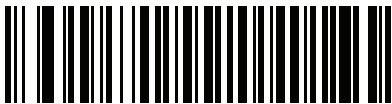

Mailing Address State

Parsing Rule Example (continued)

16



Send Space

17

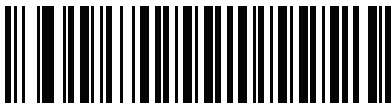

Mailing Address Postal Code

18



Send Enter Key

19



Birth Date

20



Send Enter Key

21



Save Driver's License Parse Rule

Embedded Driver's License Parsing ADF Example

This example creates a parsing rule for parsed data configured to result in the format:

Last Name, First Name

1



Begin New Driver's License Parse Rule

2



Last Name

3



Send ,

4



Send Space

5



First Name

6

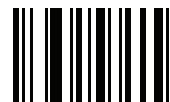

Save Driver's License Parse Rule

Then, in order to limit the full name to 15 characters, create the following ADF rule:

1



Begin New Rule

2

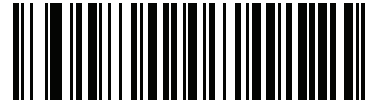

Criterion: Parsed Driver's License

3



Action: Send Next 15 Characters

4



Save Rule

For a license belonging to Michael Williams, the parsed data is Williams, Michael and Williams, Micha after applying the previous ADF rule.

Custom Tone

Introduction

The imager supports downloading a custom tone to sound when a good decode occurs. Create the audio tone according to the following specifications:

- Use a WAV audio file format; acceptable file extensions are .wav and .wave.
- Encode the audio file at 16 samples per second, i.e., 16 kHz sampling rate.
- Encode the audio file at 16 bits per sample.
- Encode the audio file with a single channel (mono).
- WAVE audio type/format = PCM (Pulse Coded Modulation).
- Ensure the audio file does not exceed 65 kBytes.
- Ensure the audio file name does not exceed 31 bytes.

Downloading a Custom Tone via 123Scan

Download the custom audio file to the imager using 123Scan. See [123Scan and Software Tools](#) for more information on this utility.

1. Download and install Zebra's 123Scan Scanner Configuration Utility from the support web site: www.zebra.com/123Scan.
2. Open 123Scan.

Figure 28 123Scan Utility

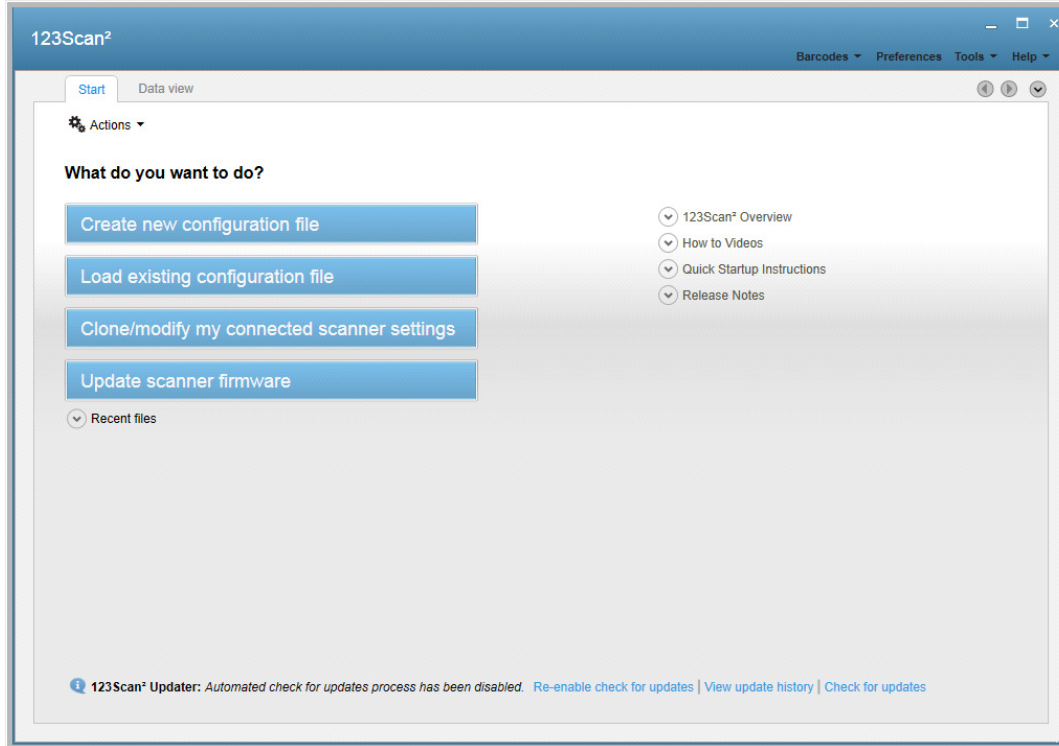

3. Select **Clone/modify my connected scanner settings**.

Figure 29 USB Parameter Change Window

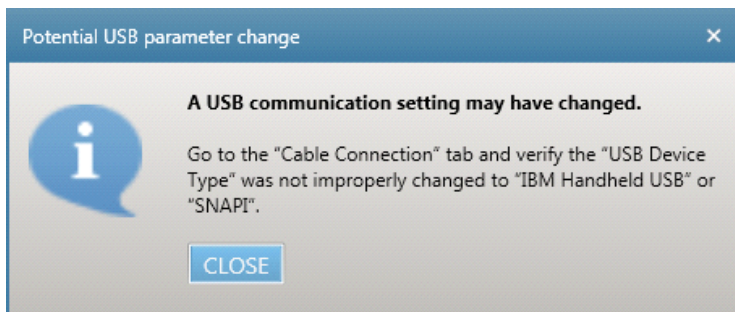

4. Select **CLOSE** on the pop-up window.

Figure 30 General Parameters Section

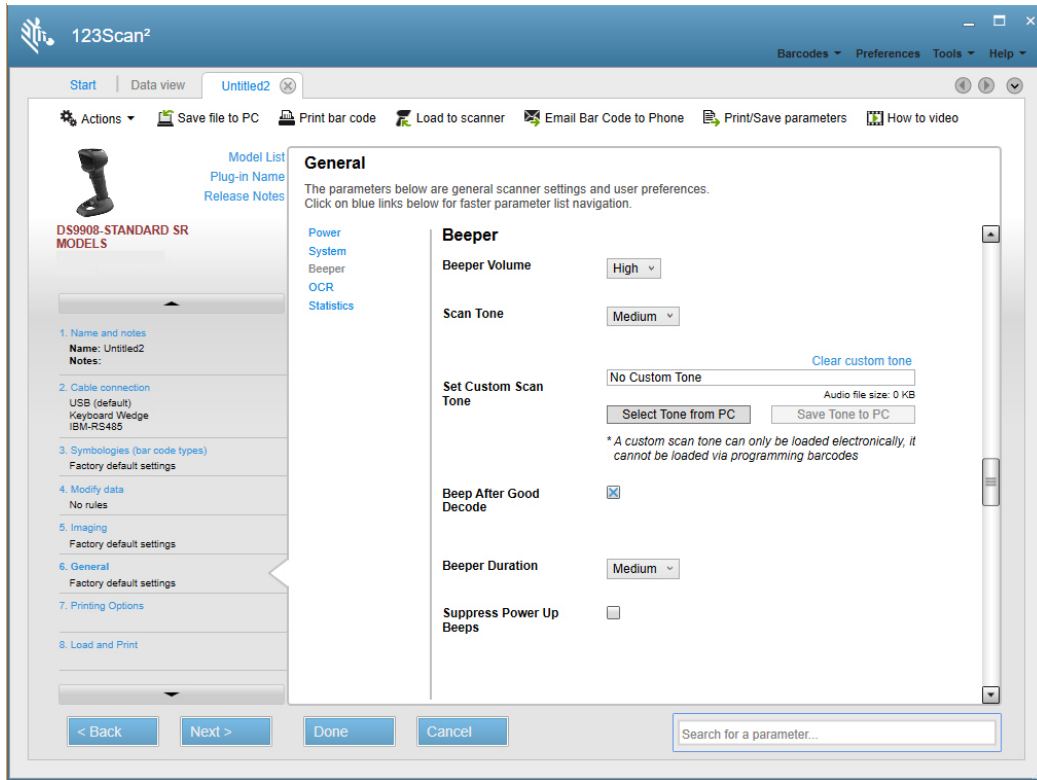

5. Select **General > Beeper**.
6. Choose the **Select Tone from PC** button to navigate to and select the custom tone.

Figure 31 Enable Custom Scan Tone Window

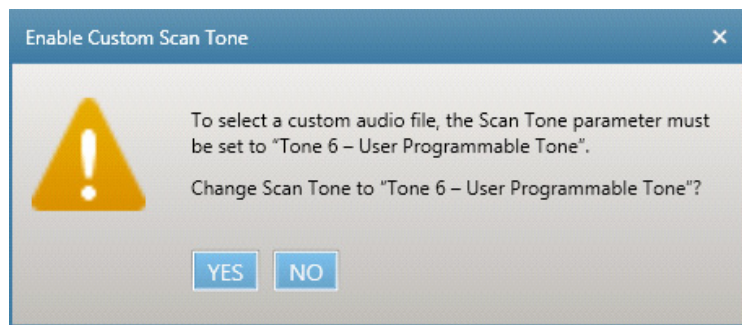

7. Select **YES** on the pop-up window to set the **Scan Tone** parameter to the **User Programmable/Tone 6** option. The **Scan Tone** field indicates **Tone 6 - User Programmable**, and the **Set Custom Scan Tone** field now reflects the selected WAV file name.

Figure 32 Updated General Parameters Section

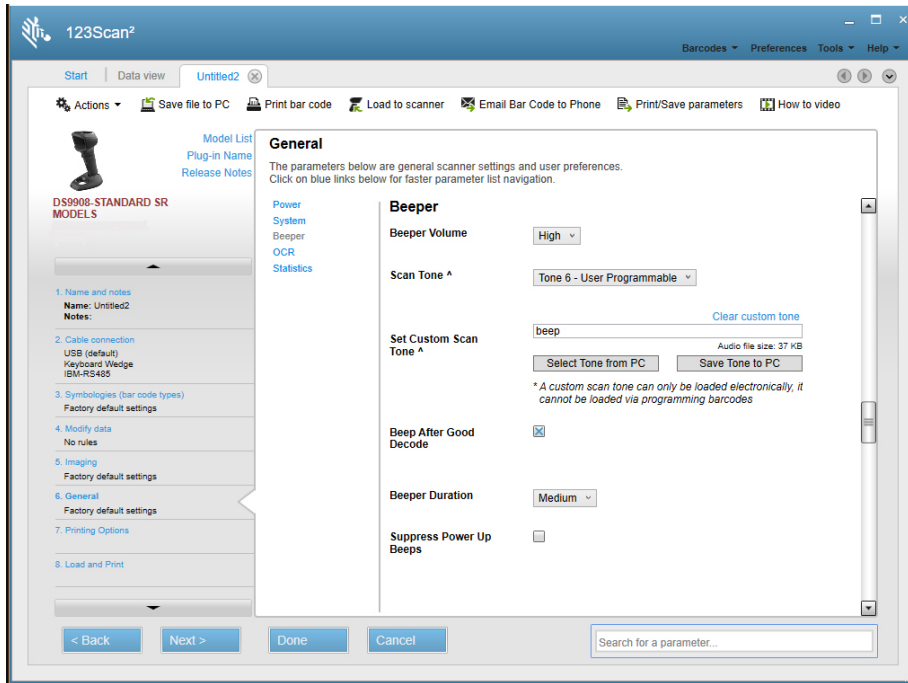

8. Select **Load to scanner** at the top of the window.

Figure 33 Load Configuration Window

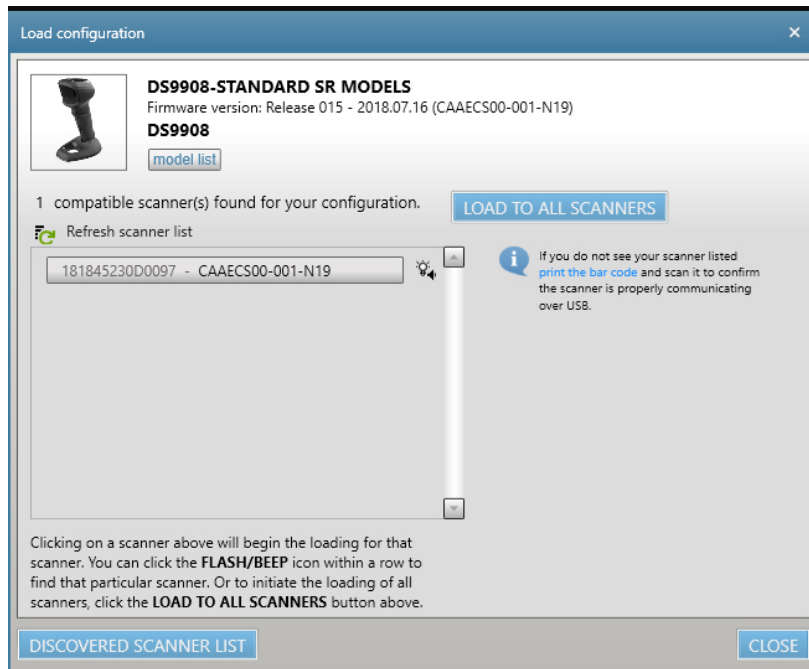

9. Select a scanner in the list, or select **LOAD TO ALL SCANNERS** to send the configuration file to all scanners listed.

Figure 34 Load Configuration Complete Window

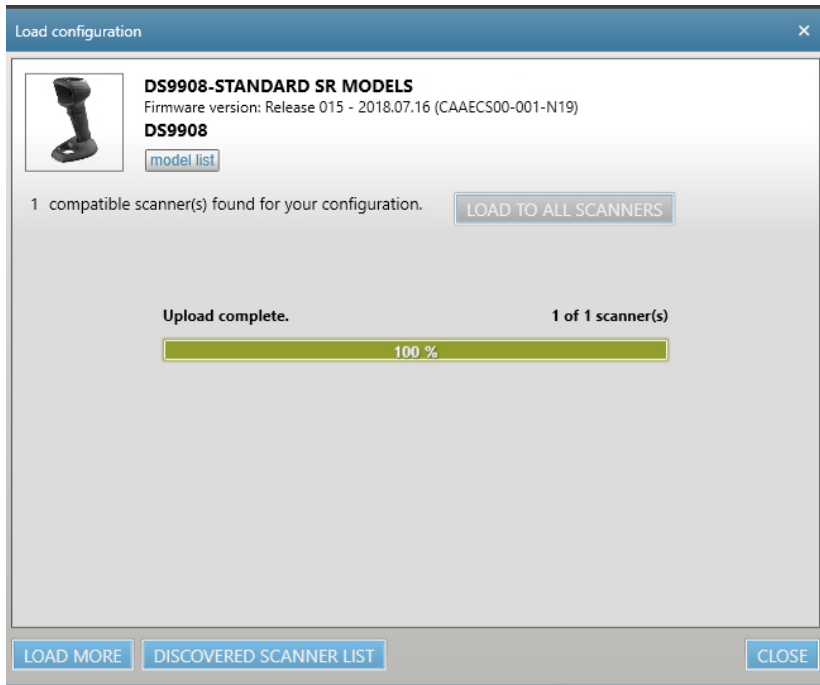

10. Select **CLOSE** when the upload completes.
11. Verify that the custom tone was successfully downloaded to the scanner by scanning a barcode.

Downloading a Custom Tone via Scanner SDK Sample Application

Download a custom audio file to the imager using the **Scanner SDK C++ Sample Application**. The user-defined tone is represented by a unique attribute number.

1. Place the imager in SNAPI USB communication mode by scanning [Symbol Native API \(SNAPI\) with Imaging Interface on page 240](#).
2. Ensure the imager is disconnected from the host PC.
3. To launch the **Scanner SDK C++ Sample Application**, on the host PC select **Start > Scanner > Scanner SDK > C++ Sample Application**.

Figure 35 Scanner SDK C++ Sample Application

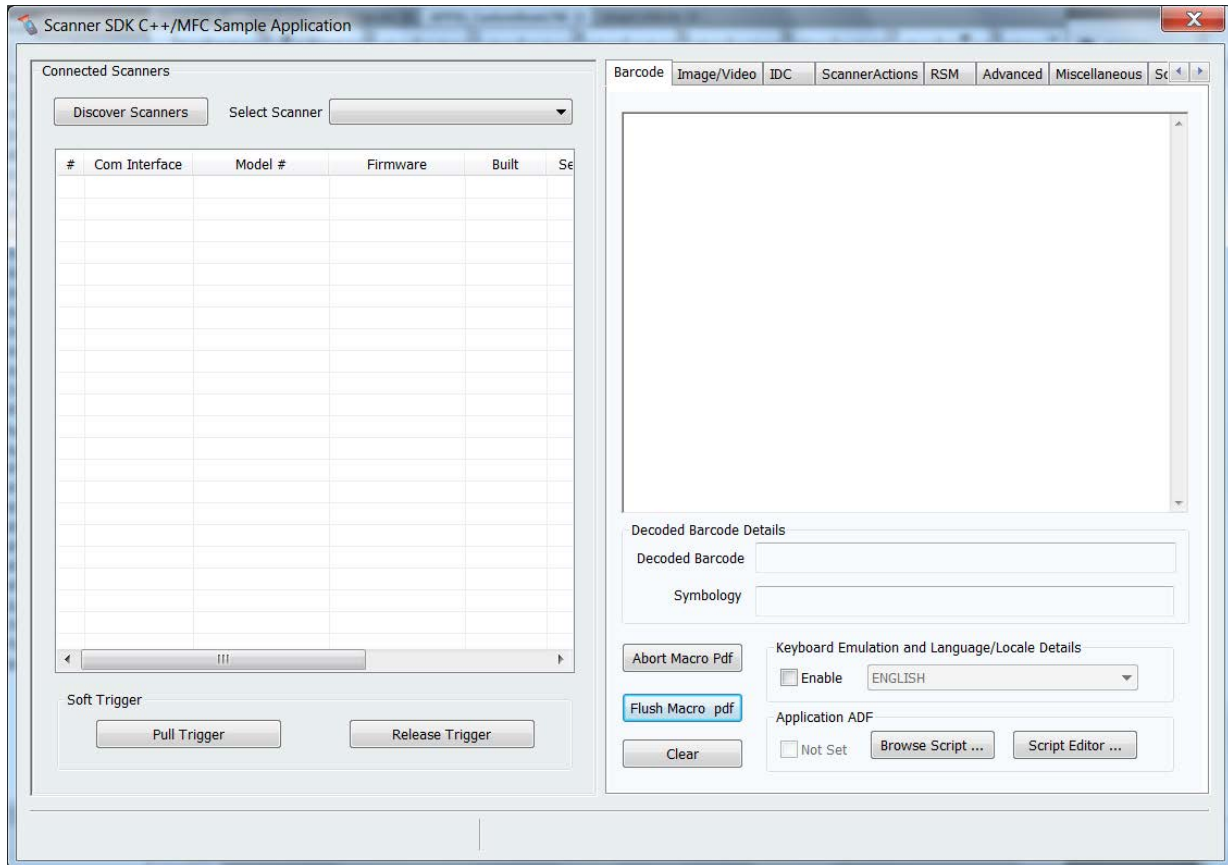

4. Connect the imager to a USB port on the PC and wait for the power-up tone.
5. Verify imager is operational by touching the trigger to turn on illumination.
6. Select **Discover Scanners** in the SDK application. The imager appears in the **Connected Scanners** list.
7. Select the **Advanced** tab.
8. In the **Custom Good Decode Tone** section of the window, select **Browse**.
9. Select the WAV file to download. Ensure the file does not exceed 65 kB.
10. Select **Upload**. After a few seconds the status bar on the bottom of the window displays **UPDATE_AUDIO_FILE - Command Success**.
11. Scan the **Scan Tone 6** barcode below to select the downloaded tone. This barcode is also available via the parameter [Beep Tone on page 65](#).



Scan Tone 6

12. Scan a barcode (e.g., the sample below) to verify that the imager sounds the downloaded scan tone.

Figure 36 Sample Barcode



NOTE: The imager sounds a system-defined tone on a good decode if you select Scan Tone 6 but did not download a custom tone.

Parameter Defaults

Table 32 Parameter Defaults

Parameter	Parameter Number ¹	SSI Number ²	Default	Page Number
Serial Number	N/A	N/A	N/A	54
Report Software Version	N/A	N/A	N/A	54
Manufacturing Information	N/A	N/A	N/A	54
Standard User Preferences				
Set Default Parameter	N/A	N/A	N/A	62
Parameter Barcode Scanning	236	ECh	Enable	63
Beep After Good Decode	56	38h	Enable	63
Beep Volume	140	8Ch	High	64
Beep Tone	145	91h	Medium	65
Beep Duration	628	F1h 74h	Short	67
Volume Adjustment Trigger Timeout	403	F0h 93h	5 Seconds	68
Suppress Power Up Beeps	721	F1h D1h	Do Not Suppress	69
Direct Decode Indicator	859	F2h 5Bh	Disable	70
Low Power Mode	128	80h	Disable	71
Time Delay to Low Power Mode	146	92h	1 Hour	72
Trigger Mode	138	8Ah	Presentation Mode	74
Hand-held Decode Aiming Pattern	306	F0h 32h	Enable	75
Presentation (Hands-free) Decode Aiming Pattern	590	F1h 4Eh	Disable Presentation (Hands-free) Decode Aiming Pattern	76

1. Parameter number decimal values are used for programming via RSM commands.

2. SSI number hex values are used for programming via SSI commands.

Parameter Defaults

Table 32 Parameter Defaults (Continued)

Parameter	Parameter Number ¹	SSI Number ²	Default	Page Number
Momentary Trigger Mode Timeout	2030	EDh	5 Seconds	77
Picklist Mode	402	F0h 92h	Enable Picklist Mode in Hand-held Mode	78
Continuous Barcode Read	649	F1h 89h	Disable	79
Unique Barcode Reporting	723	F1h D3h	Enable	79
Decode Session Timeout	136	88h	9.9 Seconds	80
Timeout Between Decodes, Same Symbol	137	89h	0.5 Seconds	80
Timeout Between Decodes, Different Symbols	144	90h	0.1 Seconds	81
Triggered Timeout, Same Symbol	724	F1h D4h	Disable	81
Mobile Phone/Display Mode	716	F1h CCh	Normal	82
PDF Prioritization	719	F1h CFh	Disable	83
PDF Prioritization Timeout	720	F1h D0h	200 ms	84
Decoding Illumination	298	F0h 2Ah	Enable	84
Illumination Brightness	669	F1h 9Dh	High	85
Motion Tolerance (Hand-held Trigger Mode Only)	858	F2h 5Ah	Less Motion Tolerance	86
Product ID (PID) Type	1281	F8h 05h 01h	Host Type Unique	86
Product ID (PID) Value	1725	F8h 06h BDh	0	87
ECLevel	1710	F8h 06h AEh	0	87
Miscellaneous Options				
Enter Key	N/A	N/A	N/A	88
Tab Key	N/A	N/A	N/A	88
Transmit Code ID Character	45	2Dh	None	89
Prefix Value	99, 105	63h, 69h	7013 <CR><LF>	90
Suffix 1 Value	98, 104	62h, 68h	7013 <CR><LF>	90
Suffix 2 Value	100, 106	64h, 6Ah		
Scan Data Transmission Format	235	EBh	Data As Is	91
FN1 Substitution Values	103, 109	67h, 6Dh	7013 <CR><LF>	93
Transmit "No Read" Message	94	5E	Disable	94

1. Parameter number decimal values are used for programming via RSM commands.

2. SSI number hex values are used for programming via SSI commands.

Parameter Defaults

Table 32 Parameter Defaults (Continued)

Parameter	Parameter Number ¹	SSI Number ²	Default	Page Number
Unsolicited Heartbeat Interval	1118	F8h 04h 5Eh	Disable	95
securPharm Decoding	1752	F8h 06h D8h	Disable	96
securPharm Output Formatting	1753	F8h 06h D9h	No Formatting	97
Image Capture Preferences				
Operational Modes	N/A	N/A	N/A	103
Image Capture Illumination	361	F0h 69h	Enable	104
Image Capture Autoexposure	360	F0h 68h	Enable	104
Fixed Exposure	567	F4h F1h 37h	100	105
Analog Gain	1232	F4h D0h	Analog Gain x 2	106
Digital Gain	1233	F4h D1h	32	106
Gain / Exposure Priority for Snapshot Mode	562	F1h 32h	Autodetect	107
Snapshot Mode Timeout	323	F0h 43h	0 (30 seconds)	108
Snapshot Aiming Pattern	300	F0h 2Ch	Enable	109
Silence Operational Mode Changes	1293	F8h 05h 0Dh	Disable (do not silence)	109
Image Cropping	301	F0h 2Dh	Disable	110
Crop to Pixel Addresses	315 316 317 318	F4h F0h 3Bh F4h F0h 3Ch F4h F0h 3Dh F4h F0h 3Eh	0 top 0 left 799 bottom 1279 right	110
Image Size (Number of Pixels)	302	F0h 2Eh	Full	112
Image Brightness (Target White)	390	F0h 86h	180	113
JPEG Image Options	299	F0h 2Bh	Quality	113
JPEG Quality Value	305	F0h 31h	65	114
JPEG Size Value	561	F1h 31h	160 kB	114
Image Enhancement	564	F1h 34h	Low (1)	115
Image File Format Selection	304	F0h 30h	JPEG	116
Image Rotation	665	F1h 99h	0	117
Bits per Pixel (BPP)	303	F0h 2Fh	8 BPP	118
Signature Capture	93	5Dh	Disable	119

1. Parameter number decimal values are used for programming via RSM commands.

2. SSI number hex values are used for programming via SSI commands.

Parameter Defaults

Table 32 Parameter Defaults (Continued)

Parameter	Parameter Number ¹	SSI Number ²	Default	Page Number
Signature Capture Image File Format Selection	313	F0h 39h	JPEG	120
Signature Capture Bits per Pixel (BPP)	314	F0h 3Ah	8 BPP	121
Signature Capture Width	366	F4h F0h 6Eh	400	122
Signature Capture Height	367	F4h F0h 6Fh	100	122
Signature Capture JPEG Quality	421	F0h A5h	65	122
Enable/Disable All Code Types				132
1D Symbologies				
UPC/EAN/JAN				
UPC-A	1	01h	Enable	132
UPC-E	2	02h	Enable	133
UPC-E1	12	0Ch	Disable	133
EAN-8/JAN 8	4	04h	Enable	134
EAN-13/JAN 13	3	03h	Enable	134
Bookland EAN	83	53h	Disable	135
Bookland ISBN Format	576	F1h 40h	ISBN-10	136
ISSN EAN	617	F1h 69h	Disable	137
Decode UPC/EAN/JAN Supplementals (2 and 5 digits)	16	10h	Ignore	138
User-Programmable Supplementals	579	F1h 43h	000	141
Supplemental 1:	580	F1h 44h		
Supplemental 2:				
UPC/EAN/JAN Supplemental Redundancy	80	50h	10	141
Decode UPC/EAN/JAN Supplemental AIM ID	672	F1h A0h	Combined	142
Transmit UPC-A Check Digit	40	28h	Enable	143
Transmit UPC-E Check Digit	41	29h	Enable	143

1. Parameter number decimal values are used for programming via RSM commands.

2. SSI number hex values are used for programming via SSI commands.

Parameter Defaults

Table 32 Parameter Defaults (Continued)

Parameter	Parameter Number ¹	SSI Number ²	Default	Page Number
Transmit UPC-E1 Check Digit	42	2Ah	Enable	144
UPC-A Preamble	34	22h	System Character	145
UPC-E Preamble	35	23h	System Character	146
UPC-E1 Preamble	36	24h	System Character	147
Convert UPC-E to UPC-A	37	25h	Disable	148
Convert UPC-E1 to UPC-A	38	26h	Disable	148
EAN/JAN Zero Extend	39	27h	Disable	149
UCC Coupon Extended Code	85	55h	Disable	149
Coupon Report	730	F1h DAh	New Coupon Format	150
UPC Reduced Quiet Zone	1289	F8h 05h 09h	Disable	151
Code 128				
Code 128	8	08h	Enable	151
Set Length(s) for Code 128	209, 210	D1h, D2h	Any Length	152
GS1-128 (formerly UCC/EAN-128)	14	0Eh	Enable	153
ISBT 128	84	54h	Enable	154
ISBT Concatenation	577	F1h 41h	Disable	154
Check ISBT Table	578	F1h 42h	Enable	155
ISBT Concatenation Redundancy	223	DFh	10	156
Code 128 <FNC4>	1254	F8h 04h E6h	Honor	156
Code 128 Security Level	751	F1h EFh	Security Level 1	157
Code 128 Reduced Quiet Zone	1208	F8h 04h B8h	Disable	158
Code 39				
Code 39	0	00h	Enable	158
Trioptic Code 39	13	0Dh	Disable	159
Convert Code 39 to Code 32 (Italian Pharmacy Code)	86	56h	Disable	159
Code 32 Prefix	231	E7h	Disable	160
Set Length(s) for Code 39	18, 19	12h, 13h	1 to 55	160

1. Parameter number decimal values are used for programming via RSM commands.

2. SSI number hex values are used for programming via SSI commands.

Parameter Defaults

Table 32 Parameter Defaults (Continued)

Parameter	Parameter Number ¹	SSI Number ²	Default	Page Number
Code 39 Check Digit Verification	48	30h	Disable	162
Transmit Code 39 Check Digit	43	2Bh	Disable	162
Code 39 Full ASCII Conversion	17	11h	Disable	163
Code 39 Security Level	750	F1h EEh	Security Level 1	164
Code 39 Reduced Quiet Zone	1209	F8h 04h B9h	Disable	165
Code 93				
Code 93	9	09h	Enable	165
Set Length(s) for Code 93	26, 27	1Ah, 1Bh	1 to 55	166
Code 11				
Code 11	10	0Ah	Disable	168
Set Lengths for Code 11	28, 29	1Ch, 1Dh	4 to 55	168
Code 11 Check Digit Verification	52	34h	Disable	170
Transmit Code 11 Check Digit(s)	47	2Fh	Disable	171
Interleaved 2 of 5 (ITF)				
Interleaved 2 of 5 (ITF)	6	06h	Enable	171
Set Lengths for I 2 of 5	22, 23	16h, 17h	6 to 55	172
I 2 of 5 Check Digit Verification	49	31h	Disable	173
Transmit I 2 of 5 Check Digit	44	2Ch	Disable	174
Convert I 2 of 5 to EAN 13	82	52h	Disable	174
Febraban	1750	F8h 06h D6h	Disable	175
I 2 of 5 Security Level	1121	F8h 04h 61h	Security Level 1	176
I 2 of 5 Reduced Quiet Zone	1210	F8h 04h BAh	Disable	177
Discrete 2 of 5 (DTF)				
Discrete 2 of 5	5	05h	Disable	177
Set Length(s) for D 2 of 5	20, 21	14h 15h	1 to 55	178
Codabar (NW - 7)				
Codabar	7	07h	Enable	180

1. Parameter number decimal values are used for programming via RSM commands.

2. SSI number hex values are used for programming via SSI commands.

Parameter Defaults

Table 32 Parameter Defaults (Continued)

Parameter	Parameter Number ¹	SSI Number ²	Default	Page Number
Set Lengths for Codabar	24, 25	18h, 19h	4 to 55	180
CLSI Editing	54	36h	Disable	182
NOTIS Editing	55	37h	Disable	182
Codabar Security Level	1776	F8h 06h F0h	Security Level 1	183
Codabar Upper or Lower Case Start/ Stop Characters Detection	855	F2h 57h	Upper Case	184
Codabar Mod 16 Check Digit Verification	1784	F8h 06h F8h	Disable	184
Transmit Codabar Check Digit	704	F1h C0h	Disable	185
MSI				
MSI	11	0Bh	Disable	185
Set Length(s) for MSI	30, 31	1Eh, 1Fh	4 to 55	186
MSI Check Digits	50	32h	One MSI Check Digit	188
Transmit MSI Check Digit	46	2Eh	Disable	188
MSI Check Digit Algorithm	51	33h	Mod 10/Mod 10	190
MSI Reduced Quiet Zone	1392	F8h 05h 70h	Disable	190
Chinese 2 of 5				
Chinese 2 of 5	408	F0h 98h	Disable	191
Matrix 2 of 5				
Matrix 2 of 5	618	F1h 6Ah	Disable	191
Matrix 2 of 5 Lengths	619 620	F1h 6Bh F1h 6Ch	4 to 55	192
Matrix 2 of 5 Check Digit	622	F1h 6Eh	Disable	194
Transmit Matrix 2 of 5 Check Digit	623	F1h 6Fh	Disable	194
Korean 3 of 5				
Korean 3 of 5	581	F1h 45h	Disable	195
Inverse 1D				
Inverse 1D	586	F1h 4Ah	Regular	195

1. Parameter number decimal values are used for programming via RSM commands.

2. SSI number hex values are used for programming via SSI commands.

Parameter Defaults

Table 32 Parameter Defaults (Continued)

Parameter	Parameter Number ¹	SSI Number ²	Default	Page Number
GS1 DataBar				
GS1 DataBar Omnidirectional (formerly GS1 DataBar-14), GS1 DataBar Truncated, GS1 DataBar Stacked, GS1 DataBar Stacked Omnidirectional	338	F0h 52h	Enable	197
GS1 DataBar Limited	339	F0h 53h	Enable	198
GS1 DataBar Expanded, GS1 DataBar Expanded Stacked	340	F0h 54h	Enable	198
Convert GS1 DataBar to UPC/EAN/JAN	397	F0h 8Dh	Disable	199
GS1 DataBar Security Level	1706	F8h 06h AAh	Level 1	200
GS1 DataBar Limited Margin Check	728	F1h D8h	Level 3	201
Symbology-Specific Security Features				
Redundancy Level	78	4Eh	1	202
Security Level	77	4Dh	1	204
1D Quiet Zone Level	1288	F8h 05h 08h	1	205
Intercharacter Gap Size	381	F0h 7Dh	Normal	206
Composite Codes				
Composite CC-C	341	F0h 55h	Disable	206
Composite CC-A/B	342	F0h 56h	Disable	207
Composite TLC-39	371	F0h 73h	Disable	207
Composite Inverse	1113	F8h 04h 59h	Regular Only	207
UPC Composite Mode	344	F0h 58h	UPC Never Linked	209
Composite Beep Mode	398	F0h 8Eh	Beep As Each Code Type is Decoded	210
GS1-128 Emulation Mode for UCC/EAN Composite Codes	427	F0h ABh	Disable	210
<p>1. Parameter number decimal values are used for programming via RSM commands.</p> <p>2. SSI number hex values are used for programming via SSI commands.</p>				

Parameter Defaults

Table 32 Parameter Defaults (Continued)

Parameter	Parameter Number ¹	SSI Number ²	Default	Page Number
2D Symbolologies				
PDF417	15	0Fh	Enable	211
MicroPDF417	227	E3h	Disable	211
Code 128 Emulation	123	7Bh	Disable	212
Data Matrix	292	F0h 24h	Enable	213
GS1 Data Matrix	1336	F8h 05h 38h	Disable	213
Data Matrix Inverse	588	F1h 4Ch	Inverse Autodetect	214
Decode Data Matrix Mirror Images	537	F1h 19h	Auto	215
Maxicode	294	F0h 26h	Disable	216
QR Code	293	F0h 25h	Enable	216
Weblink QR	1947	F7 07 9B	Enable	217
GS1 QR	1343	F8h 05h 3Fh	Enable	218
MicroQR	573	F1h 3Dh	Enable	218
Linked QR Mode	1847	737h	Linked QR Only	219
Aztec	574	F1h 3Eh	Enable	220
Aztec Inverse	589	F1h 4Dh	Inverse Autodetect	220
Han Xin	1167	F8h 04h 8Fh	Disable	221
Han Xin Inverse	1168	F8h 04h 90h	Regular	221
Grid Matrix	1718	F8h 06h B6h	Disable	222
Grid Matrix Inverse	1719	F8h 06h B7h	Regular Only	222
Grid Matrix Mirror	1736	F8h 06h C8h	Regular Only	223
DotCode	1906	F8 07 72h	Disable	224
DotCode Inverse	1907	F8 07 73h	Inverse Autodetect	225
DotCode Mirrored	1908	F8 07 74h	Autodetect	226
DotCode Prioritize	1937	F8 07 91h	Enable	227
Macro PDF				
Flush Macro PDF Buffer	N/A	N/A	N/A	228
Abort Macro PDF Entry	N/A	N/A	N/A	228

1. Parameter number decimal values are used for programming via RSM commands.

2. SSI number hex values are used for programming via SSI commands.

Table 32 Parameter Defaults (Continued)

Parameter	Parameter Number ¹	SSI Number ²	Default	Page Number
Postal Codes				
US Postnet	89	59h	Disable	228
US Planet	90	5Ah	Disable	229
Transmit US Postal Check Digit	95	5Fh	Enable	229
UK Postal	91	5Bh	Disable	230
Transmit UK Postal Check Digit	96	60h	Enable	230
Japan Postal	290	F0h 22h	Disable	231
Australia Post	291	F0h 23h	Disable	231
Australia Post Format	718	F1h CEh	Autodiscriminate	232
Netherlands KIX Code	326	F0h 46h	Disable	233
USPS 4CB/One Code/Intelligent Mail	592	F1h 50h	Disable	233
UPU FICS Postal	611	F1h 63h	Disable	234
Mailmark	1337	F8h 05h 39h	Disable	234
USB Host Parameters				
USB Device Type	N/A	N/A	USB Keyboard HID	239
Symbol Native API (SNAPI) Status Handshaking	N/A	N/A	Enable	241
USB Keystroke Delay	N/A	N/A	No Delay	241
USB Caps Lock Override	N/A	N/A	Disable	242
Barcodes with Unknown Characters	N/A	N/A	Send Barcodes with Unknown Characters	242
USB Convert Unknown to Code 39	N/A	N/A	Disable	243
USB Fast HID	N/A	N/A	Enable	243
USB Polling Interval	N/A	N/A	3 msec	244
Keypad Emulation	N/A	N/A	Enable	246
Quick Keypad Emulation	N/A	N/A	Enable	246
Keypad Emulation with Leading Zero	N/A	N/A	Enable	247
USB FN1 Substitution	N/A	N/A	Disable	247

1. Parameter number decimal values are used for programming via RSM commands.

2. SSI number hex values are used for programming via SSI commands.

Parameter Defaults

Table 32 Parameter Defaults (Continued)

Parameter	Parameter Number ¹	SSI Number ²	Default	Page Number
Function Key Mapping	N/A	N/A	Disable	248
Simulated Caps Lock	N/A	N/A	Disable	248
Convert Case	N/A	N/A	None	249
USB Static CDC	N/A	N/A	Enable	250
CDC Beep on <BEL>	N/A	N/A	Enable	250
TGCS (IBM) USB Beep Directive	N/A	N/A	Ignore	250
TGCS (IBM) USB Barcode Configuration Directive	N/A	N/A	Ignore	251
TGCS (IBM) USB Specification Version	N/A	N/A	Version 2.2	251
USB CDC Host Variant	1713	F8 06 B1	Standard CDC	252
SSI Host Parameters				
Select SSI Host	N/A	N/A	N/A	267
Baud Rate	156	9Ch	9600	267
Parity	158	9Eh	None	269
Check Parity	151	97h	Disable	270
Stop Bits	157	9Dh	1	270
Software Handshaking	159	9Fh	ACK/NAK	271
Host RTS Line State	154	9Ah	Low	272
Decode Data Packet Format	238	EEh	Send Raw Decode Data	273
Host Serial Response Timeout	155	9Bh	Low - 2 Seconds	274
Host Character Timeout	239	EFh	Low - 200 msec	275
Multipacket Option	334	F0h 4Eh	Multipacket Option 1	276
Interpacket Delay	335	F0h 4Fh	Minimum - 0 msec	277
Event Reporting				
Decode Event	256	F0h 00h	Disable	278
Boot Up Event	258	F0h 02h	Disable	279
Parameter Event	259	F0h 03h	Disable	280
RS-232 Host Parameters				
RS-232 Host Types	N/A	N/A	Standard	286

1. Parameter number decimal values are used for programming via RSM commands.

2. SSI number hex values are used for programming via SSI commands.

Parameter Defaults

Table 32 Parameter Defaults (Continued)

Parameter	Parameter Number ¹	SSI Number ²	Default	Page Number
Baud Rate	N/A	N/A	9600	288
Parity	N/A	N/A	None	289
Stop Bits	N/A	N/A	1 Stop Bit	289
Data Bits	N/A	N/A	8-bit	290
Check Receive Errors	N/A	N/A	Enable	290
Hardware Handshaking	N/A	N/A	None	291
Software Handshaking	N/A	N/A	None	293
Host Serial Response Timeout	N/A	N/A	2 Seconds	295
RTS Line State	N/A	N/A	Low RTS	296
Beep on <BEL>	N/A	N/A	Disable	296
Intercharacter Delay	N/A	N/A	0 msec	297
Nixdorf Beep/LED Options	N/A	N/A	Normal Operation	298
Barcodes with Unknown Characters	N/A	N/A	Send Barcode With Unknown Characters	298
IBM 468X/469X Host Parameters				
Port Address	N/A	N/A	None	303
Convert Unknown to Code 39	N/A	N/A	Disable	304
RS-485 Beep Directive	N/A	N/A	Ignore	304
RS-485 Barcode Configuration Directive	N/A	N/A	Ignore	305
IBM-485 Specification Version	N/A	N/A	Original Specification	305
Keyboard Wedge Host Parameters				
Keyboard Wedge Host Type	N/A	N/A	IBM AT Notebook	309
Barcodes with Unknown Characters	N/A	N/A	Send Barcodes with Unknown Characters	309
Keystroke Delay	N/A	N/A	No Delay	310
Intra-keystroke Delay	N/A	N/A	Disable	310
Alternate Numeric Keypad Emulation	N/A	N/A	Enable	311
Quick Keypad Emulation	N/A	N/A	Enable	311

1. Parameter number decimal values are used for programming via RSM commands.

2. SSI number hex values are used for programming via SSI commands.

Parameter Defaults

Table 32 Parameter Defaults (Continued)

Parameter	Parameter Number ¹	SSI Number ²	Default	Page Number
Simulated Caps Lock	N/A	N/A	Disable	312
Caps Lock Override	N/A	N/A	Disable	313
Convert Case	N/A	N/A	Do Not Convert	313
Function Key Mapping	N/A	N/A	Disable	314
FN1 Substitution	N/A	N/A	Disable	314
Send Make and Break	N/A	N/A	Send Make and Break Scan Codes	315
OCR Programming Parameters				
OCR-A	680	F1h A8h	Disable	319
OCR-A Variant	684	F1h ACh	OCR-A Full ASCII	320
OCR-B	681	F1h A9h	Disable	321
OCR-B Variant	685	F1h ADh	OCR-B Full ASCII	322
MICR E13B	682	F1h AAh	Disable	326
US Currency Serial Number	683	F1h ABh	Disable	327
OCR Orientation	687	F1h AFh	0°	327
OCR Lines	691	F1h B3h	1	329
OCR Minimum Characters	689	F1h B1h	3	329
OCR Maximum Characters	690	F1h B2h	100	330
OCR Subset	686	F1h AEh	Selected font variant	330
OCR Quiet Zone	695	F1h B7h	50	331
OCR Template	547	F1h 23h	99999999	331
OCR Check Digit Modulus	688	F1h B0h	1	341
OCR Check Digit Multiplier	700	F1h BCh	121212121212	341
OCR Check Digit Validation	694	F1h B6h	None	342
Inverse OCR	856	F2h 58h	Regular	348
OCR Redundancy	1770	F8h 06h EAh	Level 1	349
Intelligent Document Capture (IDC) Parameters				
IDC Operating Mode	594	F1h 52h	Off	355
IDC Symbology	655	F1h 8Fh	001	356

1. Parameter number decimal values are used for programming via RSM commands.

2. SSI number hex values are used for programming via SSI commands.

Parameter Defaults

Table 32 Parameter Defaults (Continued)

Parameter	Parameter Number ¹	SSI Number ²	Default	Page Number
IDC X Coordinate	596	F4h F1h 54h	-151	357
IDC Y Coordinate	597	F4h F1h 55h	-050	357
IDC Width	598	F1h 56h	0300	358
IDC Height	599	F1h 57h	0050	358
IDC Aspect	595	F1h 53h	000	359
IDC File Format Selector	601	F1h 59h	JPEG	359
IDC Bits Per Pixel	602	F1h 5Ah	8 BPP	360
IDC JPEG Quality	603	F1h 5Bh	065	360
IDC Find Box Outline	727	F1h D7h	Disable	361
IDC Minimum Text Length	656	F1h 90h	00	361
IDC Maximum Text Length	657	F1h 91h	00	362
IDC Captured Image Brighten	654	F1h 8Eh	Enable	362
IDC Captured Image Sharpen	658	F1h 92h	Enable	363
IDC Border Type	829	F2h 3Dh	None	364
IDC Delay Time	830	F2h 3Eh	000	365
IDC Zoom Limit	651	F1h 8Bh	000	365
IDC Maximum Rotation	652	F1h 8Ch	00	366
Digimarc Digital Watermarks				
Digimarc Digital Watermarks/DW	1687	F8h 06h 97h	Enable	371
DL Parsing Parameters				
Driver's License Parsing	N/A	N/A	No Driver's License Parsing	378
Parsing Driver's License Data Fields	N/A	N/A	N/A	379
Driver's License Parse Field Barcodes	N/A	N/A	N/A	380
AAMVA Parse Field Barcodes	N/A	N/A	N/A	382
Parser Version ID Barcode	N/A	N/A	N/A	391
Set Default Parameter	N/A	N/A	N/A	392
Output Gender as M or F	N/A	N/A	N/A	392
Date Format	N/A	N/A	CCYYMMDD	393

1. Parameter number decimal values are used for programming via RSM commands.

2. SSI number hex values are used for programming via SSI commands.

Table 32 Parameter Defaults (Continued)

Parameter	Parameter Number ¹	SSI Number ²	Default	Page Number
No Separator	N/A	N/A	N/A	394
Send Keystroke Control Characters Keyboard Characters	N/A	N/A	N/A	395
Parsing Rule Example	N/A	N/A	N/A	413
Embedded Driver's License Parsing ADF Example	N/A	N/A	N/A	417

1. Parameter number decimal values are used for programming via RSM commands.

2. SSI number hex values are used for programming via SSI commands.

Numeric Barcodes

Cancel

To correct an error or change a selection, scan the barcode below.



Cancel

Numeric Barcodes

For parameters requiring specific numeric values, scan the appropriately numbered barcode(s).



0



1



2



3

Numeric Barcodes (continued)

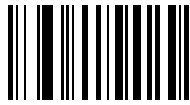

4



5



6

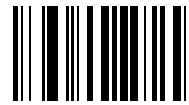

7

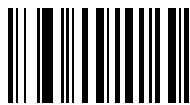

8

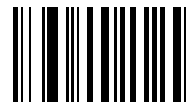

9

Alphanumeric Barcodes

Cancel

To correct an error or change a selection, scan the following barcode.



Cancel

Alphanumeric Barcodes



Space

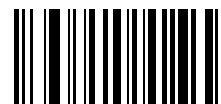

#



\$

Alphanumeric Barcodes (continued)



*

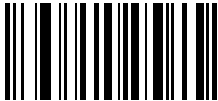

%



+



-



.



/

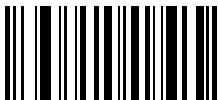

!

Alphanumeric Barcodes (continued)



“

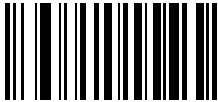

&



’

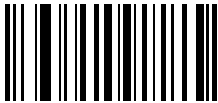

(

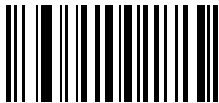

)

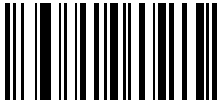

:

Alphanumeric Barcodes (continued)

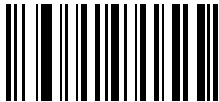

;

Alphanumeric Barcodes



=



<



>



?

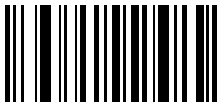

@



[

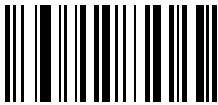

\

Alphanumeric Barcodes (continued)

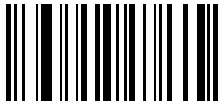

1

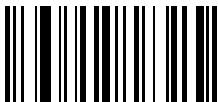

2

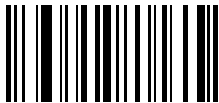

3



4

Alphanumeric Barcodes (continued)



NOTE: Do not confuse the following barcodes with those on the numeric keypad.



0

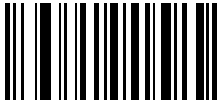

1



2

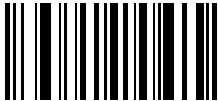

3



4



5

Alphanumeric Barcodes (continued)



6



7



8



9



End of Message



Cancel

Alphanumeric Barcodes (continued)



A

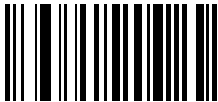

B

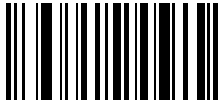

C

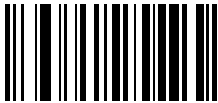

D



E

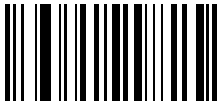

F

Alphanumeric Barcodes (continued)

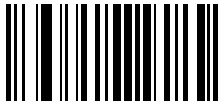

G



H

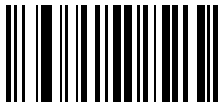

I



J

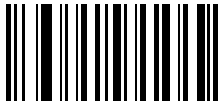

K

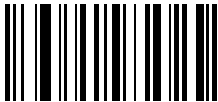

L

Alphanumeric Barcodes (continued)

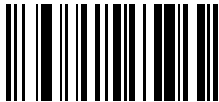

M



N



O



P

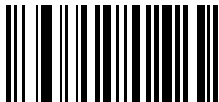

Q

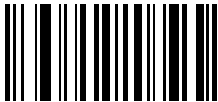

R

Alphanumeric Barcodes (continued)



S

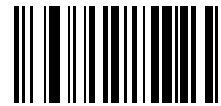

T



U



V



W

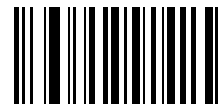

X

Alphanumeric Barcodes (continued)

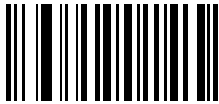

Y

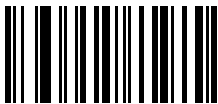

Z

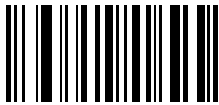

a



b



c

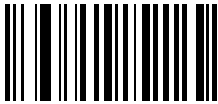

d

Alphanumeric Barcodes (continued)



e

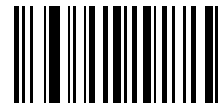

f

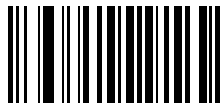

g

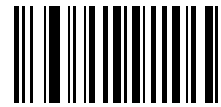

h



i



j

Alphanumeric Barcodes (continued)



k

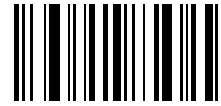

l



m

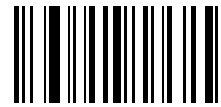

n



o

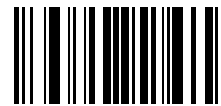

p

Alphanumeric Barcodes (continued)



q

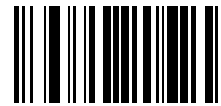

r



s

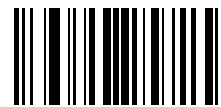

t



u

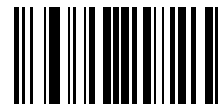

v

Alphanumeric Barcodes (continued)

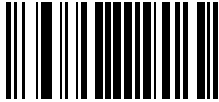

w

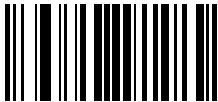

x

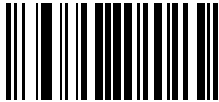

y

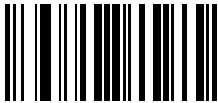

z



{

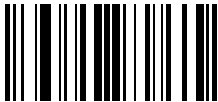

|

Alphanumeric Barcodes (continued)

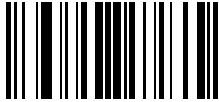

}

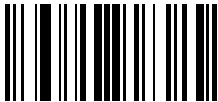

~

ASCII Character Sets

Introduction



NOTE: For the Keyboard Wedge Interface, Code 39 Full ASCII interprets the barcode special character (\$ + % /) preceding a Code 39 character and assigns an ASCII character value to the pair. For example, if you enable Code 39 Full ASCII and scan **+B**, it transmits as **b**, **%J** as **?**, and **%V** as **@**. Scanning **ABC%i** outputs the keystroke equivalent of **ABC >**.

Table 33 ASCII Character Set

ASCII Value (Prefix/Suffix Value)	Full ASCII Code 39 Encode Char	Keystroke	ASCII Character (Applies to RS-232 Only)
1000	%U	CTRL 2	NUL
1001	\$A	CTRL A	SOH
1002	\$B	CTRL B	STX
1003	\$C	CTRL C	ETX
1004	\$D	CTRL D	EOT
1005	\$E	CTRL E	ENQ
1006	\$F	CTRL F	ACK
1007	\$G	CTRL G	BELL
1008	\$H	CTRL H/ BACKSPACE ¹	BCKSPC
1009	\$I	CTRL I/ HORIZONTAL TAB ¹	HORIZ TAB
1010	\$J	CTRL J	LF/NW LN
1011	\$K	CTRL K	VT
1012	\$L	CTRL L	FF
1013	\$M	CTRL M/ ENTER ¹	CR/ENTER
1014	\$N	CTRL N	SO

¹The keystroke in bold transmits only if you enabled [Function Key Mapping on page 248](#) or [Function Key Mapping on page 314](#). Otherwise, the unbold keystroke transmits.

ASCII Character Sets

Table 33 ASCII Character Set (Continued)

ASCII Value (Prefix/Suffix Value)	Full ASCII Code 39 Encode Char	Keystroke	ASCII Character (Applies to RS-232 Only)
1015	\$O	CTRL O	SI
1016	\$P	CTRL P	DLE
1017	\$Q	CTRL Q	DC1/XON
1018	\$R	CTRL R	DC2
1019	\$S	CTRL S	DC3/XOFF
1020	\$T	CTRL T	DC4
1021	\$U	CTRL U	NAK
1022	\$V	CTRL V	SYN
1023	\$W	CTRL W	ETB
1024	\$X	CTRL X	CAN
1025	\$Y	CTRL Y	EM
1026	\$Z	CTRL Z	SUB
1027	%A	CTRL [ESC
1028	%B	CTRL \	FS
1029	%C	CTRL]	GS
1030	%D	CTRL 6	RS
1031	%E	CTRL -	US
1032	Space	Space	Space
1033	/A	!	!
1034	/B	"	"
1035	/C	#	#
1036	/D	\$	\$
1037	/E	%	%
1038	/F	&	&
1039	/G	'	'
1040	/H	((
1041	/I))
1042	/J	*	*
1043	/K	+	+

¹The keystroke in bold transmits only if you enabled [Function Key Mapping on page 248](#) or [Function Key Mapping on page 314](#). Otherwise, the unbold keystroke transmits.

ASCII Character Sets

Table 33 ASCII Character Set (Continued)

ASCII Value (Prefix/Suffix Value)	Full ASCII Code 39 Encode Char	Keystroke	ASCII Character (Applies to RS-232 Only)
1044	/L	,	,
1045	-	-	-
1046	.	.	.
1047	/o	/	/
1048	0	0	0
1049	1	1	1
1050	2	2	2
1051	3	3	3
1052	4	4	4
1053	5	5	5
1054	6	6	6
1055	7	7	7
1056	8	8	8
1057	9	9	9
1058	/Z	:	:
1059	%F	;	;
1060	%G	<	<
1061	%H	=	=
1062	%I	>	>
1063	%J	?	?
1064	%V	@	@
1065	A	A	A
1066	B	B	B
1067	C	C	C
1068	D	D	D
1069	E	E	E
1070	F	F	F
1071	G	G	G
1072	H	H	H

¹The keystroke in bold transmits only if you enabled [Function Key Mapping on page 248](#) or [Function Key Mapping on page 314](#). Otherwise, the unbold keystroke transmits.

ASCII Character Sets

Table 33 ASCII Character Set (Continued)

ASCII Value (Prefix/Suffix Value)	Full ASCII Code 39 Encode Char	Keystroke	ASCII Character (Applies to RS-232 Only)
1073	I	I	I
1074	J	J	J
1075	K	K	K
1076	L	L	L
1077	M	M	M
1078	N	N	N
1079	O	O	O
1080	P	P	P
1081	Q	Q	Q
1082	R	R	R
1083	S	S	S
1084	T	T	T
1085	U	U	U
1086	V	V	V
1087	W	W	W
1088	X	X	X
1089	Y	Y	Y
1090	Z	Z	Z
1091	%K	[[
1092	%L	\	\
1093	%M]]
1094	%N	^	^
1095	%O	_	_
1096	%W	'	'
1097	+A	a	a
1098	+B	b	b
1099	+C	c	c
1100	+D	d	d
1101	+E	e	e

¹The keystroke in bold transmits only if you enabled [Function Key Mapping on page 248](#) or [Function Key Mapping on page 314](#). Otherwise, the unbold keystroke transmits.

ASCII Character Sets

Table 33 ASCII Character Set (Continued)

ASCII Value (Prefix/Suffix Value)	Full ASCII Code 39 Encode Char	Keystroke	ASCII Character (Applies to RS-232 Only)
1102	+F	f	f
1103	+G	g	g
1104	+H	h	h
1105	+I	i	i
1106	+J	j	j
1107	+K	k	k
1108	+L	l	l
1109	+M	m	m
1110	+N	n	n
1111	+O	o	o
1112	+P	p	p
1113	+Q	q	q
1114	+R	r	r
1115	+S	s	s
1116	+T	t	t
1117	+U	u	u
1118	+V	v	v
1119	+W	w	w
1120	+X	x	x
1121	+Y	y	y
1122	+Z	z	z
1123	%P	{	{
1124	%Q	 	
1125	%R	}	}
1126	%S	~	~
1127			Undefined
7013			ENTER

¹The keystroke in bold transmits only if you enabled [Function Key Mapping on page 248](#) or [Function Key Mapping on page 314](#). Otherwise, the unbold keystroke transmits.

Table 34 ALT Key Character Set

ALT Keys	Keystroke
2064	ALT 2
2065	ALT A
2066	ALT B
2067	ALT C
2068	ALT D
2069	ALT E
2070	ALT F
2071	ALT G
2072	ALT H
2073	ALT I
2074	ALT J
2075	ALT K
2076	ALT L
2077	ALT M
2078	ALT N
2079	ALT O
2080	ALT P
2081	ALT Q
2082	ALT R
2083	ALT S
2084	ALT T
2085	ALT U
2086	ALT V
2087	ALT W
2088	ALT X
2089	ALT Y
2090	ALT Z

Table 35 GUI Key Character Set

GUI Key	Keystroke
3000	Right Control Key
3048	GUI 0
3049	GUI 1
3050	GUI 2
3051	GUI 3
3052	GUI 4
3053	GUI 5
3054	GUI 6
3055	GUI 7
3056	GUI 8
3057	GUI 9
3065	GUI A
3066	GUI B
3067	GUI C
3068	GUI D
3069	GUI E
3070	GUI F
3071	GUI G
3072	GUI H
3073	GUI I
3074	GUI J
3075	GUI K
3076	GUI L
3077	GUI M
3078	GUI N
3079	GUI O
3080	GUI P
3081	GUI Q
3082	GUI R

Note: GUI Shift Keys - The Apple TM iMac keyboard has an apple key on either side of the space bar. Windows-based systems have a GUI key to the left of the left ALT key, and to the right of the right ALT key.

Table 35 GUI Key Character Set (Continued)

GUI Key	Keystroke
3083	GUI S
3084	GUI T
3085	GUI U
3086	GUI V
3087	GUI W
3088	GUI X
3089	GUI Y
3090	GUI Z

Note: GUI Shift Keys - The Apple [™] iMac keyboard has an apple key on either side of the space bar. Windows-based systems have a GUI key to the left of the left ALT key, and to the right of the right ALT key.

Table 36 PF Key Character Set

PF Keys	Keystroke
4001	PF 1
4002	PF 2
4003	PF 3
4004	PF 4
4005	PF 5
4006	PF 6
4007	PF 7
4008	PF 8
4009	PF 9
4010	PF 10
4011	PF 11
4012	PF 12
4013	PF 13
4014	PF 14
4015	PF 15
4016	PF 16

Table 37 F Key Character Set

F Keys	Keystroke
5001	F 1
5002	F 2
5003	F 3
5004	F 4
5005	F 5
5006	F 6
5007	F 7
5008	F 8
5009	F 9
5010	F 10
5011	F 11
5012	F 12
5013	F 13
5014	F 14
5015	F 15
5016	F 16
5017	F 17
5018	F 18
5019	F 19
5020	F 20
5021	F 21
5022	F 22
5023	F 23
5024	F 24

Table 38 Numeric Key Character Set

Numeric Keypad	Keystroke
6042	*
6043	+
6044	Undefined
6045	-

Table 38 Numeric Key Character Set (Continued)

Numeric Keypad	Keystroke
6046	.
6047	/
6048	0
6049	1
6050	2
6051	3
6052	4
6053	5
6054	6
6055	7
6056	8
6057	9
6058	Enter
6059	Num Lock

Table 39 Extended Key Character Set

Extended Keypad	Keystroke
7001	Break
7002	Delete
7003	Pg Up
7004	End
7005	Pg Dn
7006	Pause
7007	Scroll Lock
7008	Backspace
7009	Tab
7010	Print Screen
7011	Insert
7012	Home
7013	Enter
7014	Escape

Table 39 Extended Key Character Set (Continued)

Extended Keypad	Keystroke
7015	Up Arrow
7016	Dn Arrow
7017	Left Arrow
7018	Right Arrow

Programming Reference

Symbol Code Identifiers

Table 40 Symbol Code Characters

Code Character	Code Type
A	UPC-A, UPC-E, UPC-E1, EAN-8, EAN-13
B	Code 39, Code 32
C	Codabar
D	Code 128, ISBT 128, ISBT 128 Concatenated
E	Code 93
F	Interleaved 2 of 5
G	Discrete 2 of 5, or Discrete 2 of 5 IATA
H	Code 11
J	MSI
K	GS1-128
L	Bookland EAN
M	Trioptic Code 39
N	Coupon Code
R	GS1 DataBar Family
S	Matrix 2 of 5
T	UCC Composite, TLC 39
U	Chinese 2 of 5
V	Korean 3 of 5
X	ISSN EAN, PDF417, Macro PDF417, Micro PDF417
z	Aztec, Aztec Rune
P00	Data Matrix

Table 40 Symbol Code Characters (Continued)

Code Character	Code Type
P01	QR Code, MicroQR
P02	Maxicode
P03	US Postnet
P04	US Planet
P05	Japan Postal
P06	UK Postal
P08	Netherlands KIX Code
P09	Australia Post
P0A	USPS 4CB/One Code/Intelligent Mail
P0B	UPU FICS Postal
P0C	Mailmark
P0D	Grid Matrix, Grid Matrix Inverse, Grid Matrix Mirror
P0G	GS1 Data Matrix
P0H	Han Xin
P0Q	GS1 QR
P0X	Signature Capture

AIM Code Identifiers

Each AIM Code Identifier contains the three-character string **Jcm** where:

- J = Flag Character (ASCII 93)
- c = Code Character (see [Table 41](#))
- m = Modifier Character (see [Table 42](#))

Table 41 Aim Code Characters

Code Character	Code Type
A	Code 39, Code 39 Full ASCII, Code 32
C	Code 128, ISBT 128, ISBT 128 Concatenated, GS1-128, Coupon (Code 128 portion)
d	Data Matrix, GS1 Data Matrix
E	UPC/EAN, Coupon (UPC portion)
e	GS1 DataBar Family
F	Codabar

Table 41 Aim Code Characters (Continued)

Code Character	Code Type
G	Code 93
H	Code 11
h	Han Xin
I	Interleaved 2 of 5
L	PDF417, Macro PDF417, Micro PDF417
L2	TLC 39
M	MSI
Q	QR Code, MicroQR, GS1 QR
S	Discrete 2 of 5, IATA 2 of 5
U	Maxicode
z	Aztec, Aztec Rune
X	Bookland EAN, ISSN EAN, Trioptic Code 39, Chinese 2 of 5, Matrix 2 of 5, Korean 3 of 5, US Postnet, US Planet, UK Postal, Japan Postal, Australia Post, Netherlands KIX Code, USPS 4CB/One Code/ Intelligent Mail, UPU FICS Postal, Mailmark, Signature Capture
]g	Grid Matrix, Grid Matrix Inverse, Grid Matrix Mirror

The modifier character is the sum of the applicable option values based on [Table 42](#).

Table 42 Modifier Characters

Code Type	Option Value	Option
Code 39	0	No check character or Full ASCII processing.
	1	Reader has checked one check character.
	3	Reader has checked and stripped check character.
	4	Reader has performed Full ASCII character conversion.
	5	Reader has performed Full ASCII character conversion and checked one check character.
	7	Reader has performed Full ASCII character conversion and checked and stripped check character.
	Example: A Full ASCII barcode with check character W, A+I+MI+DW , is transmitted as JA7AIMID where $7 = (3+4)$.	
Trioptic Code 39	0	No option specified at this time. Always transmit 0.
	Example: A Trioptic barcode 412356 is transmitted as JX0412356	

Table 42 Modifier Characters (Continued)

Code Type	Option Value	Option
Code 128	0	Standard data packet, no Function code 1 in first symbol position.
	1	Function code 1 in first symbol character position.
	2	Function code 1 in second symbol character position.
	Example: A Code (EAN) 128 barcode with Function 1 character ^{FNC1} in the first position, AIMID is transmitted as JC1 AIMID	
I 2 of 5	0	No check digit processing.
	1	Reader has validated check digit.
	3	Reader has validated and stripped check digit.
	Example: An I 2 of 5 barcode without check digit, 4123, is transmitted as J10 4123	
Codabar	0	No check digit processing.
	1	Reader has checked check digit.
	3	Reader has stripped check digit before transmission.
	Example: A Codabar barcode without check digit, 4123, is transmitted as JF0 4123	
Code 93	0	No options specified at this time. Always transmit 0.
	Example: A Code 93 barcode 012345678905 is transmitted as JG00 12345678905	
MSI	0	Check digits are sent.
	1	No check digit is sent.
	Example: An MSI barcode 4123, with a single check digit checked, is transmitted as JM1 4123	
D 2 of 5	0	No options specified at this time. Always transmit 0.
	Example: A D 2 of 5 barcode 4123, is transmitted as JS0 4123	
UPC/EAN	0	Standard data packet in full EAN format, i.e., 13 digits for UPC-A, UPC-E, and EAN-13 (not including supplemental data).
	1	Two digit supplemental data only.
	2	Five digit supplemental data only.
	3	Combined data packet comprising 13 digits from EAN-13, UPC-A or UPC-E symbol and 2 or 5 digits from supplemental symbol.
	4	EAN-8 data packet.
	Example: A UPC-A barcode 012345678905 is transmitted as JE000 12345678905	
Bookland EAN	0	No options specified at this time. Always transmit 0.
	Example: A Bookland EAN barcode 123456789X is transmitted as JX0 123456789X	
ISSN EAN	0	No options specified at this time. Always transmit 0.
	Example: An ISSN EAN barcode 123456789X is transmitted as JX0 123456789X	

Table 42 Modifier Characters (Continued)

Code Type	Option Value	Option
Code 11	0	Single check digit
	1	Two check digits
	3	Check characters validated but not transmitted.
GS1 DataBar Family		No option specified at this time. Always transmit 0. GS1 DataBar Omnidirectional and GS1 DataBar Limited transmit with an Application Identifier "01". Note: In GS1-128 emulation mode, GS1 DataBar is transmitted using Code 128 rules (i.e.,]C1).
		Example: A GS1 DataBar Omnidirectional barcode 0110012345678902 is transmitted as]e00110012345678902.
EAN.UCC Composites (GS1 DataBar, GS1-128, 2D portion of UPC composite)		Native mode transmission. Note: UPC portion of composite is transmitted using UPC rules.
	0	Standard data packet.
	1	Data packet containing the data following an encoded symbol separator character.
	2	Data packet containing the data following an escape mechanism character. The data packet does not support the ECI protocol.
	3	Data packet containing the data following an escape mechanism character. The data packet supports the ECI protocol.
		GS1-128 emulation Note: UPC portion of composite is transmitted using UPC rules.
	1	Data packet is a GS1-128 symbol (i.e., data is preceded with]JC1).
PDF417, Micro PDF417	0	Reader set to conform to protocol defined in 1994 PDF417 symbology specifications. Note: When this option is transmitted, the receiver cannot reliably determine whether ECIs have been invoked or whether data byte 92 _{DEC} has been doubled in transmission.
	1	Reader set to follow the ECI protocol (Extended Channel Interpretation). All data characters 92 _{DEC} are doubled.
	2	Reader set for Basic Channel operation (no escape character transmission protocol). Data characters 92 _{DEC} are not doubled. Note: When decoders are set to this mode, unbuffered Macro symbols and symbols requiring the decoder to convey ECI escape sequences cannot be transmitted.
	3	The barcode contains a GS1-128 symbol, and the first codeword is 903-907, 912, 914, 915.
	4	The barcode contains a GS1-128 symbol, and the first codeword is in the range 908-909.
	5	The barcode contains a GS1-128 symbol, and the first codeword is in the range 910-911.
		Example: A PDF417 barcode ABCD, with no transmission protocol enabled, is transmitted as]L2ABCD.

Table 42 Modifier Characters (Continued)

Code Type	Option Value	Option
Data Matrix	0	ECC 000-140, not supported.
	1	ECC 200.
	2	ECC 200, FNC1 in first or fifth position.
	3	ECC 200, FNC1 in second or sixth position.
	4	ECC 200, ECI protocol implemented.
	5	ECC 200, FNC1 in first or fifth position, ECI protocol implemented.
	6	ECC 200, FNC1 in second or sixth position, ECI protocol implemented.
GS1 Data Matrix	2	ECC 200, FNC1 in first or fifth position.
MaxiCode	0	Symbol in Mode 4 or 5.
	1	Symbol in Mode 2 or 3.
	2	Symbol in Mode 4 or 5, ECI protocol implemented.
	3	Symbol in Mode 2 or 3, ECI protocol implemented in secondary message.
QR Code	0	Model 1 symbol.
	1	Model 2 / MicroQR symbol, ECI protocol not implemented.
	2	Model 2 symbol, ECI protocol implemented.
	3	Model 2 symbol, ECI protocol not implemented, FNC1 implied in first position.
	4	Model 2 symbol, ECI protocol implemented, FNC1 implied in first position.
	5	Model 2 symbol, ECI protocol not implemented, FNC1 implied in second position.
	6	Model 2 symbol, ECI protocol implemented, FNC1 implied in second position.
GS1 QR	3	Model 2 symbol, ECI protocol not implemented, FNC1 implied in first position.
Aztec	0	Aztec symbol.
	C	Aztec Rune symbol.
Han Xin	0	Generic data, no special features are set. The transmitted data does not follow the AIM ECI protocol.
	1	ECI protocol enabled. There is at least one ECI mode encoded. Transmitted data must follow the AIM ECI protocol.

Table 42 Modifier Characters (Continued)

Code Type	Option Value	Option
Grid Matrix, Grid Matrix Inverse, Grid Matrix Mirror	0	No options specified at this time. Always transmit 0.
Mailmark	0	No option specified at this time. Always transmit 0.

Communication Protocol Functionality

Functionality Supported via Communication (Cable) Interface

Table 43 lists supported scanner functionality by communication protocol.

Table 43 Communication Interface Functionality

Communication Interfaces	Functionality		
	Data Transmission	Remote Management	Image and Video Transmission
USB			
HID Keyboard Emulation	Supported	Not Available	Not Available
CDC COM Port Emulation	Supported	Not Available	Not Available
SSI over CDC COM Port Emulation	Supported	Supported	Supported
IBM Table-top USB	Supported	Supported	Not Available
IBM Hand-held USB	Supported	Supported	Not Available
USB OPOS Hand-held	Supported	Supported	Not Available
Symbol Native API (SNAPI) without Imaging Interface	Supported	Supported	Not Available
Symbol Native API (SNAPI) with Imaging Interface	Supported	Supported	Supported
RS-232			
Standard RS-232	Supported	Not Available	Not Available
ICL RS-232	Supported	Not Available	Not Available
Fujitsu RS-232	Supported	Not Available	Not Available
Wincor-Nixdorf RS-232 Mode A	Supported	Not Available	Not Available
Wincor-Nixdorf RS-232 Mode B	Supported	Not Available	Not Available
Olivetti ORS4500	Supported	Not Available	Not Available
Omron	Supported	Not Available	Not Available

Table 43 Communication Interface Functionality (Continued)

Communication Interfaces	Functionality		
	Data Transmission	Remote Management	Image and Video Transmission
CUTE	Supported	Not Available	Not Available
OPOS/JPOS	Supported	Not Available	Not Available
SSI	Supported	Supported	Supported
IBM 4690			
Hand-held Scanner Emulation (Port 9B)	Supported	Not Available	Not Available
Table-top Scanner Emulation (Port 17)	Supported	Supported	Not Available
Non-IBM Scanner Emulation (Port 5B)	Supported	Supported	Not Available
Keyboard Wedge			
IBM PC/AT & IBM PC Compatibles	Supported	Not Available	Not Available
IBM AT Notebook	Supported	Not Available	Not Available

Country Codes

Introduction

This chapter provides instructions for programming the keyboard to interface with a USB or Keyboard Wedge host. The host powers the scanner. For host setup information, see [USB Interface](#) and [Keyboard Wedge Interface](#).

To select a code page for the country keyboard type, see [Country Code Pages](#).

Throughout the programming barcode menus, default values are indicated with asterisks (*).

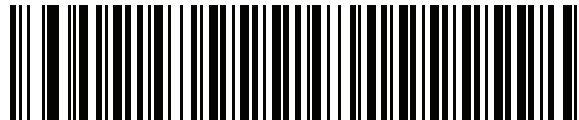

*Indicates Default — *US English (North American) — Feature/Option

USB and Keyboard Wedge Country Keyboard Types (Country Codes)

Scan the barcode corresponding to the keyboard type. For a USB host, this setting applies only to the USB Keyboard (HID) device. If the keyboard type is not listed, see [Keypad Emulation on page 246](#) for the USB HID host. For a keyboard wedge host, see [Alternate Numeric Keypad Emulation on page 311](#).



NOTE: When changing USB country keyboard types the scanner automatically resets and issues the standard startup beep sequences.



NOTE: For best results when using international keyboards, enable [Quick Keypad Emulation on page 246](#).



IMPORTANT:

- Some country keyboard barcode types are specific to certain Windows operating systems (that is, XP and Windows 7 or higher). Barcodes requiring a specific Windows OS are noted in the barcode captions.
- Use the **French International** barcode for Belgian French keyboards.

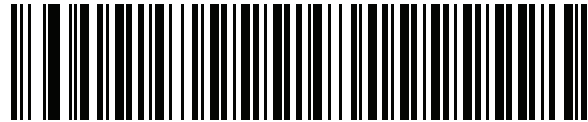

* US English (North American)



US English (Mac)



Albanian



Arabic (101)

Country Codes (Continued)

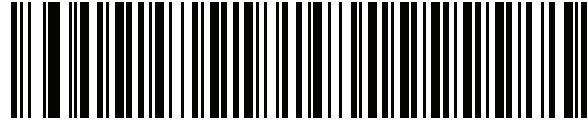

Arabic (102)

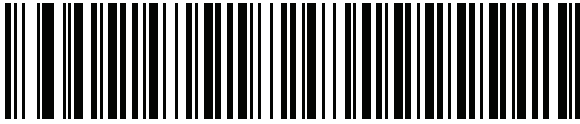

Arabic (102) AZERTY

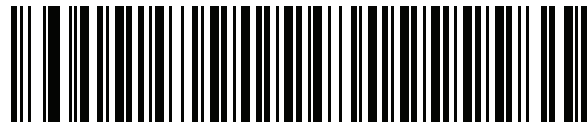

Azeri (Latin)

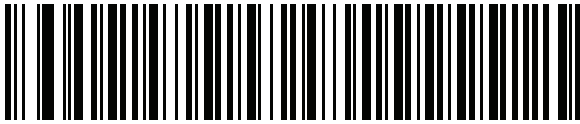

Azeri (Cyrillic)

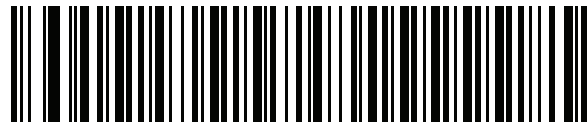

Belarusian



Bosnian (Latin)



Bosnian (Cyrillic)

Country Codes (Continued)



Bulgarian (Latin)

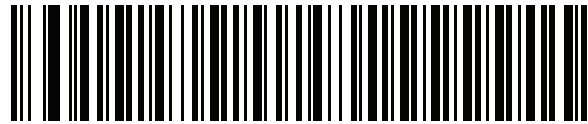

**Bulgarian Cyrillic (Typewriter)
(Bulgarian -Windows XP
Typewriter - Windows 7 or higher)**



Canadian French Win7

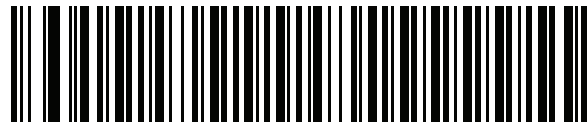

Canadian French (Legacy)

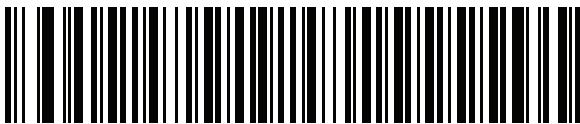

Canadian Multilingual Standard



Chinese (ASCII)

Country Codes (Continued)



Chinese (Simplified)*

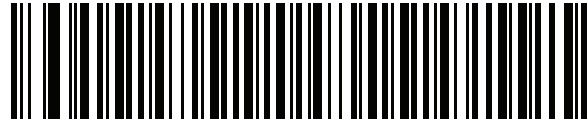

Chinese (Traditional)*

*For CJK keyboard types, see [CJK Decode Control](#).

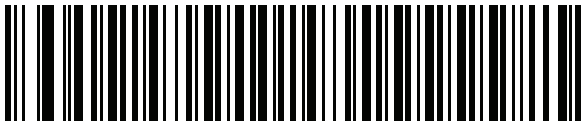

Croatian

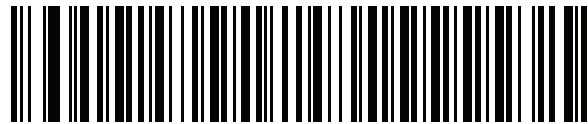

Czech



Czech (Programmer)



Czech (QWERTY)



Danish

Country Codes (Continued)



Dutch (Netherlands)

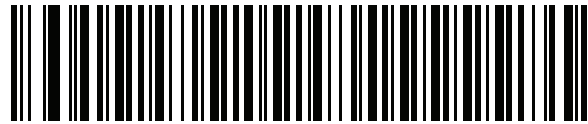

Estonian

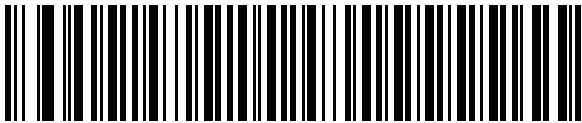

Faeroese

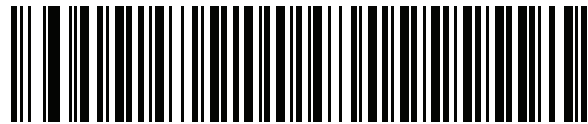

Finnish



French (France)



**French International
(Belgian French)**



French (Canada) 95/98

Country Codes (Continued)



French (Canada) 2000/XP*

*There is also a country code barcode for [Canadian Multilingual Standard on page 483](#). Be sure to select the appropriate barcode for your host system.

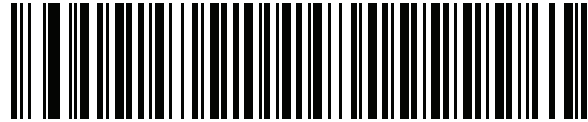

Galician

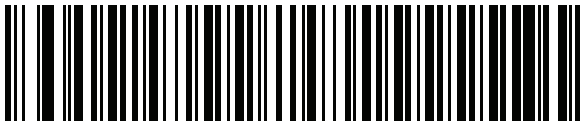

German

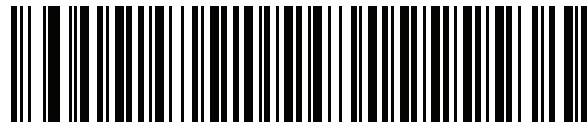

Greek Latin



Greek (220) Latin



Greek (319) Latin



Greek

Country Codes (Continued)

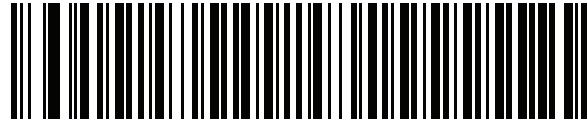

Greek (220)

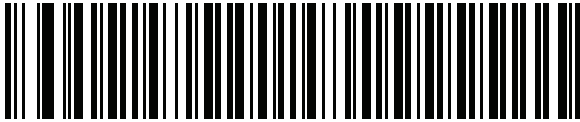

Greek (319)

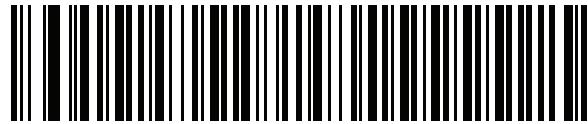

Greek Polytonic

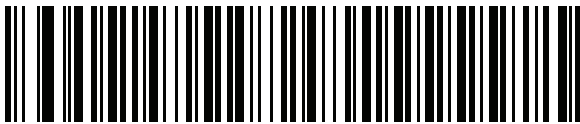

Hebrew Israel

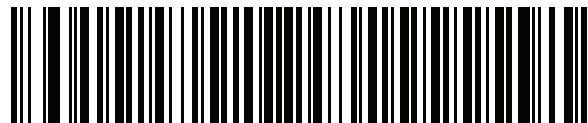

Hungarian



Hungarian_101KEY



Icelandic

Country Codes (Continued)

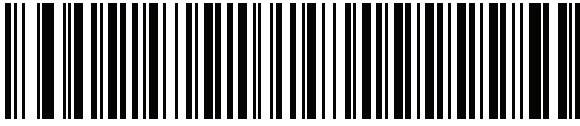

Irish

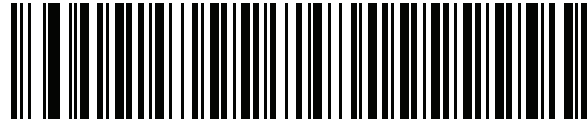

Italian

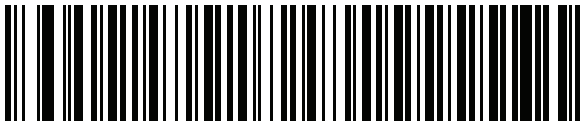

Italian (142)

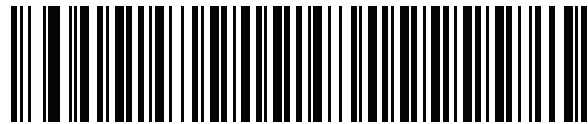

Japanese (ASCII)



Japanese (SHIFT-JIS)*

*For CJK keyboard types, see [CJK Decode Control](#).



Kazakh



Korean (ASCII)

Country Codes (Continued)



Korean (Hangul)*

*For CJK keyboard types, see [CJK Decode Control](#).

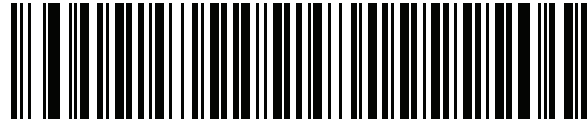

Kyrgyz

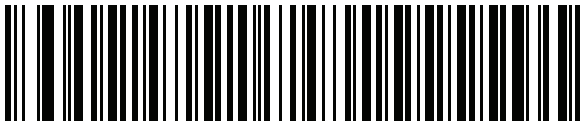

Latin American

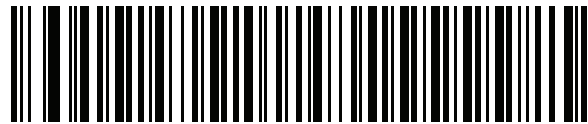

Latvian



Latvian (QWERTY)



Lithuanian



Lithuanian (IBM)

Country Codes (Continued)

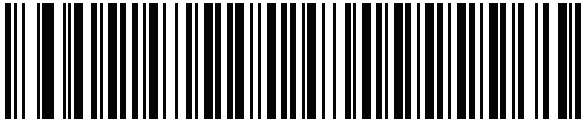

Macedonian (FYROM)

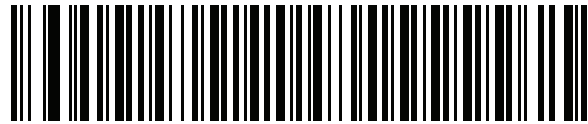

Maltese_47KEY

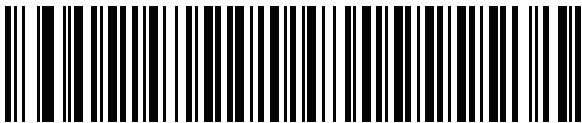

Mongolian

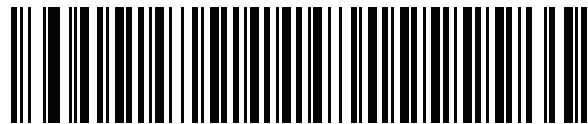

Norwegian

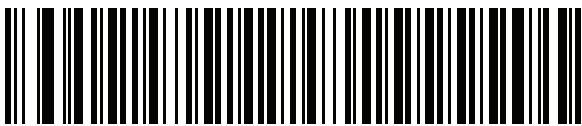

Polish (214)



Polish (Programmer)



**Portuguese (Brazil)
(Windows XP)**

Country Codes (Continued)

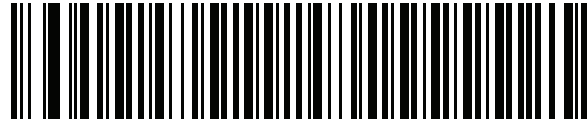

Portuguese (Brazilian ABNT)

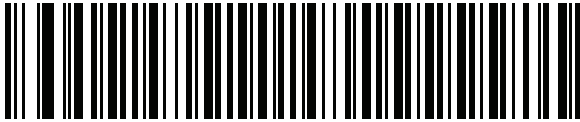

Portuguese (Brazilian ABNT2)

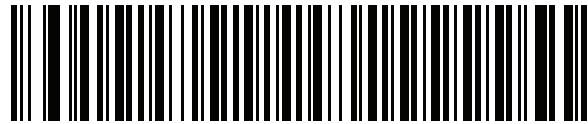

Portuguese (Portugal)

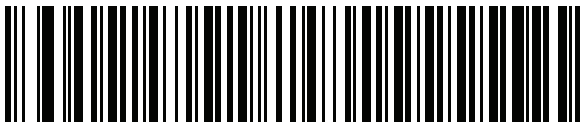

**Romanian
(Windows XP)**

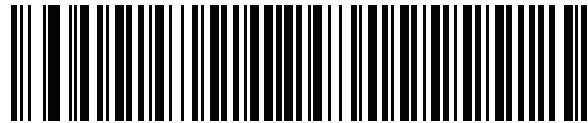

**Romanian (Legacy)
(Windows 7 or higher)**

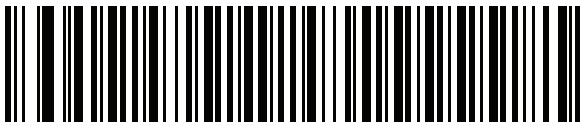

**Romanian (Standard)
(Windows 7 or higher)**

Country Codes (Continued)

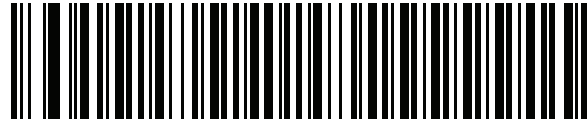

**Romanian (Programmer)
(Windows 7 or higher)**

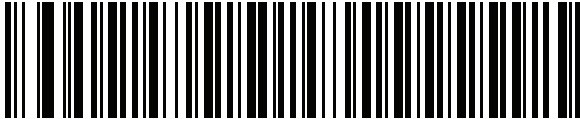

Russian

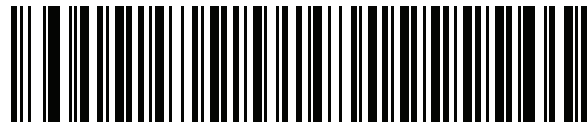

Russian (Typewriter)

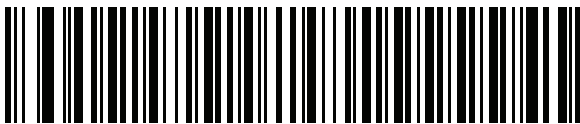

Serbian (Latin)



Serbian (Cyrillic)

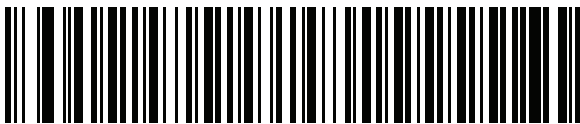

Slovak

Country Codes (Continued)



Slovak (QWERTY)

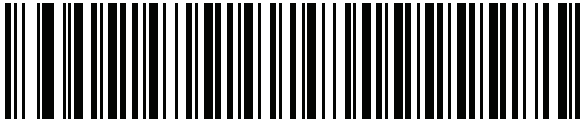

Slovenian

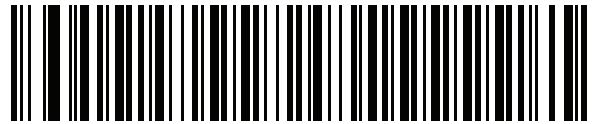

Spanish

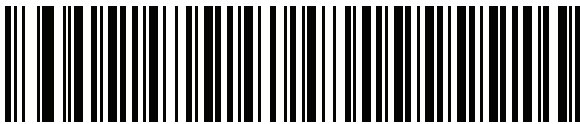

Spanish (Variation)



Swedish



Swiss French



Swiss German

Country Codes (Continued)

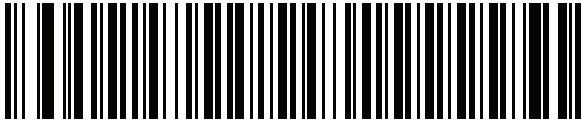

Tatar

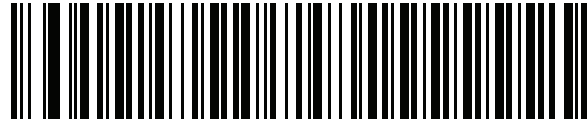

Thai (Kedmanee)

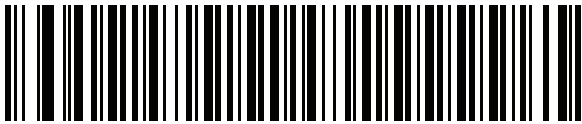

Turkish F

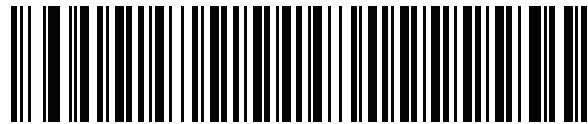

Turkish Q



UK English



Ukrainian



US Dvorak

Country Codes (Continued)

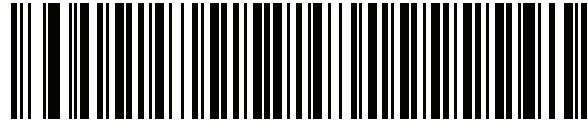

US Dvorak Left

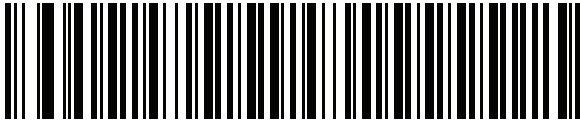

US Dvorak Right

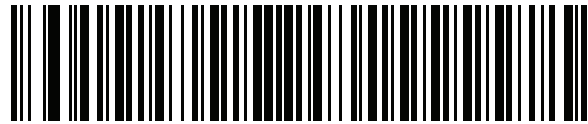

US International

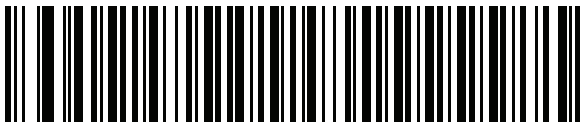

Uzbek



Vietnamese

Country Code Pages

Introduction

This chapter provides barcodes for selecting code pages for the country keyboard type selected in [Country Codes](#). If the default code page in [Table 44](#) is appropriate for your selected country keyboard type, you do not need to scan a country code page barcode.



NOTE: ADF rules can also specify a code page based on the symbology and other ADF criteria. Refer to the Advanced Data Formatting Programmer Guide.

Country Code Page Defaults

[Table 44](#) lists the code page default for each country keyboard.

Table 44 Country Code Page Defaults

Country Keyboard	Code Page Default
US English (North American)	Windows 1252
US English (Mac)	Mac CP10000
Albanian	Windows 1250
Arabic 101	Windows 1256
Arabic 102	Windows 1256
Arabic 102 AZERTY	Windows 1256
Azeri Latin	Windows 1254
Azeri Cyrillic	Windows 1251
Belarusian	Windows 1251
Bosnian Latin	Windows 1250
Bosnian Cyrillic	Windows 1251
Bulgarian Latin	Windows 1250
Bulgarian Cyrillic	Windows 1251

Table 44 Country Code Page Defaults (Continued)

Country Keyboard	Code Page Default
Canadian French Win7	Windows 1252
Canadian French (Legacy)	Windows 1252
Canadian Multilingual	Windows 1252
Croatian	Windows 1250
Chinese ASCII	Windows 1252
Chinese (Simplified)	Windows 936, GBK
Chinese (Traditional)	Windows 950, Big5
Czech	Windows 1250
Czech Programmers	Windows 1250
Czech QWERTY	Windows 1250
Danish	Windows 1252
Dutch Netherland	Windows 1252
Estonian	Windows 1257
Faeroese	Windows 1252
Finnish	Windows 1252
French (France)	Windows 1252
French (Canada) 95/98	Windows 1252
French (Canada) 2000/XP	Windows 1252
French International (Belgian French)	Windows 1252
Galician	Windows 1252
German	Windows 1252
Greek Latin	Windows 1252
Greek220 Latin	Windows 1253
Greek319 Latin	Windows 1252
Greek	Windows 1253
Greek220	Windows 1253
Greek319	Windows 1253
Greek Polytonic	Windows 1253
Hebrew Israel	Windows 1255
Hungarian	Windows 1250
Hungarian_101KEY	Windows 1250

Table 44 Country Code Page Defaults (Continued)

Country Keyboard	Code Page Default
Icelandic	Windows 1252
Irish	Windows 1252
Italian	Windows 1252
Italian_142	Windows 1252
Japanese ASCII	Windows 1252
Japanese (Shift-JIS)	Windows 932, Shift-JIS
Kazakh	Windows 1251
Korean ASCII	Windows 1252
Korean (Hangul)	Windows 949, Hangul
Kyrgyz Cyrillic	Windows 1251
Latin America	Windows 1252
Latvian	Windows 1257
Latvian QWERTY	Windows 1257
Lithuanian	Windows 1257
Lithuanian_IBM	Windows 1257
Macedonian -FYROM	Windows 1251
Maltese_47KEY	Windows 1252
Mongolian-Cyrillic	Windows 1251
Norwegian	Windows 1252
Polish_214	Windows 1250
Polish Programmer	Windows 1250
Portuguese Brazil	Windows 1252
Portuguese Brazilian ABNT	Windows 1252
Portuguese Brazilian ABNT2	Windows 1252
Portuguese Portugal	Windows 1252
Romanian	Windows 1250
Romanian Legacy	Windows 1250
Romanian Standard	Windows 1250
Romanian Programmer	Windows 1250
Russian	Windows 1251
Russian Typewriter	Windows 1251

Table 44 Country Code Page Defaults (Continued)

Country Keyboard	Code Page Default
Serbian Latin	Windows 1250
Serbian Cyrillic	Windows 1251
Slovak	Windows 1250
Slovak QWERTY	Windows 1250
Slovenian	Windows 1250
Spanish	Windows 1252
Spanish Variation	Windows 1252
Swedish	Windows 1252
Swiss French	Windows 1252
Swiss German	Windows 1252
Tatar	Windows 1251
Thai-Kedmanee	Windows 874
Turkish F	Windows 1254
Turkish Q	Windows 1254
Ukrainian	Windows 1251
United Kingdom	Windows 1252
United States	Windows 1252
US Dvorak	Windows 1252
US Dvorak Left Hand	Windows 1252
US Dvorak Right Hand	Windows 1252
US International	Windows 1252
Uzbek Cyrillic	Windows 1251
Vietnamese	Windows 1258

Country Code Page Barcodes

Scan the barcode corresponding to the country keyboard code page.



Windows 1250
Latin 2, Central European

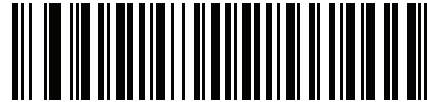

Windows 1251
Cyrillic, Slavic

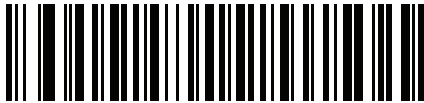

Windows 1252
Latin 1, Western European

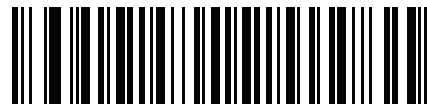

Windows 1253
Greek

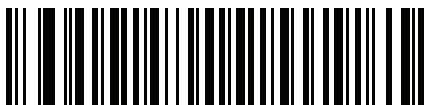

Windows 1254
Latin 5, Turkish

Country Code Pages (Continued)



**Windows 1255
Hebrew**

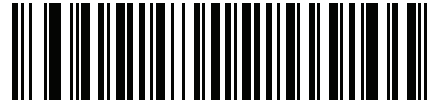

**Windows 1256
Arabic**

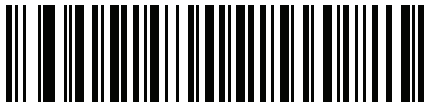

**Windows 1257
Baltic**

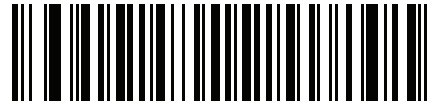

**Windows 1258
Vietnamese**

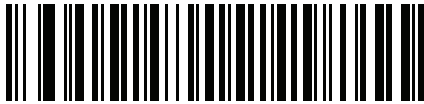

**Windows 874
Thai**

Country Code Pages (Continued)



**Windows 20866
Cyrillic KOI8-R**

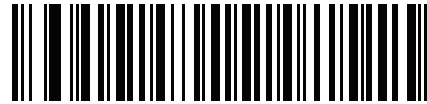

**Windows 932
Japanese Shift-JIS**

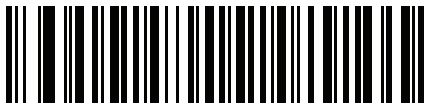

**Windows 936
Simplified Chinese GBK**

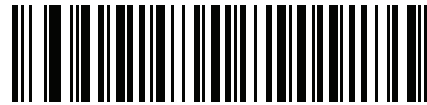

**Windows 54936
Simplified Chinese GB18030**

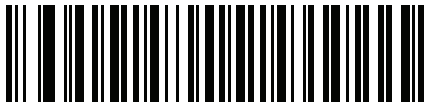

**Windows 949
Korean Hangul**

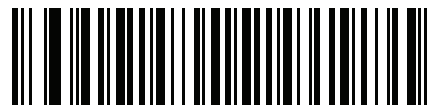

**Windows 950
Traditional Chinese Big5**

Country Code Pages (Continued)



**MS-DOS 437
Latin US**

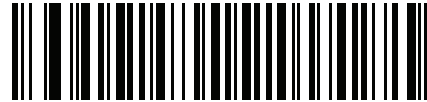

**MS-DOS 737
Greek**

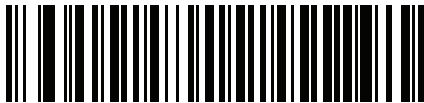

**MS-DOS 775
Baltic**

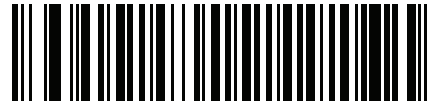

**MS-DOS 850
Latin 1**



**MS-DOS 852
Latin 2**

Country Code Pages (Continued)



**MS-DOS 855
Cyrillic**

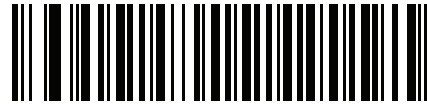

**MS-DOS 857
Turkish**

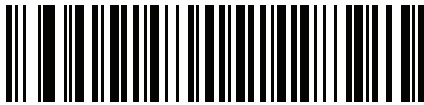

**MS-DOS 860
Portuguese**

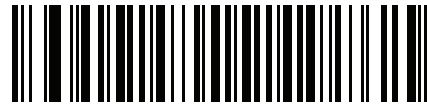

**MS-DOS 861
Icelandic**

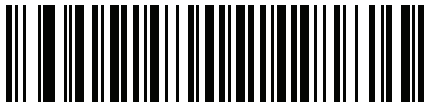

**MS-DOS 862
Hebrew**

Country Code Pages (Continued)



**MS-DOS 863
French Canada**

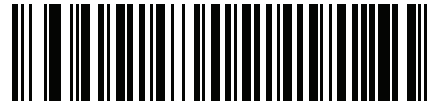

**MS-DOS 865
Nordic**

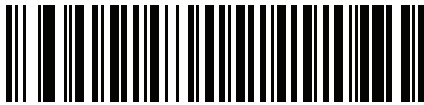

**MS-DOS 866
Cyrillic**

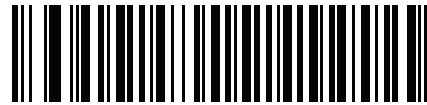

**MS-DOS 869
Greek 2**

Country Code Pages (Continued)



ISO 8859-1
Latin 1, Western European

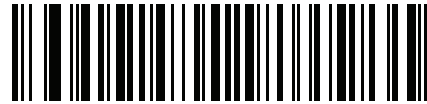

ISO 8859-2
Latin 2, Central European



ISO 8859-3
Latin 3, South European

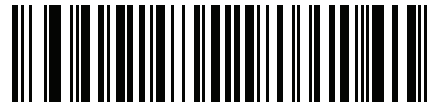

ISO 8859-4
Latin 4, North European

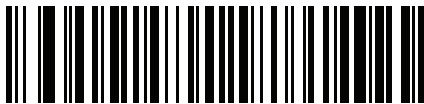

ISO 8859-5
Cyrillic

Country Code Pages (Continued)



ISO 8859-6
Arabic

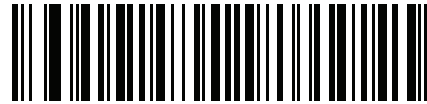

ISO 8859-7
Greek



ISO 8859-8
Hebrew

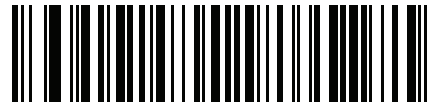

ISO 8859-9
Latin 5, Turkish

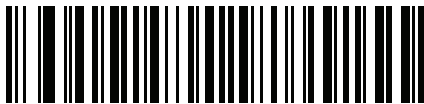

ISO 8859-10
Latin 6, Nordic

Country Code Pages (Continued)



**ISO 8859-11
Thai**

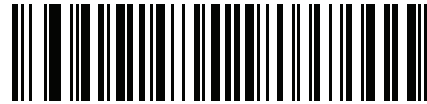

**ISO 8859-13
Latin 7, Baltic**



**ISO 8859-14
Latin 8, Celtic**

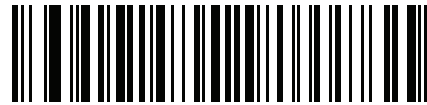

**ISO 8859-15
Latin 9**



**ISO 8859-16
Latin 10, South-Eastern European**

Country Code Pages (Continued)



UTF-8

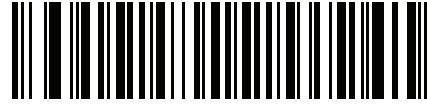

UTF-16LE
UTF-16 Little Endian

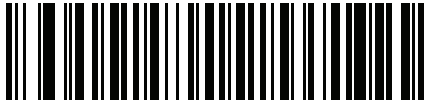

UTF-16BE
UTF-16 Big Endian

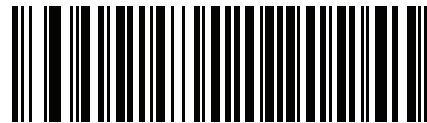

Mac CP1000
Roman

CJK Decode Control

Introduction

This chapter describes control parameters for CJK (Chinese, Japanese, Korean) barcode decode through USB HID Keyboard Emulation mode.



NOTE: Because ADF does not support CJK character processing, there is no format manipulation for CJK output.

CJK Control Parameters

Unicode Output Control

Parameter # 973

For a Unicode encoded CJK barcode, select one of the following options for unicode output:

- **Universal Output to Unicode and MBCS Application** - This default method applies to Unicode and MBCS expected applications, such as MS Word and Notepad on a Windows host.



NOTE: To support Unicode universal output, set up the registry table for the Windows host. See [Unicode/CJK Decode Setup with Windows Host on page 514](#).

- **Output to Unicode Application Only** - This method applies only to Unicode expected applications, such as MS Word and WordPad, but not Notepad.



* Universal Output
(0)



Unicode Application Only
(1)

CJK Output Method to Windows Host

Parameter # 972

For a national standard encoded CJK barcode, select one of the following options for CJK output to a Windows host:

- **Universal CJK Output** - This is the default universal CJK output method for US English IME or Chinese/Japanese/Korean ASCII IME on a Windows host. This method converts CJK characters to Unicode and emulates the characters when transmitting to the host. Use the [Unicode Output Control](#) parameter to control Unicode output.
-  **NOTE:** To support universal CJK output, set up the registry table for the Windows host. See [Unicode/CJK Decode Setup with Windows Host on page 514](#).
- **Other options for CJK output** - With the following methods, the scanner sends the CJK character hexadecimal internal code (Nei Ma) value to the host, or converts the CJK character to Unicode and sends the hexadecimal Unicode value to the host. When using these methods, the Windows host must select the corresponding IME to accept the CJK character. See [Unicode/CJK Decode Setup with Windows Host on page 514](#).
 - **Japanese Unicode Output**
 - **Simplified Chinese GBK Code Output**
 - **Simplified Chinese Unicode Output**
 - **Korean Unicode Code Output**
 - **Traditional Chinese Big5 Code Output** (Windows XP)
 - **Traditional Chinese Big5 Code Output** (Windows 7)
 - **Traditional Chinese Unicode Code Output** (Windows XP)
 - **Traditional Chinese Unicode Code Output** (Windows 7)



NOTE: The Unicode emulate output method depends on the host system (Windows XP or Windows 7).

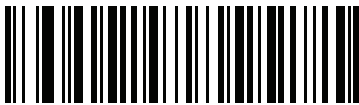

* Universal CJK Output
(0)



Japanese Unicode Output
(34)

(For Japanese Unicode Output, select Simplified Chinese Unicode IME on the Windows host)

CJK Output Method to Windows Host (continued)



**Chinese (Simplified) GBK Output
(1)**



**Chinese (Simplified) Unicode Output
(2)**

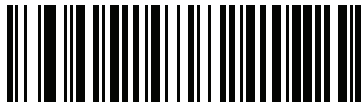

**Korean Unicode Output
(50)**

(for Korean Unicode Output, select Simplified Chinese Unicode IME on the Windows host)

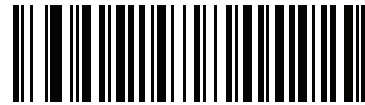

**Chinese (Traditional) Big5 Output (Windows XP)
(17)**



**Chinese (Traditional) Big5 Output (Windows 7)
(19)**



**Chinese (Traditional) Unicode Output (Windows XP)
(18)**



**Chinese (Traditional) Unicode Output (Windows 7)
(20)**

Non-CJK UTF Barcode Output

Parameter # 960

Some country keyboard type layouts contain characters that do not exist in the default code page (see [Country Keyboard Type Missing Characters on page 513](#)). Although the default code page can not encode these characters in a barcode, they can be encoded in the UTF-8 barcode. Scan the following barcode to output the Unicode values by emulation mode.



NOTE: Use this special country keyboard type to decode the non-CJK UTF-8 barcode. After decoding, re-configure the scanner to use the original country keyboard type.

Use US English IME on Windows. See [Unicode Output Control on page 510](#).



Non-CJK UTF-8 Emulation Output

Country Keyboard Type Missing Characters

Country keyboard type: **Tatar, Uzbek, Mongolian, Kyrgyz, Kazakh and Azeri**

Default code page: CP1251

Table 45 Missing Characters

ƒ	F
х	Ҥ
к	Қ
h	Һ
ө	Ө
ә	Ә
Ү	У
н	Ң
ж	Ж
Ғ	
н	Ң
Ү	У
к	Қ

Table 45 Missing Characters (Continued)

ı	Ț
κ	Κ

Country keyboard type: **Romanian (Standard)**

Default code page: CP1250

Table 46 Missing Characters

ş	Ş
ţ	Ț

Country keyboard type: **Portuguese-Brazilian (ABNT), Portuguese-Brazilian (ABNT2)**

Default code page: CP1252

Missing character: **€**

Country keyboard type: **Azeri-Latin**

Default code page: CP1254

Missing characters: ə, Ə

Unicode/CJK Decode Setup with Windows Host

This section describes how to set up CJK decode with a Windows host.

Setting Up the Windows Registry Table for Unicode Universal Output

To support the Unicode universal output method, set up the Windows host registry table as follows:

1. Select **Start > Run > regedt32** to start the registry editor.
2. Under **HKEY_Current_User\Control Panel\Input Method**, set **EnableHexNumpad** to **1** as follows:

```
[HKEY_CURRENT_USER\Control Panel\Input Method]
```

```
"EnableHexNumpad"="1"
```

If this key does not exist, add it as type **REG_SZ** (string value).

3. Reboot the computer to implement the registry change.

Adding CJK IME on Windows

To add the desired CJK input language:

1. Click **Start > Control Panel**.

2. If the Control Panel opens in category view, select **Switch to Classic View** in the top left corner.
3. Select **Regional and Language Options**.
4. Click the **Language** tab.
5. Under **Supplemental Language Support**, select the **Install Files for East Asian Languages** check box if not already selected, and click **Apply**. This may require a Windows installation CD to install the required files. This step ensures that the East Asian Languages (CJK) are available.
6. Under **Text Services and Input Language**, click **Details**.
7. Under **Installed Services**, click **Add**.
8. In the **Add Input Language** dialog box, choose the CJK input language and keyboard layout or Input Method Editor (IME) to add.
9. Click **OK** twice. The language indicator appears in the system tray (at bottom right corner of the desktop by default). To switch between input languages (keyboard languages) select the language indicator in the system tray.
10. Select the language indicator in the system tray to select the desired country keyboard type.
11. Verify that the characters displayed on each country's keyboard appear.

Selecting the Simplified Chinese Input Method on the Host

To select the Simplified Chinese input method:

- Select Unicode/GBK input on Windows XP: **Chinese (Simplified) - NeiMa**, then click the input bar to select **Unicode** or **GBK NeiMa** input.

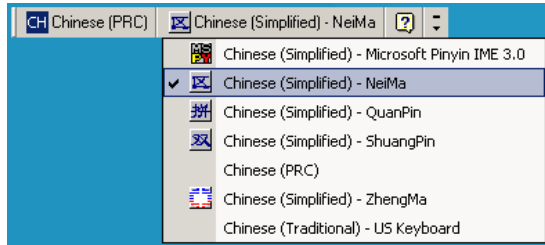

Or



- Select Unicode/GBK input on Windows 7: **Chinese (Simplified) - Microsoft Pinyin New Experience Input Style**, then select **Tool Menu > Secondary Inputs > Unicode Input** or **GB Code Input**.

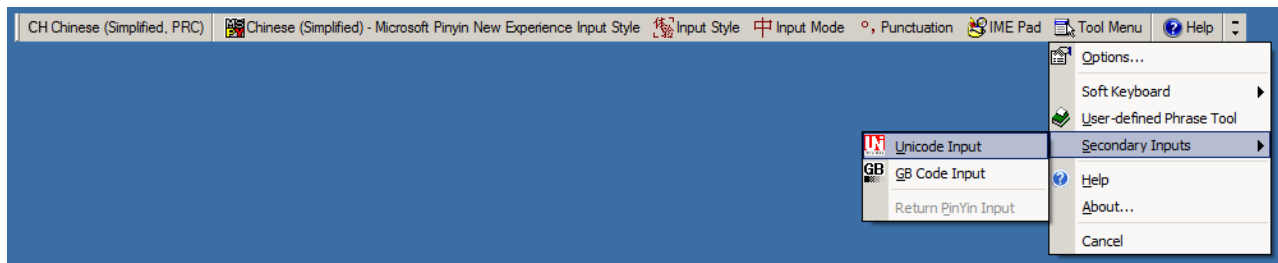

Selecting the Traditional Chinese Input Method on the Host

To select the Traditional Chinese input method:

- Select Unicode input on Windows XP: **Chinese (Traditional) - Unicode**

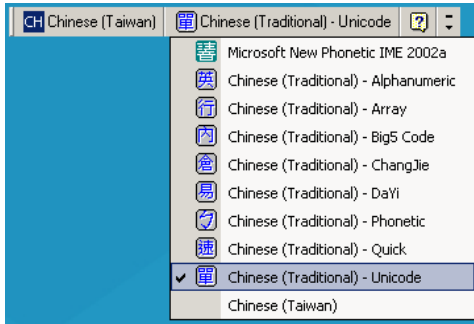

- Select Big5 input on Windows XP: **Chinese (Traditional) - Big5 Code**

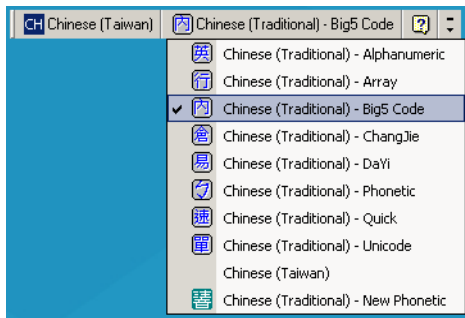

- Select Unicode/Big5 input on Windows 7: **Chinese (Traditional) - New Quick**. This option support both Unicode and Big5 input.



Signature Capture

Introduction

CapCode, a signature capture code, is a special pattern that encloses a signature area on a document and allows a scanner to capture a signature.

There are several accepted patterns that allow automatic identification of different signatures on the same form. For example, on the federal tax return 1040 form there are three signature areas, one each for two joint filers, and one for a professional preparer. By using different patterns, a program can correctly identify all three, so they can be captured in any sequence and still be identified correctly.

Code Structure

Signature Capture Area

A CapCode is printed as two identical patterns on either side of a signature capture box, as shown in [Figure 37](#). Each pattern extends the full height of the signature capture box.

The box is optional, so you can omit it, replace it with a single baseline, or print a baseline with an "X" on top of it towards the left, as is customarily done in the US to indicate a request for signature. However, if an "X" or other markings are added in the signature box area, these are captured with the signature.

Figure 37 CapCode



CapCode Pattern Structure

A CapCode pattern structure consists of a start pattern followed by a separator space, a signature capture box, a second separator space, and then a stop pattern. Assuming that X is the dimension of the thinnest element, the start and stop patterns each contains 9X total width in 4 bars and 3 spaces. A 7X quiet zone is required to the left and to the right of the CapCode pattern.

Figure 38 CapCode Structure

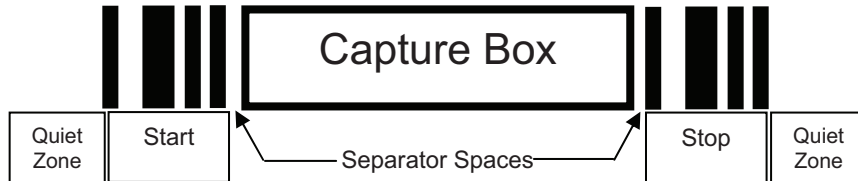

The separator spaces on either side of the signature capture box can be between 1X and 3X wide.

Start / Stop Patterns

Table 47 lists the accepted start / stop patterns. The bar and space widths are expressed as multiples of X. You must use the same pattern on either side of a signature capture box. The type value is reported with the captured signature to indicate the purpose of the signature captured.

Table 47 Start / Stop Pattern Definitions

Bar/Space Patterns							Type
B	S	B	S	B	S	B	
1	1	2	2	1	1	1	2
1	2	2	1	1	1	1	5
2	1	1	2	1	1	1	7
2	2	1	1	1	1	1	8
3	1	1	1	1	1	1	9

Table 48 lists selectable parameters used to generate the image of the captured signature.

Table 48 User Defined CapCode Parameters

Parameter	Defined
Width	Number of pixels
Height	Number of pixels
Format	JPEG, BMP, TIFF
JPEG quality	1 (most compression) to 100 (best quality)

Table 48 User Defined CapCode Parameters

Parameter	Defined
Bits Per Pixel (not applicable to JPEG format)	1 (2 levels)
	4 (16 levels)
	8 (256 levels)

BMP format does not use compression, JPEG and TIFF formats do.

Dimensions

The size of the signature capture box is determined by the height and separation of the start and stop patterns. The line width of the signature capture box is insignificant.

The thinnest element width, referred to here as X, is nominally 10 mils (1 mil = 0.0254 mm). Select this as an exact multiple of the pixel pitch of the printer used. For example, when using a 203 DPI (dots-per-inch) printer and printing 2 dots per module, the resulting X dimension is 9.85 mils.

Data Format

The decoder output is formatted according to [Table 49](#). Zebra decoders allow different user options to output or inhibit barcode type. Selecting "Symbol ID" as the barcode type for output identifies the CapCode with letter "i".

Table 49 Data Format

File Format (1 byte)	Type (1 byte)	Image Size (4 bytes, BIG Endian)	Image Data
JPEG - 1 BMP - 3 TIFF - 4	See Table 47 , last column		(Same bytes as in a data file.)

Additional Capabilities

Regardless of how the signature is captured, the output signature image is de-skewed and right-side up.

A scanner that captures signatures automatically determines whether it is scanning a signature or a barcode. You can disable the signature capturing capability in a decoder.

Signature Boxes

Figure 39 illustrates the five acceptable signature boxes.

Figure 39 Acceptable Signature Boxes

Type 2:



Type 5:



Type 7:



Type 8:



Type 9:



Non-Parameter Attributes (Attribute Data Dictionary)

Introduction

This chapter defines non-parameter attributes.

Attributes

Model Number

Attribute #533

Model number of the scanner. This electronic output matches the printout on the physical device label, for example DS9308-SR00004ZCWW.

Type	S
Size (Bytes)	18
User Mode Access	R
Values	Variable

Serial Number

Attribute #534

Unique serial number assigned in the manufacturing facility. This electronic output matches the printout on the physical device label, for example **M1J26F45V**.

Type	S
Size (Bytes)	16
User Mode Access	R
Values	Variable

Date of Manufacture

Attribute #535

Date of device manufacture assigned in the manufacturing facility. This electronic output matches the printout on the physical device label, for example **31OCT18** (which reads the 31st of October 2018).

Type	S
Size (Bytes)	7
User Mode Access	R
Values	Variable

Date of First Programming

Attribute #614

Date of first electronic programming represents the first time settings were electronically loaded to the scanner either by 123Scan or via SMS, for example **18MAY17** (which reads the 18th of May 2017).

Type	S
Size (Bytes)	7
User Mode Access	R
Values	Variable

Configuration Filename

Attribute #616

The name assigned to the configuration settings loaded electronically to the device either by 123Scan or via SMS.



NOTE: Scanning the **Set Defaults** barcode automatically changes the configuration filename to factory defaults.

To indicate the configuration settings loaded to the device were changed, the configuration filename changes to Modified upon scanning any parameter barcode.

Type	S
Size (Bytes)	17
User Mode Access	RW
Values	Variable

Beeper/LED**Attribute #6000**

Activates the beeper and/or LED.

Type	X
Size (Bytes)	N/A
User Mode Access	W

Values:

Beep / LED Action	Value
1 high short beep	0
2 high short beeps	1
3 high short beeps	2
4 high short beeps	3
5 high short beeps	4
1 low short beep	5
2 low short beeps	6
3 low short beeps	7
4 low short beeps	8
5 low short beeps	9
1 high long beep	10
2 high long beeps	11
3 high long beeps	12
4 high long beeps	13
5 high long beeps	14
1 low long beep	15
2 low long beeps	16
3 low long beeps	17
4 low long beeps	18
5 low long beeps	19
Fast warble beep	20
Slow warble beep	21
High-low beep	22
Low-high beep	23
High-low-high beep	24
Low-high-low beep	25
High-high-low-low beep	26
Green LED off	42
Green LED on	43
Red LED on	47
Red LED off	48

Parameter Defaults

Attribute #6001

This attribute restores all parameters to their factory defaults.

Type	X
Size (Bytes)	N/A
User Mode Access	W
Values	0 = Restore Defaults 1 = Restore Factory Defaults 2 = Write Custom Defaults

Parameter Buffer

Attribute #6002

Retrieves entire parameter buffer.

Type	A
Size (Bytes)	Variable
User Mode Access	R
Values	Variable

Beep on Next Bootup

Attribute #6003

This attribute configures (enables or disables) beep on next boot up of scanner.

Type	X
Size (Bytes)	N/A
User Mode Access	W
Values	0 = Disable beep on next bootup 1 = Enable beep on next bootup

Reboot

Attribute #6004

This attribute initiates a device reboot.

Type	X
Size (Bytes)	N/A
User Mode Access	W
Values	N/A

Host Trigger Session

Attribute #6005

This attribute triggers a decode session similar to manually depressing the scanner trigger button.

Type	X
Size (Bytes)	N/A
User Mode Access	W
Values	1 = Start Host Trigger Session 0 = Stop Host Trigger Session

Firmware Version

Attribute #20004

The scanner's operating system version. For example, **NBRFMAAC** or **PAAAABS00-007-R03D0**.

Type	S
Size (Bytes)	Variable
User Mode Access	R
Values	Variable

Device Class

Attribute #20007

Description of the device's hardware, for example, **Imager** or **Cordless 2D Imager**.

Type	S
Size (Bytes)	18
User Mode Access	R
Values	Variable

Scankit Version

Attribute #20008

Identifies the 1D decode algorithms resident on the device, for example **SKIT4.33T02**.

Type	S
Size (Bytes)	Variable
User Mode Access	R
Values	Variable

Combined Firmware Version

Attribute #20009

Reports firmware version of the multiple CPU's on the single product with space delimiters, for example **NBRPUAAA NBRPUDAA**.

Type	S
Size (Bytes)	Variable
User Mode Access	R
Values	Variable

RSM Version

Attribute #20011

Identifies the RSM version resident in the device, for example **2.0**.

Type	S
Size (Bytes)	3
User Mode Access	R
Values	Variable

Top Level Release Name

Attribute #20012

Returns top level combined image firmware name, for example **CAAABS00-008-R00**.

Type	S
Size (Bytes)	Variable
User Mode Access	R
Values	Variable

Imagekit Version

Attribute #20013

Identifies the 2D decode package resident in the device, for example **IMGKIT_4.04T02**.

Type	S
Size (Bytes)	Variable
User Mode Access	R
Values	Variable

DL Parser Version

Attribute #25011

Type	Type Array
Size (Bytes)	Variable
Values	Variable

DL Parser Activated

Attribute #25012

Type	Flag
Size (bytes)	1
Values	0 = Not Activated (SR Model) 1 = Activated (DL Model)

ScanSpeed Analytics



IMPORTANT: Decodes times are only reported for barcodes decoded in hand-held mode.

Identifies problematic barcodes to speed up scanning processes.

Zebra ScanSpeed Analytics software allows you to visually identify barcodes that slow down processing and impact efficiency. Over time, the software uses collected data to eliminate poor performing barcodes from inventory. For more information go to www.zebra.com/scanspeedanalytics.

ScanSpeed Analytics

Introduction



IMPORTANT: Decode times are only reported for barcodes decoded in hand-held mode.

This chapter describes the Zebra ScanSpeed Analytics software that allows the identification of barcodes that slow down processes. Over time, the collected data can be used to eliminate poor performing barcodes from inventory. When scanners capture and read data faster, processes run faster.

For more information go to www.zebra.com/scanspeedanalytics.

Histogram Decode Information

Within the scanner, each barcode symbology has a series of RSM attributes ([Table 50](#)) to access its statistic information: Decode Count; Minimum Decode Time; Slowest Decode Time; Average Decode Time; Slowest Decode Data; and, ScanSpeed Histogram.

ScanSpeed Histogram is an array of eight items of double WORD (4 bytes). Each bin holds the count of decoded barcodes per range of decode time. For example, the range of Bin1 decode times is from 0 ms to 75 ms. All the Bin time ranges are show below:

Bin1 <= 75ms

Bin2 <= 110ms

Bin3 <= 170ms

Bin4 <= 300ms

Bin5 <= 600ms

Bin6 <= 1000ms

Bin7 <= 1500ms

Bin8 > 1500ms

123Scan displays this histogram data in its **Statistics** tab shown in [Figure 40 on page 530](#).

Figure 40 123Scan Statistics Tab - Histogram Data

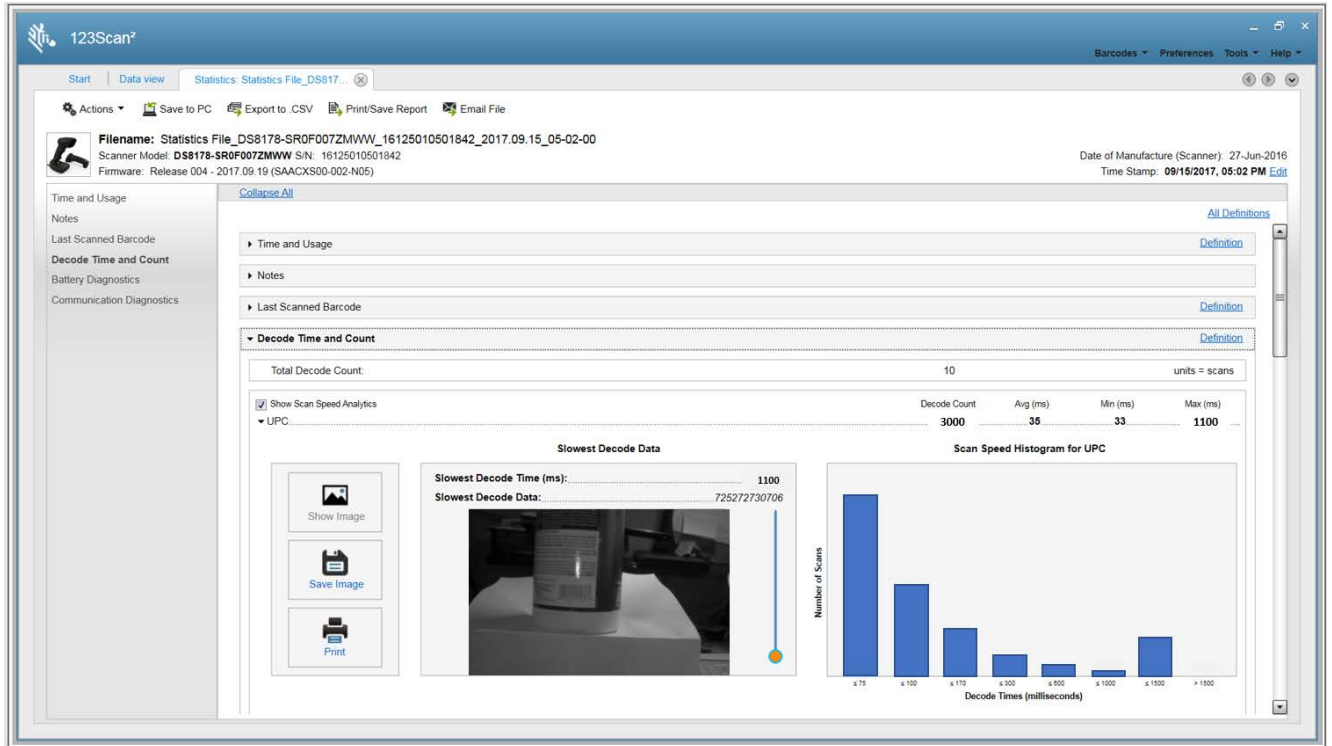

Table 50 Attributes Numbers of Barcode Symbology Statistic Information

Barcode Name	Decode Count		Minimum Decode Time	Slowest Decode Time (Max Decode Time)	Average Decode Time	Slowest Decode Data	ScanSpeed Histogram
	Decimal Value	Hex Value (Shown in Little Endian Format)					
UPC	15421	0x3D, 0x3C	15424	15425	15426	15707	15706
EAN/JAN	15428	0x44, 0x3C	15431	15432	15433	15709	15708
2 of 5	15449	0x59, 0x3C	15452	15453	15454	15715	15714
Codabar	15456	0x60, 0x3C	15459	15460	15461	15717	15716
Code 11	15477	0x75, 0x3C	15480	15481	15482	15723	15722
Code 128	15442	0x52, 0x3C	15445	15446	15447	15713	15712
Code 39	15435	0x4B, 0x3C	15438	15439	15440	15711	15710

Table 50 Attributes Numbers of Barcode Symbology Statistic Information (Continued)

Barcode Name	Decode Count		Minimum Decode Time	Slowest Decode Time (Max Decode Time)	Average Decode Time	Slowest Decode Data	ScanSpeed Histogram
	Decimal Value	Hex Value (Shown in Little Endian Format)					
Code 93	15463	0x67, 0x3C	15466	15467	15468	15719	15718
Composite	15519	0x9F, 0x3C	15522	15523	15524	15735	15734
GS1 DataBar	15512	0x98, 0x3C	15515	15516	15517	15733	15732
MSI	15470	0x6E, 0x3C	15473	15474	15475	15721	15720
Data Matrix	15491	0x83, 0x3C	15494	15495	15496	15727	15726
PDF	15484	0x7C, 0x3C	15487	15488	15489	15725	15724
Postal Codes	15505	0x91, 0x3C	15508	15509	15510	15731	15730
QR	15498	0x8A, 0x3C	15501	15502	15503	15729	15728
Aztec	15533	0xAD, 0x3C	15536	15537	15538	15739	15738
OCR	15526	0xA6, 0x3C	15529	15530	15531	15737	15736
Maxicode	15659	0x2B, 0x3D	15662	15663	15664	15755	15754
GS1-Data Matrix	15673	0x39, 0x3D	15676	15677	15678	15747	15746
GS1-QR Code	15680	0x40, 0x3D	15683	15684	15685	15749	15748
Coupon	15666	0x32, 0x3D	15669	15670	15671	15757	15756
Other 1D	15540	0xB4, 0x3C	15543	15544	15545	15741	15740
Other 2D	15547	0xBB, 0x3C	15550	15551	15552	15743	15742
Other	15554	0xC2, 0x3C	15557	15558	15559	15745	15744

Table 50 Attributes Numbers of Barcode Symbology Statistic Information (Continued)

Barcode Name	Decode Count		Minimum Decode Time	Slowest Decode Time (Max Decode Time)	Average Decode Time	Slowest Decode Data	ScanSpeed Histogram
	Decimal Value	Hex Value (Shown in Little Endian Format)					
Unused Statistic ID	19999	0x1F, 0x4E	19999	19999	19999	19999	19999

Example

The UPC data below is taken from the first row of [Table 50](#) above.

UPC DECODE COUNT

Attribute #: 15421

Type: DWORD (4 bytes)

Description: Returns the UPC barcode decode count, including all variants (UPC-A, UPC-E, UPC-E1, etc.).

UPC MINIMUM DECODE TIME

Attribute #: 15424

Type: DWORD (4 bytes)

Description: Returns the Minimum Decode Time in milliseconds of all UPC barcode decodes.

UPC SLOWEST DECODE TIME

Attribute #: 15425

Type: DWORD (4 bytes)

Description: Returns the Slowest Decode Time in milliseconds of all UPC barcode decodes.

UPC AVERAGE DECODE TIME

Attribute #: 15426

Type: DWORD (4 bytes)

Description: Returns the Average Decode Time in milliseconds of all UPC barcode decodes.

UPC SLOWEST DECODE DATA

Attribute #: 15707

Type: Array of BYTE (25 bytes)

Description: Returns the UPC barcode data with the Slowest Decode Time.

UPC SCANSPEED HISTOGRAM

Attribute #: 15706

Type: Array of DWORD (32 bytes)

Description: Returns the UPC barcode ScanSpeed Histogram.

Image of Slowest Decoded Barcode

The user can configure the scanner to store the image(s) of the slowest decoded barcode.

Table 51 RSM Attributes to Store/Retrieve Image of Slowest Decoded Barcode

Attribute #	Type	Property	Default Value	Description
1755	Array of WORD	RW	Default format = {0x1F, 0x4E} 0x1F, 0x4E No image retained Barcode name = Unused Statistic ID Decimal value = 19999 see last row in Table 50 on page 530 0x3D, 0x3C Image retained for UPC Decimal value = 15421 Sample image retained for UPC only = {0x3D, 0x3C}	Attribute 1755 is named List of Stored Images. This attribute defines which image, by symbology, of the slowest decoded barcode will be stored in the scanner. One symbology image can be stored in the scanner. Note: {0x1F, 0x4E} = a 1 WORD value which is in little-endian format.
1756	WORD	RW	0	Attribute 1756 is named Threshold To Store Slowest Decode Barcode Image. This attribute defines the threshold above which the scanner stores the image of the slowest decoded barcode. Specify a Histogram Bin value (0, 1, 2, 3, 4, 5, 6 or 7). The purpose of setting up this threshold is to reduce the barcode image storage frequency. 0 - No threshold check (default value) 1 - Specifies the decode time threshold as Histogram Bin 1 value of 75 ms Similarly, the other Histogram Bins specify the corresponding threshold time as follows: Bin 1 <= 75ms Bin 2 <= 110ms Bin 3 <= 170ms Bin 4 <= 300ms Bin 5 <= 600ms Bin 6 <= 1000ms Bin 7 <= 1500ms

Table 51 RSM Attributes to Store/Retrieve Image of Slowest Decoded Barcode (Continued)

Attribute #	Type	Property	Default Value	Description
6036	WORD	WO	N/A	<p>Attribute 6036 is named Retrieve Slowest Decoded Barcode Image.</p> <p>The image must be retrieved using the SNAPI communication protocol.</p> <p>This attribute allows you to retrieve from the scanner a single image, by symbology, of the slowest decoded data.</p> <p>For example, to retrieve the slowest decoded barcode image for a UPC symbology, enter its hex value, 0x3D, 0x3C (decimal value 15421), using a SET command.</p> <p>See Table 50 on page 530 for symbology hex and decimal values.</p>

Sample Barcodes



IMPORTANT: To read a sample barcode the parameter must be enabled. To enable a parameter scan the appropriate **Enable** barcode in [Symbologies](#).

UPC/EAN

UPC-A, 100%



UPC-A with 2-digit Add-on

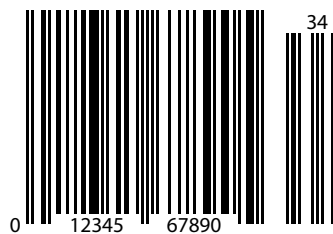

UPC-A with 5-digit Add-on



UPC-E



UPC-E with 2-digit Add-on



UPC-E with 5-digit Add-on



EAN-8

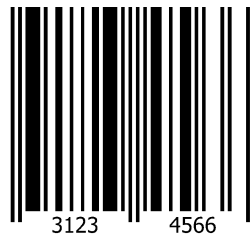

EAN-13, 100%



EAN-13 with 2-digit Add-on



EAN-13 with 5-digit Add-on



Code 128



GS1-128



Code 39



Code 93

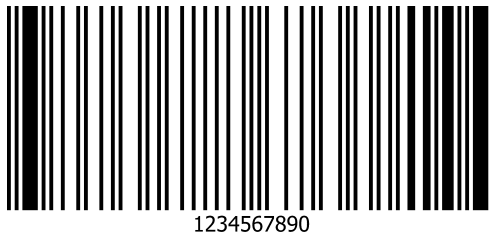

Code 11 with 2 Check Digits



Interleaved 2 of 5



MSI with 2 Check Digits



Chinese 2 of 5

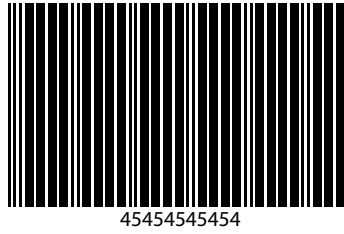

Matrix 2 of 5



Korean 3 of 5



GS1 DataBar

GS1 DataBar Omnidirectional (formerly GS1 DataBar-14)



7612341562341

GS1 DataBar Truncated

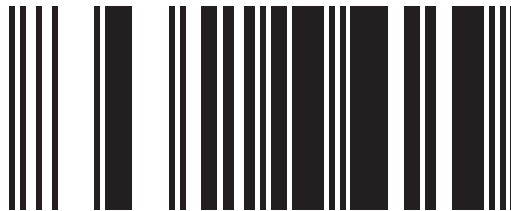

(01)00614141999996

GS1 DataBar Stacked



GS1 DataBar Stacked Omnidirectional



GS1 DataBar Limited



GS1 DataBar Expanded



GS1 DataBar Expanded Stacked



2D Symbolologies

PDF417



Data Matrix



GS1 Data Matrix



Maxicode

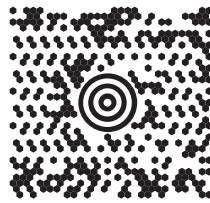

QR Code



GS1 QR



MicroQR



Aztec



0123456789ABCDEFGHIJKLMNOPQRSTUVWXYZ0123456789ABCDEFGHIJKLMNOPQRSTUVWXYZ0123456
7890123456789ABCDEFGHIJKLMNOPQRSTUVWXYZ0123456789ABCDEFGHIJKLMNOPQRSTUVWXYZ0123
456789

Grid Matrix



NOTE Grid Matrix must be enabled to read the following barcode (see [Grid Matrix on page 222](#)).

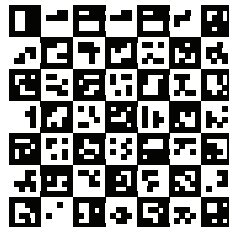

Han Xin



Postal Codes

US Postnet



UK Postal



Japan Postal

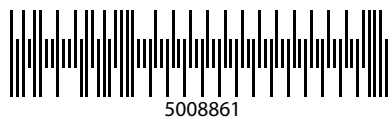

Australian Post



OCR

OCR-A

WFSGH67890

OCR-B

12345ABMKP

MICR E13B

! : 0 1 2 3 || 4 5 6 ... 7 8 9 0 , ' !

US Currency

A barcode consisting of the alphanumeric string "F 01840626 D" printed in green ink on a light-colored background.

F 01840626 D

Index

Numerics

123Scan	39
requirements	40
123scan LED indicators (on scanner)	44
2D bar codes	
aztec	220
aztec inverse	220
code 128 emulation	212
data matrix	213
data matrix inverse	214
data matrix mirror images	215
grid matrix	222
grid matrix inverse	222
grid matrix mirror	223
GS1 data matrix	213
GS1 QR	218
han xin	221
han xin inverse	221
linked QR mode	219
maxicode	216
microPDF417	211
microQR	218
PDF417	211
QR code	216

A

AAMVA field parsing	382
accessories	
cables	24
configurations	24
EAS	47
interface cable	24
partner portal	24
power supplies	24
stands and holders	24
ADF	372
invalid rule	53
transmit error	53
ADF programming indicators	43
advanced data formatting	53, 372

aiming

momentary trigger mode timeout	77
pattern, hand-held	75
pattern, hands-free	76
pattern, snapshot	109
snapshot mode timeout	108
aiming pattern	
orientation	46
ASCII character sets	460
attributes, non-parameter	
beep on next bootup	525
configuration filename	523
date of first programming	523
date of manufacture	523
firmware version	526
host trigger session	526
model number	522
parameter defaults	525
reboot	525
scankit version	526
scanspeed analytics	528
serial number	522
autoexposure	104
aztec bar codes	220
inverse	220
sample	546

B

bar codes	
1D quiet zone level	205
alphanumeric	443
analog gain	106
autoexposure	104
aztec	220
inverse	220
bits per pixel	118
cancel	441
Chinese 2 of 5	191
CJK	
non-CJK UTF bar code output	513
output method	511

unicode output control	510
codabar	180
CLSI editing	182
lengths	180
NOTIS editing	182
start and stop characters	184
codabar security level	183
code 11	168
check digit verification	170
lengths	168
transmit check digits	171
code 128	151
check ISBT table	155
code 128 fnc4	156
GS1-128	153
ISBT 128	154
ISBT concatenation	154
ISBT concatenation redundancy	156
lengths	152
reduced quiet zone	158
security level	157
code 128 emulation	212
code 39	158
check digit verification	162
code 32 prefix	160
convert code 39 to code 32	159
full ASCII conversion	163
lengths	160
reduced quiet zone	165
security level	164
transmit check digit	162
trioptic code 39	159
code 93	165
lengths	166
composite	
beep mode	210
composite CC-A/B	207
composite CC-C	206
composite inverse	207
composite TLC-39	207
GS1-128 emulation mode	210
UPC composite mode	209
continuous bar code read	79
country code page defaults	496
country code pages	500
country codes	481
country keyboard types (country codes)	481
crop to address	110
data matrix	213
data matrix inverse	214
GS1 data matrix	213
mirror images	215
decode session timeout	80
digimarc digital watermarks/dw	371
digital gain	106
disable all code types	132
discrete 2 of 5	177
lengths	178
driver's license parsing	378
AAMVA field parsing	382
driver's license date format	393
driver's license gender format	392
no separator	394
parser version ID	391
parsing field	380
send control characters	395
send keyboard characters	399
set defaults	392
elevel	87
enable all code types	132
enter	88
febraban	175
fixed exposure	105
FN1 substitution values	93
gain and exposure priority for snapshot mode	107
grid matrix	222
grid matrix inverse	222
grid matrix mirror	223
GS1 databar	197
convert to UPC/EAN/JAN	199
GS1 databar expanded	198
GS1 databar limited	198
GS1 databar limited margin check	201
GS1 databar omnidirectional	197
security level	200
han xin	221
inverse	221
IBM	
bar code configuration directive	305
beep directive	304
convert unknown to code 39	304
default table	302
IBM specification version	305
port address	303
IDC	
aspect	359
bits per pixel	360
border type	364
captured image brighten	362
captured image sharpen	363
default table	354
delay time	365
file format selector	359
find box outline	361
height	358
JPEG quality	360
maximum rotation	366
maximum text length	362
minimum text length	361
operating mode	355

- symbology 356
 - width 358
 - X coordinate 357
 - Y coordinate 357
 - zoom limit 365
- illumination 84, 104
- illumination brightness 85
- image brightness (target white) 113
- image capture
 - default table 101
- image cropping 110
- image enhancement 115
- image file format 116
- image rotation 117
- image size 112
- intercharacter gap size 206
- interleaved 2 of 5 171
 - check digit verification 173
 - convert to EAN-13 174, 175
 - lengths 172, 173
 - reduced quiet zone 177
 - security level 176
 - transmit check digit 174
- inverse 1D 195
- JPEG image options 113
- JPEG quality 114
- JPEG size 114
- keyboard wedge
 - alternate numeric keypad emulation 311
 - caps lock override 313
 - convert case 313
 - default table 308
 - FN1 substitution 314
 - function key mapping 314
 - host types 309
 - intra-keystroke delay 310
 - keystroke delay 310
 - quick keypad emulation 311
 - send make and break 315
 - simulated caps lock 312
 - unknown characters 309
- Korean 3 of 5 195
- linked QR mode 219
- macro PDF
 - abort entry 228
 - flush buffer 228
- matrix 2 of 5 191
 - check digit 194
 - lengths 192
 - transmit check digit 194
- maxicode 216
- microPDF417 211
- mobile phone/display mode 82
- motion tolerance 86
- MSI 185
 - check digit algorithm 190
 - check digits 188
 - lengths 186
 - reduced quiet zone 190
 - transmit check digit 188
- numeric 441
- numeric bar codes 441
- OCR
 - check digit 341
 - check digit multiplier 341
 - check digit validation 342
 - default table 318
 - inverse OCR 348
 - lines 329
 - maximum characters 330
 - MICR E13B 326
 - minimum character 329
 - OCR-A 319
 - OCR-A variant 320
 - OCR-B 321
 - OCR-B variant 322
 - orientation 327
 - parameters 319
 - quiet zone 331
 - redundancy 349
 - subset 330
 - template 331
 - US currency serial number 327
- operational modes 103
- PDF prioritization 83
- PDF prioritization timeout 84
- PDF417 211
- pid type 86
- pid value 87
- postal 228
 - Australia post 231
 - Australia post format 232
 - Japan postal 231
 - mailmark 234
 - Netherlands KIX code 233
 - transmit UK postal check digit 230
 - transmit US postal check digit 229
 - UK postal 230
 - UPU FICS postal 234
 - US planet 229
 - US postnet 228
 - USPS 4CB/One Code/Intelligent Mail 233
- prefix/suffix values 90
- product information
 - manufacturing info 54
 - serial number 54
 - software version 54
- QR code 216
 - GS1 QR 218
 - microQR 218

- redundancy level 202
- RS-232
 - baud rate 288
 - beep on bel 296
 - check receive errors 290
 - data bits 290
 - default table 283
 - hardware handshaking 291
 - host serial response timeout 295
 - host types 286
 - intercharacter delay 297
 - nixdorf beep LED options 298
 - parity 289
 - RTS line state 296
 - software handshaking 293, 294
 - stop bits 289
 - unknown characters 298
- samples 535
- scan data options 91
- security level 204
- securPharm 96
- securPharm output formatting 97
- signature capture 119
- signature capture bits per pixel 121
- signature capture file format 120
- signature capture height 122
- signature capture JPEG quality 122
- signature capture width 122
- silence operational mode changes 109
- snapshot aiming pattern 109
- snapshot mode timeout 108
- SSI
 - baud rate 267
 - boot up event 279
 - check parity 270
 - data packet format 273
 - decode event 278
 - host character timeout 275
 - host RTS line state 272
 - host serial response timeout 274
 - interpacket delay 277
 - multipacket option 276
 - parameter event 280
 - parity 269
 - selecting 267
 - software handshaking 271
 - stop bits 270
- symbolologies
 - default table 125
- tab key 88
- timeout between decodes, different symbols 81
- timeout between decodes, same symbol 80
- transmit code ID character 89
- transmit no read message 94
- triggered timeout, same symbol 81
- unique bar code reporting 79
- unsolicited heartbeat interval 95
- UPC/EAN supplemental redundancy 141
- UPC/EAN/JAN
 - bookland EAN 135
 - bookland ISBN 136
 - convert UPC-E to UPC-A 148
 - convert UPC-E1 to UPC-A 148
 - coupon report 150
 - EAN-13/JAN-13 134
 - EAN-8/JAN-8 134
 - ISSN EAN 137
 - supplemental AIM ID format 142
 - supplementals 138
 - transmit UPC-A check digit 143
 - transmit UPC-E check digit 143
 - transmit UPC-E1 check digit 144
 - UCC coupon extended code 149
 - UPC reduced quiet zone 151
 - UPC-A 132
 - UPC-A preamble 145
 - UPC-E 133
 - UPC-E preamble 146
 - UPC-E1 133
 - UPC-E1 preamble 147
 - user programmable supplementals 141
- USB
 - bar code configuration directive 251
 - beep directive 251
 - caps lock override 242
 - convert case 249
 - convert unknown to code 39 243
 - default table 237
 - device type 239, 240
 - fast HID 243
 - function key mapping 248
 - IBM specification version 251
 - keyboard FN1 substitution 247
 - keypad emulation 246
 - keypad emulation with leading zero 247
 - keystroke delay 241
 - polling interval 244
 - quick keypad emulation 246
 - simulated caps lock 248
 - SNAPI handshaking 241
 - static CDC 250
 - unknown characters 242
 - weblink QR 217
- barcodes
 - beep after good decode 63
 - beep duration 67
 - beep tones
 - special tones 66
 - standard tones 65
 - direct decode indicator 70

- hand-held decode aiming pattern 75
 - hand-held trigger mode 74
 - hands-free decode aiming pattern 76
 - low power mode 71
 - momentary trigger mode timeout 77
 - parameter scanning 63
 - picklist mode 78
 - set defaults 62
 - speaker volume 64
 - suppress power up beeps 69
 - time delay to low power mode 72
 - UPC/EAN/JAN
 - EAN/JAN extend 149
 - USB
 - CDC beep on bel 250
 - user preferences
 - default table 60
 - beep
 - duration 67
 - beep tone adjustment
 - special beep tones 66
 - standard beep tones 65
 - beeper
 - beep after good decode 63
 - suppress on power up 69
 - beeper indicators
 - 123scan host specific 44
 - ADF programming 43
 - image capture 42
 - macro PDF 44
 - maintenance 44
 - parameter programming 43
 - RS-232 host specific 43
 - scanning 42
 - SMS 44
 - USB host specific 43
- C**
- cables
 - inserting 31
 - interface 24, 33
 - removing 32
 - signal descriptions 58
 - character sets
 - ALT key 465
 - ASCII 460
 - extended key 469
 - F key 468
 - GUI key 466
 - numeric key 468
 - PF key 467
 - Chinese 2 of 5 bar codes 191
 - sample 541
 - CJK 510
 - control parameters 510
 - country keyboard missing characters 513
 - decode setup 514
 - input method 516
 - cleaning the devices
 - approved for standard devices 49
 - how to 50
 - known harmful ingredients 49
 - codabar bar codes 180
 - CLSI editing 182
 - lengths 180
 - NOTIS editing 182
 - security level 183
 - start and stop characters 184
 - code 11 bar codes 168
 - check digit verification 170
 - lengths 168
 - sample 540
 - transmit check digits 171
 - code 128 bar codes 151
 - check ISBT table 155
 - fnc4 156
 - GS1-128 153
 - ISBT 128 154
 - ISBT concatenation 154
 - ISBT concatenation redundancy 156
 - lengths 152
 - reduced quiet zone 158
 - sample 538
 - security level 157
 - code 128 emulation bar codes 212
 - code 39 bar codes 158
 - check digit verification 162
 - code 32 prefix 160
 - code 39 security level 164
 - convert code 39 to code 32 159
 - full ASCII conversion 163
 - lengths 160
 - reduced quiet zone 165
 - sample 535, 539
 - transmit check digit 162
 - trioptic 159
 - code 93 bar codes 165
 - lengths 166
 - sample 539
 - code identifiers
 - AIM 472
 - modifier characters 473
 - Symbol 471
 - transmitting 89
 - communication protocol
 - cable interface 478
 - composite bar codes
 - beep mode 210
 - composite CC-A/B 207

composite CC-C	206
composite inverse	207
composite TLC-39	207
GS1-128 emulation mode	210
UPC composite mode	209
configurations	
accessories	24
cables	24
scanner	23
stands and holders	24
connecting	
IBM interface	301
interface cable	31
keyboard wedge interface	307
power	33
RS-232 interface	282
USB interface	236
conventions	
notational	26
country code pages	500
defaults	496
country codes	481
cropping images	110
custom tone	423
D	
data matrix bar codes	213
data matrix inverse	214
GS1 data matrix	213
mirror images	215
sample	546, 547, 548
data parsing	375
decode ranges	47
default parameters	60
all	426
DL parsing	377
IBM	302
IDC	354
image capture	101
keyboard wedge	308
OCR	318
RS-232	283
setting	62
SSI	266
USB	237
user preferences	60
digimarc digital watermarks/dw	371
discrete 2 of 5 bar codes	177
lengths	178
downloading custom tone	
via scanner SDK	423
driver's license parsing	
AAMVA field parsing	382
ADF example	417
bar codes	378
control characters	395
data fields	379
date format	393
default parameters	377
field parsing bar codes	380
gender format	392
keyboard characters	399
no separator	394
parser version ID	391
rule example	413
E	
EAS	47
elevel	87
error indications	
ADF	53
format	53
input	52
exposure options	
analog gain	106
autoexposure	104
digital gain	106
fixed exposure	105
gain and exposure priority for snapshot mode	107
illumination	84, 104
F	
features, scanner	
LED	30
firmware	
flash update	87
G	
gain	
analog	106
digital	106
grid matrix bar codes	
sample	546
gs1 data matrix bar codes	
sample	545
GS1 databar bar codes	197
convert GS1 databar to UPC/EAN/JAN	199
GS1 databar expanded	198
GS1 databar limited	198
GS1 databar limited margin check	201
GS1 databar omnidirectional	197
sample	542
security level	200
GS1 QR bar codes	
sample	545

H

han xin bar codes	221
inverse	221
sample	547
host specific indicators	
123scan	44
RS-232	43
USB	43
host types	
IBM	303
keyboard wedge	309
RS-232	286
SSI	267
USB	239

I

IBM	
bar codes	303
connection	301
default parameters	302
IDC	350
bar code acceptance test	351
bar codes	355
capture region	351
data transmission	352
default parameters	354
demonstrations	368
image post processing	352
operating mode	352
quick start	367
quick start form	369
sample setup	367
support	352
illumination	84, 104
brightness	85
image capture	
default parameters	101
operational modes	103
image capture beeper and LED indicators	42
image options	
bits per pixel	118
cropping	110
file formats	116
image brightness (target white)	113
image enhancement	115
image rotation	117
image size	112
JPEG image options	113
JPEG quality	114
JPEG size	114
signature capture	119
signature capture file format	120
information, service	27

interface

cables	24
interleaved 2 of 5 bar codes	171
check digit verification	173
convert to EAN-13	174
febraban	175
lengths	172, 173
reduced quiet zone	177
sample	540
security level	176
transmit check digit	174

J

JPEG image options	113
quality	114
size	114

K

keyboard types (country codes)

Albanian	481
Arabic (101)	481
Arabic (102)	482
Arabic (102) Azerty	482
Azeri (Cyrillic)	482
Azeri (Latin)	482
Belarusian	482
Bosnian (Cyrillic)	482
Bosnian (Latin)	482
Bulgarian (Latin)	483
Bulgarian Cyrillic (Typewriter)	483
Canadian French (Legacy)	483
Canadian French Win7	483
Canadian Multilingual Standard	483
Chinese (ASCII)	483
Chinese (Simplified)	484
Chinese (Traditional)	484
Croatian	484
Czech	484
Czech (Programmer)	484
Czech (QWERTY)	484
Danish	484
Dutch (Netherlands)	485
Estonian	485
Faeroese	485
Finnish	485
French (Canada) 2000/XP	486
French (Canada) 95/98	485
French (France)	485
French International	485
Galician	486
German	486
Greek	486
Greek (220) Latin	486

Greek (319) Latin	486
Greek 220	487
Greek 319	487
Greek Latin	486
Greek Polytonic	487
Hebrew Israel	487
Hungarian	487
Hungarian_101KEY	487
Irish	488
Islandic	487
Italian	488
Italian (142)	488
Japanese (ASCII)	488
Japanese (SHIFT-JIS)	488
Kazakh	488
Korean (ASCII)	488
Korean (Hangul)	489
Kyrgyz	489
Latin American	489
Latvian	489
Latvian (QWERTY)	489
Lithuanian	489
Lithuanian (IBM)	489
Macedonian (FYROM)	490
Maltese_47KEY	490
Mongolian	490
Norwegian	490
Polish (214)	490
Polish (Programmer)	490
Portuguese (Brazil)	490
Portuguese (Brazilian ABNT)	491
Portuguese (Brazilian ABNT2)	491
Portuguese (Portugal)	491
Romanian	491
Romanian (Legacy)	491
Romanian (Programmer)	492
Romanian (Standard)	491
Russian	492
Russian (Typewriter)	492
Serbian (Cyrillic)	492
Serbian (Latin)	492
Slovak	492
Slovak (QWERTY)	493
Slovenian	493
Spanish	493
Spanish (Variation)	493
Swedish	493
Swiss French	493
Swiss German	493
Tatar	494
Thai (Kedmanee)	494
Turkish F	494
Turkish Q	494
UK English	494
Ukrainian	494
US Dvorak	494
US Dvorak Left	495
US Dvorak Right	495
US English	481
US International	495
Uzbek	495
Vietnamese	495
keyboard wedge	
bar codes	309
connection	307
default parameters	308
keyboard map	315
Korean 3 of 5 bar codes	195
sample	541
L	
LED indicators	
123scan host specific	44
ADF programming	43
image capture	42
macro PDF	44
maintenance	44
parameter programming	43
RS-232 host specific	43
scanning	42
SMS	44
USB host specific	43
M	
macro PDF	227
abort entry	228
flush buffer	228
macro PDF beeper and LED indicators	44
maintenance	49
approved cleaners for standard devices	49
how to clean the devices	50
known harmful ingredients	49
matrix 2 of 5 bar codes	191
check digit	194
lengths	192
sample	541
transmit check digit	194
maxicode bar codes	216
MDF	372
microPDF417 bar codes	211
microQR code bar codes	
sample	546
mounting	
wall	24
MSI bar codes	185
check digit algorithm	190
check digits	188
lengths	186

- reduced quiet zone 190
 - sample 540
 - transmit check digit 188
 - multicode data formatting 372
- N**
- non-parameter attributes
 - beep on next bootup 525
 - configuration filename 523
 - date of first programming 523
 - date of manufacture 523
 - firmware version 526
 - host trigger session 526
 - model number 522
 - parameter defaults 525
 - reboot 525
 - scankit version 526
 - scanspeed analytics 528
 - serial number 522
- O**
- OCR
 - bar codes 319
 - default parameters 318
- P**
- parameter programming indicators 43
 - partner portal 24
 - PDF417 bar codes 211
 - PDF prioritization 83
 - sample 544
 - pinouts
 - scanner signal descriptions 58
 - postal code bar codes 228
 - Australia post 231
 - Australia post format 232
 - Japan postal 231
 - mailmark 234
 - Netherlands KIX code 233
 - sample 547
 - transmit UK postal check digit 230
 - transmit US postal check digit 229
 - UK postal 230
 - UPU FICS postal 234
 - US planet 229
 - US postnet 228
 - USPS 4CB/One Code/Intelligent Mail 233
 - power supplies 24
 - power supply
 - connecting 33
 - preferred symbol 375
 - product id (pid) value 87
 - product id type 86
 - product information
 - manufacturing info 54
 - report software version 54
 - serial number 54
- Q**
- QR code bar codes 216
 - GS1 QR 218
 - microQR 218
 - sample 546, 547, 548
- R**
- related documents 27
 - related software 27
 - RS-232
 - bar codes 286
 - connection 282
 - default parameters 283
 - host parameters 284
 - RSM
 - commands and responses over SSI 263
- S**
- sample bar codes
 - aztec 546
 - Chinese 2 of 5 541
 - code 11 540
 - code 128 538
 - code 39 535, 539
 - code 93 539
 - data matrix 546, 547, 548
 - grid matrix 546
 - gs1 data matrix 545
 - GS1 databar 542
 - GS1 QR 545
 - han xin 547
 - interleaved 2 of 5 540
 - Korean 3 of 5 541
 - matrix 2 of 5 541
 - microQR code 546
 - MSI 540
 - PDF417 544
 - QR code 546, 547, 548
 - UK postal 547
 - UPC/EAN 535
 - US postnet 547
 - scanning
 - aiming 46
 - scanning beeper and LED indicators 42
 - scanspeed analytics 529
 - security

- 1D quiet zone level 205
 - intercharacter gap size 206
 - redundancy level 202
 - security level 204
 - service information 27
 - setting defaults 62
 - setup
 - connecting a keyboard wedge host 307
 - connecting a USB interface 236
 - connecting an IBM most 301
 - connecting an RS-232 interface 282
 - connecting power 33
 - inserting interface cable 31
 - unpacking 29
 - signal descriptions 58
 - signature capture 119
 - bits per pixel 121
 - code structure 518
 - data format 520
 - dimensions 520
 - file format selector 120
 - height 122
 - JPEG quality 122
 - signature boxes 521
 - start and stop patterns 519
 - width 122
 - SMS LED indicators (on scanner) 44
 - software tools
 - 123Scan 39
 - ADF 372
 - MDF 372
 - preferred symbol 375
 - speaker
 - speaker volume 64
 - specifications 55
 - SSI
 - bar codes 267
 - commands 257
 - communications 256, 260
 - data transmission 259
 - default parameters 266
 - event reporting 278
 - handshaking 258, 260
 - low power mode 262
 - RSM commands and responses 263
 - RTS CTS 260
 - transactions 258
 - sybologies
 - bar codes 132
 - default parameters 125
- T**
- technical specifications 55
 - tone
 - customizing 423
 - trigger mode, hand-held 74
 - troubleshooting 51
- U**
- unicode
 - output control 510
 - unpacking 29
 - UPC/EAN bar codes
 - supplemental redundancy 141
 - UPC/EAN/JAN bar codes
 - bookland EAN 135
 - bookland ISBN 136
 - convert UPC-E to UPC-A 148
 - convert UPC-E1 to UPC-A 148
 - coupon report 150
 - decode supplementals 138
 - EAN-13/JAN-13 134
 - EAN-8/JAN-8 134
 - ISSN EAN 137
 - samples 535
 - supplemental AIM ID format 142
 - transmit UPC-A check digit 143
 - transmit UPC-E check digit 143
 - transmit UPC-E1 check digit 144
 - UCC coupon extended code 149
 - UPC reduced quiet zone 151
 - UPC-A 132
 - UPC-A preamble 145
 - UPC-E 133
 - UPC-E preamble 146
 - UPC-E1 133
 - UPC-E1 preamble 147
 - user programmable supplementals 141
 - UPC/EAN/JAN barcodes
 - EAN/JAN zero extend 149
 - USB
 - bar codes 239
 - connection 236
 - default parameters 237
- W**
- weblink QR code bar codes 217

